

THE POWER OF FASTENING



BeA Professional Tools and Fastening Systems

Catalogue

The complete range for distributors, craftsmen and industry

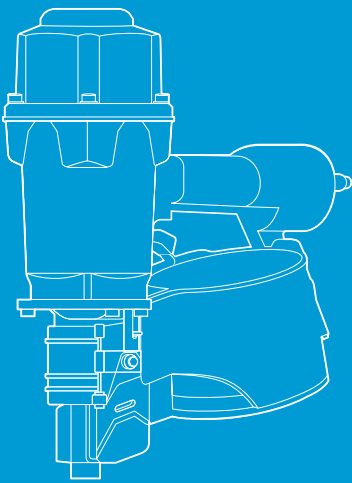

BeA Tools and Fasteners – The complete range of fastening solutions for industry

The company Joh. Friedrich Behrens AG (BeA) was founded in 1910. In more than 100 years of its existence, it has developed into a global group with a total turnover of over 120 million euros, achieving market leadership throughout Europe in the fastening technology field.

The BeA trademark stands for top of the range products in the fastening technology field. BeA compressed air nail guns and fasteners are characterised by top quality and reliability. In order to maintain these high standards in the future, we are constantly optimising and expanding our product range. By using innovative technologies, BeA sets the standards in fastening technology.

BeA tools and fasteners are easy to use and perform with excellent results. They speed up your manufacturing process and are more economical. Our tools are tested in various tough environments.

Joh. Friedrich Behrens AG

Industrial Fastening Systems
Bogenstraße 43 - 45
22926 Ahrensburg
Germany
Tel.: + 49 (0) 41 02 78 - 445
Fax: + 49 (0) 41 02 78 - 270
info@behrens-group.com
www.bea-group.com



BeA Headquarter Ahrensburg / Germany

Please visit www.bea-group.com to learn more about BeA Professional Tools and Fastening Systems or call: +49 (0) 4102 78 - 445

BeA is a member of the following associations:



BeA – the strong partner in the

More power and even more products

BeA Autotec - New Tools

BeA «Pusher»
for Nails 0° TCIN



BeA 246/284 SL
for Staples 246
(100 - 160 mm)



BeA 346/284 SL
for Staples 346 (160 - 200 mm)



(further information on page 15, 113)

Autotec strip nailer type 296 with reloading nail type 297

Reloading of the nails into the magazine happens automatically utilizing a cassette type holding bay. This cassette has a capacity of 90 strips (equals approx. 1.800 nails). For a quick change from one nail length to a different nail length additional cassettes are available which can be preloaded whilst not in use. Filling of the nail cassette (straight out of the carton) is possible in no time. The loading station automatically senses the position of the nail head and feeds it correctly into the magazine of the nailer. (further information on page 110)

Applications

Crating, heavy duty wooden packaging (pallets etc.) and prefabricated housing industry



Skater for heavy duty staples

Skater 14/65-830 C and Skater 180/65-835 C

The BeA skaters are ideal for stapling down gypsum boards, wooden boards (OSB, MDF, etc.). Stapler options for the skater are models 14/65-830C and 180/65-835C. Both the front and the rear handle come with actuation triggers which allow stapling of boards up to 3 meters with two operators. Additional features are a dry firing control, a quick release for staples and a rotatable air exhaust. Both skater models achieve fast and precise stapling according to Eurocode 5. (further information on page 41, 42 and 114)



Skater for coil nails

Skater 800 DC

In addition to the above skaters BeA also developed a skater using the robust coil nailer type 800 DC for Wire collated nails. The Skater 800 DC is used for wooden crates and in the prefab housing industry. (further information on page 41, 42 and 114)



and reliable fastening industry

Highest Quality + ideal solutions



Pneumatic nailer with two hand system BeA 570 DC and 102 DC

BeA has developed a nailer with a two handed system, in order to match the new security stipulations. The new double handed actuation system makes sure that the worker permanently has his two hands on the tool (please see pages 59 & 68 for more information).



Cordless wide crown staplers 246/100-670E

The already wide range of cordless tools has been enlarged with another tool. The BeA 246/100-670E is the first of its kind in the world firing staple type 246 (65 - 100 mm length). This extra light tool was developed for the use on the building sites, e.g.: for stapling on insulation materials (please see page 24 for more information).

BeA nailplates

BeA nailplates and calculation software for the industrial roof truss and other wooden framework (see pages 12 and 13).

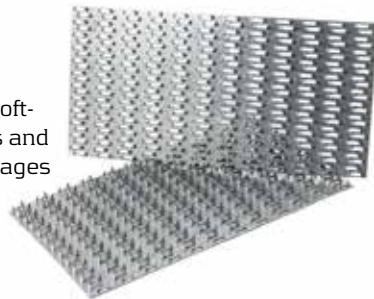

Cordless metal roofing nailer R35-654E

The new cordless tool for sheet metal clips is well balanced and light. This nailer uses plastic collated strip nails from 22 - 35mm. It is an essential and flexible tool for nailing down connectors on various types of metal roofs (please see page 24 for more information).



Saber saw blades

BeA Recipro saber saw blades are specifically used by pallet repair shops and for wooden packages. These long lasting saber blades easily saw through timber and/or steel. BeA saber saw blades fit into all common saws (further information on page 6 and 7).



Many different applications – ideal solutions – one supplier
GET SUPPLIED FROM ONE SOURCE

- High quality standard
- Certified products
- Warehousing and fast delivery times
- Expert consultation on site
- Optimal and custom made solutions
- Stringent quality management
- Less administration



Reciprocating Saber Saw Blades

BeA Recipro saber saw blades are specifically used by pallet repair shops and for wooden packages. These long-lasting saber blades easily saw through timber and/or steel. BeA Recipro blades fit into all common saws.

- Extremely durable Bi-Metal welded blades
- Universal feed
- Vario teething especially for nail embedded wood

Applications

Pallet repairs, nail embedded wood



Technical Data

Item Code	Description	Dimensions	Teething	Tip
11700001	Recipro 200x0.9x19 VTNT	200x0.9x19 mm	Vario-Teething (10-14 TPI)	Normal sharp tip
11700002	Recipro 230x0.9x19 VTNT	230x0.9x19 mm	Vario-Teething (10-14 TPI)	Normal sharp tip
11700003	Recipro 200x1.25x19 VTNT	200x1.25x19 mm	Vario-Teething (10-14 TPI)	Normal sharp tip
11700004	Recipro 230x1.25x19 VTNT	230x1.25x19 mm	Vario-Teething (10-14 TPI)	Normal sharp tip
11700011	Recipro 230x0.9x19 WTNT	230x0.9x19 mm	Wood-Teething (10 TPI)	Normal sharp tip
11700018	Recipro 190x1.25x19 VVRT	190x1.25x19 mm	Vario-Teething (10-14 TPI)	Reverse sharp tip
11700020	Recipro 200x0.9x19 WTNT	200x0.9x19 mm	Wood-Teething (10 TPI)	Normal sharp tip
11700021	Recipro 200x1.25x19 WTNT	200x1.25x19 mm	Wood-Teething (10 TPI)	Normal sharp tip
11700023	Recipro 190x0.9x19 VVRT	190x0.9x19 mm	Vario-Teething (10-14 TPI)	Reverse sharp tip
11700024	Recipro 225x0.9x19 VVRT	225x0.9x19 mm	Vario-Teething (10-14 TPI)	Reverse sharp tip
11700025	Recipro 225x1.25x19 VVRT	225x1.25x19 mm	Vario-Teething (10-14 TPI)	Reverse sharp tip

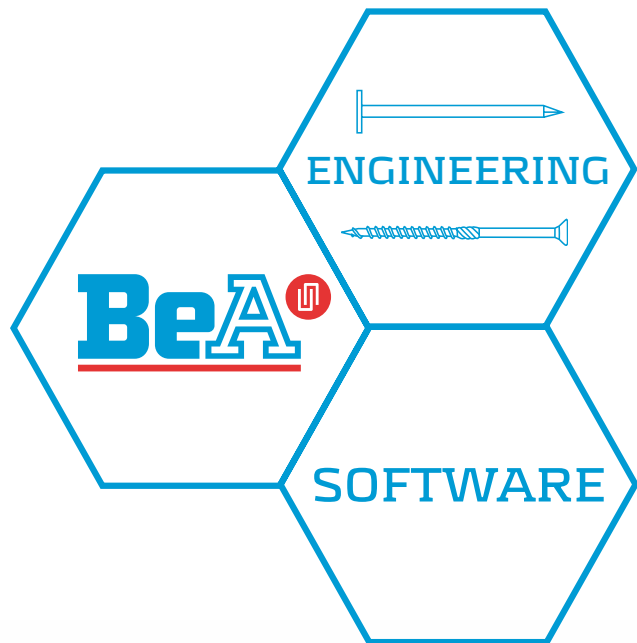

Calculation software as per Eurocode 5 for nails and screws

Download the range free of charge: <http://software.bea-group.com>

BeA Engineering Software

4 calculation methods

Roof insulation with BeA nails



Roof insulation with BeA screws



Montage wood/wood with BeA nails



Montage wood/wood with BeA screws

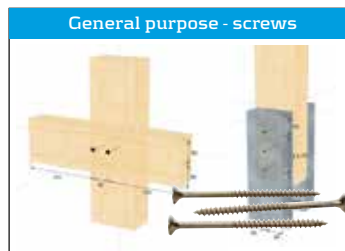

Key benefits

- Conforms to current industry standards
- Intuitive user interface
- Fast, manageable data capture
- Shows the entire range
- Detailed display of results
- Manageable, easy to understand evaluation
- Order quantities with article number
- Direct order option / email from the program
- Software can operate with a range of national standards/appendices (Switzerland, Austria, France etc.)
- Insulation panel manufacturers STEICO, PAVATEX by Soprema, Gutex, best wood SCHNEIDER with direct product selection
- Increased profitability
- Available in a range of languages
- Download the range free of charge: <http://software.bea-group.com>

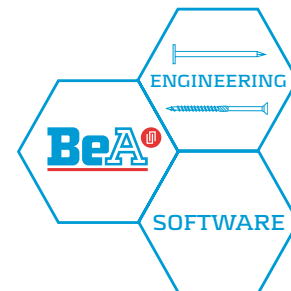

User friendly operation

Design of elements



Quantification of loads



Optimisation of selection of fixings



Records and results certificates





For making
stable and sturdy
packaging crates

BeA VTI connectors

Simple, fast, stable, cost efficient, protected as utility model

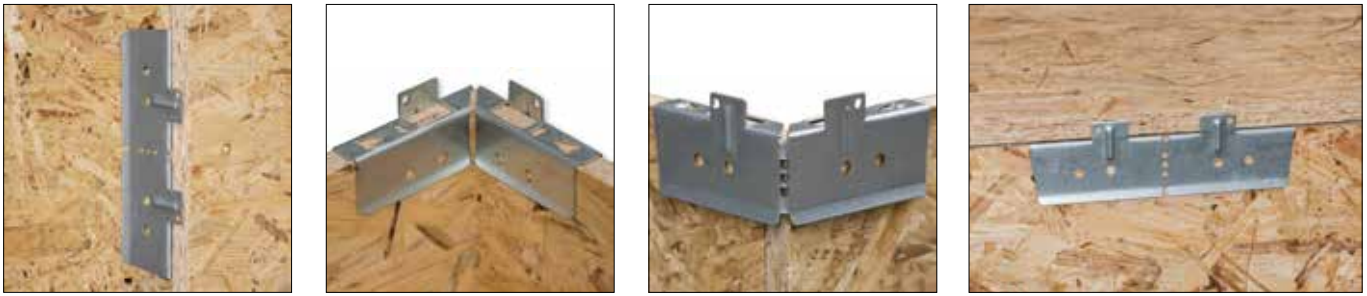

- World first for quick and easy crate assembly
- Only one component for long sides and corners
- Simple to use without tool
- Sturdy hot dip galvanised version, high load bearing capacity
- For 12 and 15 mm board materials e.g. OSB panels, plywood, chipboard, honeycomb core cardboard
- Protected as utility model
- Made in Germany
- The BEA VTT connector for making stable and sturdy packaging crates
- Use of low priced board material (e.g. OSB panels, plywood, chipboard, honeycomb core cardboard)
- Fast construction time (120 sec), significant cost and time saving
- Connectors can be used without the aid of a tool
- No milled, drilled or grooved profiles in the board parts
- Can be reused / mono material recycling

construction
time
(120 sec.)



1
BeA crate set with BeA VTT connectors

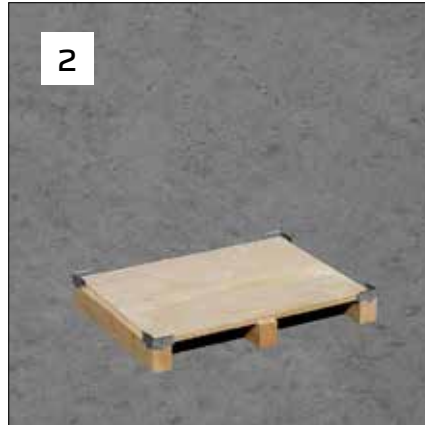

2
Pallet as a basis with BeA VTT connectors



3
Simple insertion of the crate sides

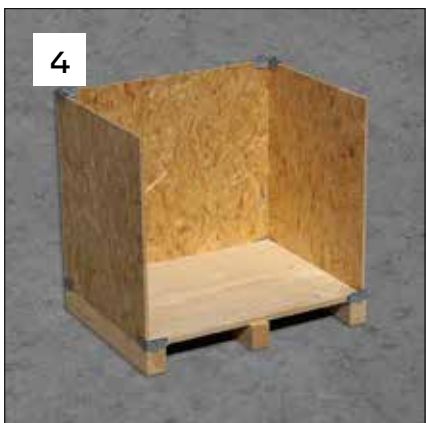

4
The crate can be filled at any time



5
Fit the BeA VTT connectors at the top



6
Set the lid in place, seal using packaging strap



ARCTEC

Software solution for
a statistical calculation of
our nailplates

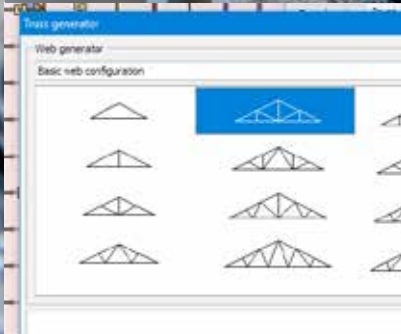

BeA Nailplates



BeA Nailplates

BeA nailplates with CE identifier are made from S280GD and optionally available with a Z275 galvanisation. Other features (e.g.: stainless steel) are also available, and can be applied on agreement.

- Versatile
- Optimal connections and materials utilisation
- High load bearing capacity
- Prevents splitting
- Various nail lengths and plate thicknesses applicable, recording to a statistical calculation



Applications

Farm buildings, halls, workshops, consumer markets, administrative and office buildings, housing, formworks, roof refurbishment, building extensions, single and multi family housing, special construction and the reinforcement of all types of joints, packaging materials etc.



BeA supplies nailplates of 1mm, 1.5 mm and 2 mm thick sheetmetal in a huge range of measurements. Please contact us and ask for our nailplates information brochure: Tel. +49(0)4102-78 275 or arctec@behrens-group.com

Nailplate Binder

- Triangle binder
- Aisle truss binder
- Studio binder

Packaging

- Crate reinforcement
- Longitudinal connector
- Pallet block reinforcement

Prevention of wood splitting during



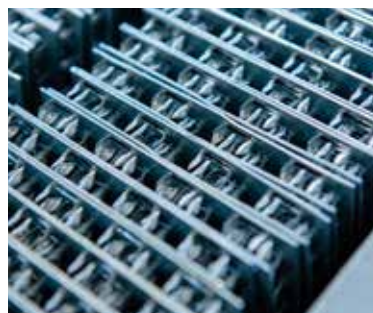



- Construction with tropical wood
- Thin wooden cross section



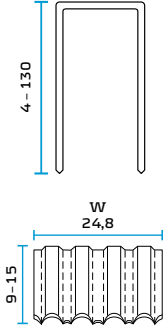

BeA Autotec Automation technology

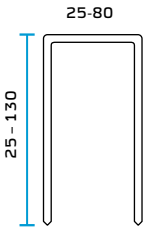
	Description	Capacity	Length from - to in mm	Fastener Type
	<p>New</p> <p>BeA Autotec Pusher</p>	1000	35-50	
	<p>New</p> <p>246/284 SL BeA Autotec with changeover cassette</p>	550	75-160	
	<p>New</p> <p>346/284 SL BeA Autotec with changeover cassette</p>	600	200	
	<p>235/245/265/285 BeA Autotec long magazine</p>	100-500	4-200	

	Description	Capacity	Length from - to in mm	Fastener Type
	232/242/262/282 BeA Autotec Side loader	up to 2.300	4-130	
	BeA Autotec Top loader	10.000	4-65	
	264/284 BeA Autotec with changeover cassette	up to 2.300	25-80	
	258/268/288 BeA Autotec for BDC jumbo coils	up to 900	30-100	

	Description	Capacity	Length from - to in mm	Fastener Type
	<p>238/248/268/270 BeA Autotec Strip nailer</p>	<p>up to 400</p>	<p>12-160</p>	
	<p>235/246/266/296 BeA Autotec robot nailer with reloading station 237/247/267/297</p>	<p>up to 25000</p>	<p>6-160</p>	
	<p>239 BeA Autotec stationary clinching unit</p>	<p>up to 500</p>	<p>4-25</p>	

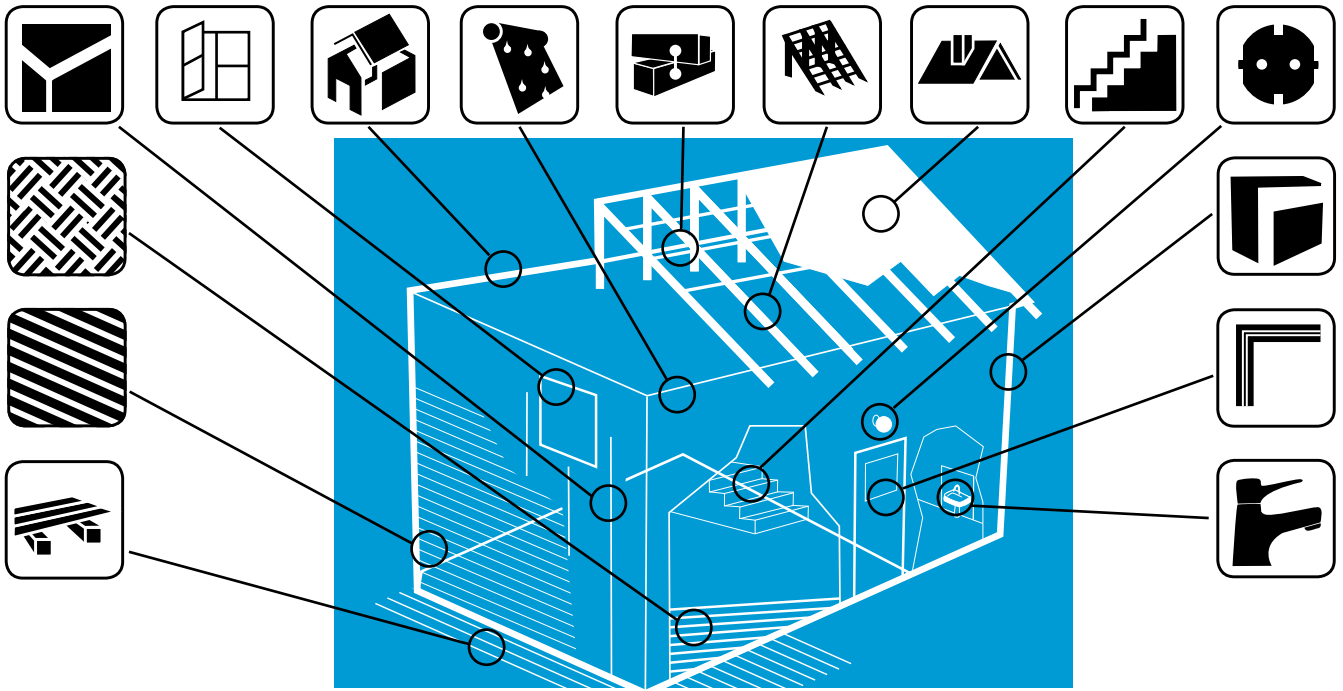

Construction

Application	Fasteners	Page	Application	Fasteners	Page	
	Exterior Cladding			Roofing		
	Staple type 14	31, 32, 34, 39		Staple type 155	32, 34, 39, 40	
	Staple type 180	33, 35		BDC Nails	53-64	
	Brad type SKDA 600	20, 50		D Head Nails 34°	16, 68	
	BDC Nails	53-64		R20 Strip Nails	66, 69-71	
	Inner Construction			Roof Truss		
	Staple type 97	27		R20 Strip Nails	66, 67-71	
	Staple type 90	29		D Head Nails 34°	16, 68	
	Staple type 92	30		BDC Nails	53-64	
	Staple type 16/155	32, 34, 39, 40			Gypsum Boards	
Brad type SK 200	46	Staple type 14	31, 32, 34, 39			
Brad type SK 300	40, 47, 19, 75	Staple type 16/155	32, 34, 39, 40			
	Door Frames		Staple type 180		33, 35	
	Brad type SK 200	46	BDC Nails		53-64	
	Brad type SK 300	40, 47, 19, 75	R20 Strip Nails	66, 69-71		
	Brad type SKAM 300	48	D Head Nails 34°	16, 68		
	Brad type SKAM 400	49		Insulation		
Brad type RSK 500	49	Staple type 95		26		
	Stairs			Staple type 80/380	23, 24, 43	
	T Nails	40, 51		Staple type 140	37	
	Brad type RSK 500	49		Staple type 246	18, 37	
	Brad type SKDA 600	20, 50	Staple type 346	38		
	Brad type SKAM 400	49	Roofing Nails	65		
	Flooring, Hardwood Floors			Bathrooms		
	Staple type 14	31, 32, 34, 39		Concrete Nail Type CN	21, 22	
	Staple type 180	33, 35		T Nails	40, 51	
	BDC Nails	53-64			Electrical Installations	
	Brad type RSK 500	49			Concrete Nail Type CN	21, 22
Brad type SKDA 600	20, 50	Cable Clips	74			
	Decks				Windows & Doors	
	TC Nails	65-67			Brad type SK 300	19, 40, 47, 75
	Screws	78-79		Brad type SK 400	19, 48	
	BDC Nails	53-64		Pins S 500 Alu	49	
		Interior Trim			Brad type SKAM 300	48
Brad type SK 300		19, 40, 47, 75	Brad type SKAM 400	49		
Brad type SKAM 300		48	Brad type SKDA 600	20, 50		
Brad type SKDA 600		20, 50		Timber Connectors		
Steel brad type SKS 600		50		Anchor Nails	17, 66, 67	



Furniture

Application	Fasteners	Page
Chairs and Seats	Staple type 71	25
	Staple type 92	30
	Staple type 80/380	23, 24, 43
	RapidClip	72, 73
	Hog Ring	44
	Decorative nails	75
Cabinets	Pins S 100	46
	Brad type SK 200	46
	Brad type SKAM 300	48
	Collated Screws	78
	Brad type SK 300	40, 47, 19, 75
	Staple type 97	27
	Staple type 92	30

Application	Fasteners	Page
Beds	Staple type 80/380	23, 24, 43
	Staple type 94	30
	Staple type 98	28
	BDC Nails	53-64
	Staple type 14	31, 32, 34, 39

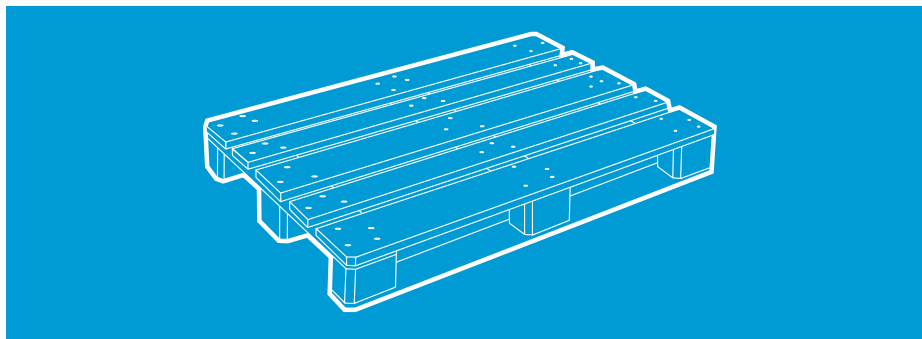

Packaging

Application	Fasteners	Page
Packaging	Carton Closing Staples Packfix	41
	Carton Closing Staples Clincher	41
	Staple type 95	26, 42
	Staple type 195	43
	Staple type 42	36
	Hotmelt Sticks	95-97
	Crates	Staple type 94
Staple type 14		31, 32, 34, 39
Staple type 155		32, 34, 39, 40
Staple type 180		33, 35
BDC Nails		53-64
R20 Strip Nails		66, 69-71
D Head Nails 34°		16, 68
RP Nails 20°		71
XL Packaging programm		80-92

Application	Fasteners	Page
Small Crates	Staple type 90	29
	Staple type 92	30
	Staple type 94	30
	Staple type 14	31, 32, 34, 39
	Staple type 16	32, 34, 39, 40
	Brad type SK 300	19, 40, 47, 75
	Brad type SKAM 300	48
	Brad type SK 400	19, 48
Pallets	T Nails	40, 51
	Staple type 14	31, 32, 34, 39
	BDC Nails	53-64
	EPAL Dome Head Ring Nails	57, 64
	RECIPRO Saber saw blades	60

BeA Nomenclature

BeA Tool description



14/32 - 613

Shank properties

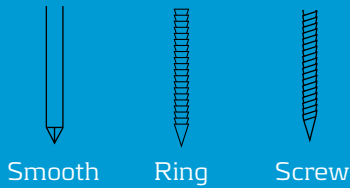

Material

- BK = Steel, bright
- NK = Steel, electro galvanized
- NK Hard = Steel, galvanized, hard
- NKS = Steel, galvanized, extra hard
- FV = steel, hot-dipped galvanized
- VZ = Steel, heavy electro-galvanized
- LM = Aluminium
- A2 = Stainless steel, comparable to material 1.4301
- A4 = Stainless steel, comparable to material 1.4401
- KU = Copper
- MS = Brass

Surface properties

- HZ = Steel, resin coated to attain higher withdrawal values
- Ring = Ring Shank
- Screw = Screw Shank
- NG = Screw Nail

Standard: all BeA Staples, SK Brads and Pins are manufactured with chisel point, except type 346

Standard: all BeA BDC and Strip Nails are manufactured with diamond point

Staple and nail points

- DP = Divergent point, staple legs divert sideways away from the crown
- IA = Inside chisel point: staple legs turn inwards
- AA = Outside chisel point: staple legs turn outwards
- CD = Rebated edge for gypsum fire board
- SS = Blunt point
- NI = Clinch point

BeA certificates and classifications

BeA staple type 155 (38mm-65mm) in VZ HZ and NR HZ and BeA staple type 180 (40mm-80mm) in VZ HZ and NR HZ are in compliance with DIN 1052 part 2 and the general building inspection code.



All fasteners available from BeA that are used in building load bearing structures have the characteristics specified in Eurocode 5.

The complete required CE labels according to EN 14592 can be downloaded as pdf files here: <http://www.bea-group.com/ce>.

For the planning of structural framework according to EN 1995-1-1 you can take the necessary details from these documents.



BeA is a partner of the European Pallet Association and is approved to manufacture EPAL dome head ring Nails.



All BeA Pneumatic tools are in compliance with safety regulations as outlined in the EG machinery directive 2006/42/EG and are labelled with the CE mark.

Service Classes



BeA Staple points

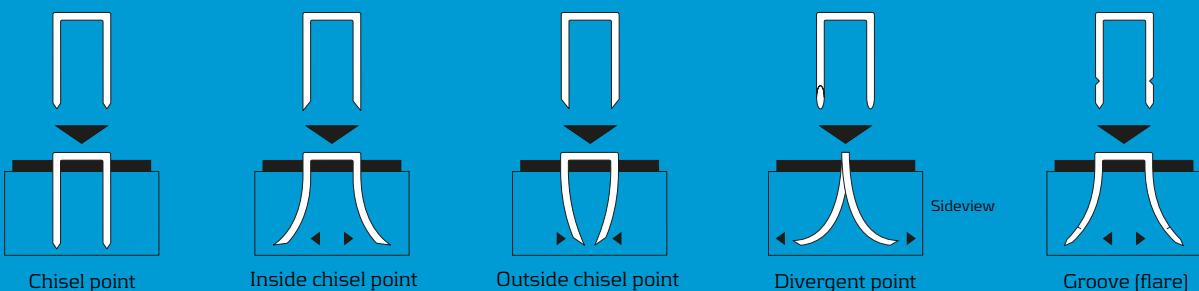

Contents

	Page
BeA Service and BeA International	2-3
BeA News	4-5
Reciprocating Saber Saw Blades	6-7
Calculation software as per Eurocode 5 for nails and screws	8-9
BeA VTT connectors	10-11
BeA Nailplates	12-13
BeA Autotec Automation technology	14-17
BeA Applications	18-19
BeA Nomenclature and Content	20-21
BeA Cordless Tools	<i>D Head Nails / Anchor Nails / Wide Crown Staples / Sheet Metal Clips</i> 22-24
BeA Cordless Tools	<i>Brads Nails SK 300 / SK 400 / SKDA 600</i> 25-26
BeA Cordless Concrete Tools	<i>Steel Nail type CN</i> 27-28
BeA Staplers	<i>Staple type 80/380 / 71 / 72 / 95 / 74 / 97 / 98</i> 29-34
BeA Staplers	<i>Staple type 90 / 92 / 94</i> 34-36
BeA Staplers	<i>Staple type 14 / 16 / 155 / 180 / 200</i> 37-40
BeA Skater for Staples	<i>Staple type 14 / 16 / 155 / 180</i> 40-41
BeA Staplers	<i>Wide Crown Staple type 42 / 146 / 140 / 246 / 346</i> 42-44
BeA EPAL Staplers	<i>EPAL Staple type 33</i> 44
BeA Variant Tools	<i>Staple type 14 / 16 / 155 / 99 / T Nails and Brads</i> 45-46
BeA Carton Closing Staplers	<i>Carton Closing Staple type Packfix</i> 47
BeA Stapler for Plastic Staples	<i>Plastic Staple type</i> 48
BeA Pliers	<i>Staple type 95 / 380 / 195 and Metal Clips</i> 48-49
BeA Hog Ring Pliers	<i>Hog Rings</i> 50
BeA Hand and Hammer Tackers	<i>Staple type 37 / A 11 / 53</i> 50-51
BeA Pinners	<i>Pins S 700 / S 100</i> 52
BeA Brad Nailers	<i>Brad type SK 200 / 300 / 400 / 500 / SKAM 300 / SKAM 400</i> 52-55
BeA Brad Nailers	<i>Brad type SKDA 600 / SKS 600</i> 56
BeA T Nailers and BeA Nailers for Corrugated Fasteners	<i>T Nails and Fasteners type WM / W / Maxi W</i> 57-58
BeA Coil Nailers	<i>Wire Collated BDC Nails and Plastic Collated TC Nails</i> 59-66
BeA Saber Saw blades RECIPRO	66
BeA Skater and BeA Coil Nailers	<i>Wire Collated BDC Nails</i> 68-70
BeA Coil Nailers	<i>Roofing Nail Type DPN</i> 71
BeA Coil Nailers	<i>Plastic Collated TC Nails</i> 71
BeA Anchor Nailers	<i>TC Anchor Nails / R20 Anchor Nails / R34 Anchor Nails</i> 72-73
BeA Strip Nailers	<i>Paper Collated D Head Nails</i> 73-74
BeA Strip Nailers	<i>Plastic Collated R20 Strip Nails</i> 75-77
BeA Staplers for RapidClip	<i>Staple type 14 / 16 / 155 and T Nails</i> 78-79
BeA Bar Code Tools	<i>Staple type 380</i> 80
BeA Cable Clip Nailers	<i>Cable Clips and Staple type 95</i> 80
BeA Plastic Washer Stapler	<i>Plastic Washers and Staple type G4450</i> 80
BeA Glazier Tools	<i>Brad type 300</i> 81
BeA Deco Nailers	<i>Deco Nail type ZN</i> 81
BeA Electric and Battery Screwdrivers	<i>Collated Screws</i> 82-83
BeA Battery and Pneumatic Screwdrivers + BeA Bits	<i>Loose Screws</i> 83
BeA Collated Drywall and Timber Screws	84-85
BeA BeFIX Screws and BeA XL (pallets and crates)	86-98
BeA BeFIX Screws	88-90
BeFIX Double Thread Screws and Anchor Screws and BeA Bits	91
BeA XL for Export and Professional Packaging	92-98
BeA expansion fastener BeCoFix	99-100
HVV Timber Connectors	101-102
BeA Hotmelt Technology	<i>Sticks 12 mm / 43 mm</i> 103-105
BeA Compressors and BeA Power Packages	106-107
BeA Autotec	108-117
BeA Compressed Air Accessories	118-119
General Terms and Conditions of Business	120-121
BeA Fasteners	123

BeA Cordless Tools

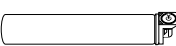
Item No.	Description	Fastener Type	Length from - to in mm	Capacity/Pieces	Weight (net)
 12100513	Cordless Tool D90-660 E with case	D Head Nails	50 - 90	67	3.7 kg
Item No.	Description	Pieces/Box	Pieces/Carton	Cartons/Pallet	kg/Carton
 10900508	Fuel Cell BeA 165 FC-RHP (40 g /80 ml)	12	72	40	4

Dynamik plastic container with 2.2 Mille D Head Nails + 2 Fuel Cells 40 g

Item No.	Description	Contents/Pack	Pack/Pallet	kg/Pack
10401288	D34 2.9 x 50 BK	2.2 Mille + 2 FC	84	6.6
10401286	D34 2.9 x 65 BK	2.2 Mille + 2 FC	84	8.3
10401275	D34 2.9 x 70 BK	2.2 Mille + 2 FC	84	8.9
10401287	D34 2.9 x 76 BK	2.2 Mille + 2 FC	72	9.6
10401298	D34 2.9 x 80 BK	2.2 Mille + 2 FC	72	10.8
10401276	D34 3.1 x 90 BK	2.2 Mille + 2 FC	72	12.1
10401277	D34 2.9 x 50 BK Ring	2.2 Mille + 2 FC	84	6.6
10401278	D34 2.9 x 65 BK Ring	2.2 Mille + 2 FC	84	8.3
10401279	D34 2.9 x 70 BK Ring	2.2 Mille + 2 FC	84	8.9
10401297	D34 2.9 x 76 BK Ring	2.2 Mille + 2 FC	72	9.6
10401285	D34 2.9 x 80 BK Ring	2.2 Mille + 2 FC	72	10.8
10401299	D34 3.1 x 83 BK Ring	2.2 Mille + 2 FC	72	11.3
10401296	D34 3.1 x 90 BK Ring	2.2 Mille + 2 FC	72	12.1
10401292	D34 2.9 x 70 NK	2.2 Mille + 2 FC	84	8.9
10401293	D34 3.1 x 90 NK	2.2 Mille + 2 FC	72	12.1
10401290	D34 2.9 x 50 NK Ring	2.2 Mille + 2 FC	84	6.6
10401294	D34 2.9 x 65 NK Ring	2.2 Mille + 2 FC	84	8.3
10401291	D34 2.9 x 70 NK Ring	2.2 Mille + 2 FC	84	8.9
10401280	D34 2.9 x 76 NK Ring	2.2 Mille + 2 FC	72	9.6
10401345	D34 3.1 x 83 NK Ring	2.2 Mille + 2 FC	72	11.3
10401309	D34 2.9 x 50 FV Ring	2.2 Mille + 2 FC	84	7.1
10401310	D34 2.9 x 65 FV Ring	2.2 Mille + 2 FC	84	8.8

All above mentioned D Head Nails have the required characteristics specified in Eurocode 5

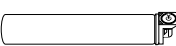

BeA Cordless Tools

Item No.	Description	Fastener Type	Length from - to in mm	Capacity/Pieces	Weight (net)
 12100512	Cordless Tool R60-664 E with case	R34 Anchor Nails	40 - 60	60	3.6 kg
Item No.	Description	Pieces/Box	Pieces/Carton	Cartons/Pallet	kg/Carton
 10900508	Fuel Cell BeA 165 FC-RHP (40g/80 ml)	12	72	40	4

R34 Anchor nails in Dynamik plastic container with 1 Fuel Cell 40 g

Item No.	Description	Contents/Pack	Pack/Pallet	kg/Pack
10401247	R34 4.0 x 40 NK Ring	1.25 Mille + 1 FC	84	5.6
10401248	R34 4.0 x 50 NK Ring	1.25 Mille + 1 FC	84	7.2
10401249	R34 4.0 x 60 NK Ring	1.25 Mille + 1 FC	72	8.3

All above mentioned Anchor Nails have the required characteristics specified in Eurocode 5
Further information on page 18

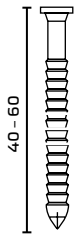

BeA Cordless Tools

Item No.	Description	Fastener Type	Length from - to in mm	Capacity/Pieces	Weight (net)	
	12000635	Cordless Wide Crown Stapler 246/100-670 E	246	75 - 100	110	5.0 kg

Item No.	Description	Pieces/Box	Pieces/Carton	Cartons/Pallet	kg/Carton	
	10900508	Fuel Cell BeA 165 FC-RHP (40 g / 80 ml)	12	72	40	3.0

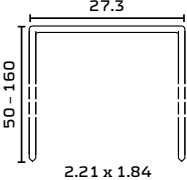
Item No.	Description	Mille/Carton	Cartons/Pallet	kg/Carton	
	10004384	246/75 A2 HZ	2.9	63	13.7
	10003885	246/90 A2 HZ	2.9	54	14.9
	10003890	246/100 A2 HZ	2.9	60	16.9

Staple type 246 in stainless steel has the required characteristics specified in Eurocode 5. Further information on page 18

Item No.	Description	Fastener Type	Length from - to in mm	Capacity/Pieces	Weight (net)	
	12100589	Cordless Metal Roofing Nailer R35-654 E with case	R20 Nails for Sheet Metal Clips	22 - 35	36	2.3 kg

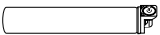
Item No.	Description	Pieces/Box	Pieces/Carton	Cartons/Pallet	kg/Carton	
	10900275	Fuel Cell 080 FCY (18 g / 30 ml)	12	72	40	3.0

Item No.	Description	Contents/Pack	Pack/Pallet	kg/Carton	
	10401821	R20 2.8 x 25 A2 Ring	2.2 Mille + 2 FC	84	2.8



BeA Cordless Tools

Item No.	Description	Fastener Type	Length from - to in mm	Capacity/Pieces	Weight (net)
 12100519	Cordless Tool SK350-651 E with case	SK 300	15 - 50	100	2.3 kg

Item No.	Description	Pieces/Box	Pieces/ Carton	Cartons/ Pallet	kg/ Carton
 10900275	Fuel Cell 080 FCY (18 g / 30 ml)	12	72	40	3.0

Item No.	Description	Mille/Box	Mille/ Carton	Cartons/ Pallet	kg/ Carton
10300643	SK 315 NK	5	100.0	60	13.8
10300644	SK 320 NK	5	60.0	60	10.9
10300645	SK 325 NK	5	60.0	60	13.7
10300646	SK 330 NK	5	60.0	60	16.1
10300717	SK 332 NK	5	60.0	48	17.9
10300649	SK 338 NK	5	50.0	51	16.7
10300650	SK 340 NK	5	50.0	51	17.8
10300651	SK 345 NK	5	40.0	40	16.1
10300652	SK 350 NK	5	40.0	40	17.8
10300337	SK 330 A4	5	60.0	60	17.6
10300338	SK 335 A4	5	50.0	51	16.5



Item No.	Description	Fastener Type	Length from - to in mm	Capacity/Pieces	Weight (net)
 12100520	Cordless Tool SK464-652 E with case	SK 400	25 - 64	100	2.2 kg

Item No.	Description	Pieces/Box	Pieces/ Carton	Cartons/ Pallet	kg/ Carton
 10900275	Fuel Cell 080 FCY (18 g / 30 ml)	12	72	40	3.0

Item No.	Description	Mille/Box	Mille/ Carton	Cartons/ Pallet	kg/ Carton
10300633	SK 425 NK	2	36.0	54	13.9
10300634	SK 432 NK	2	36.0	54	18.0
10300635	SK 435 NK	2	24.0	54	13.2
10300637	SK 445 NK	2	24.0	54	16.8
10300638	SK 450 NK	2	24.0	54	18.1
10300639	SK 455 NK	2	12.0	72	10.2
10300640	SK 457 NK	2	12.0	72	10.7
10300641	SK 460 NK	2	12.0	72	11.0
10300716	SK 464 NK	2	16.0	40	12.2

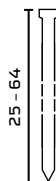

BeA Cordless Tools

Item No.	Description	Fastener Type	Length from - to in mm	Capacity/Pieces	Weight (net)
	12100518 Cordless Tool SKDA664-650 E with case	SKDA 600	25 - 64	100	2.3 kg

Item No.	Description	Pieces/Box	Pieces/Carton	Cartons/Pallet	kg/Carton
	10900275 Fuel Cell 080 FCY (18 g / 30 ml)	12	72	40	3.0

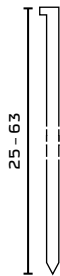

Item No.	Description	Mille/Box	Mille/Carton	Cartons/Pallet	kg/Carton
10300397	SKDA 632 NK HZ	4	16.0	56	11.7
10300398	SKDA 638 NK HZ	4	16.0	56	13.3
10300399	SKDA 644 NK HZ	4	16.0	56	15.4
10300400	SKDA 650 NK HZ	4	16.0	56	17.9
10300401	SKDA 656 NK HZ	4	16.0	56	21.0
10300402	SKDA 663 NK HZ	4	16.0	56	21.8
10300405	SKDA 638 A2 HZ	4	16.0	56	13.3
10300407	SKDA 650 A2 HZ	4	16.0	56	17.9
10300409	SKDA 663 A2 HZ	4	16.0	56	21.8

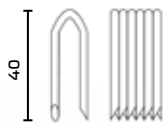

Item No.	Description	Fastener Type	Length from - to in mm	Capacity/Pieces	Weight (net)
	12100682 Cordless fencing nailer WZK 40/40-667E with case	Fencing staples 31/40 FV HZ	40	75	3.8 kg



Item No.	Description	Mille/Pack	Pack/Pallet	kg/Pack
10005538	31/40 FV HZ	2.2 + 2 FC	128	9.0



BeA Cordless Concrete Tools

Item No.	Description	Fastener Type	Length from - to in mm	Capacity/Pieces	Weight (net)
 12100517	Cordless Tool CN 40-668 E with case	Concrete Nails Type CN	15 - 40	40	3.7 kg
 12000507	Cordless concrete nailer CN 60-688 ES with case	Concrete Nails Type CN	15 - 58	40	3.7 kg
Item No.	Description	Pieces/Box	Pieces/Carton	Cartons/Pallet	kg/Carton
 10900508	Fuel Cell BeA 165 FC-RHP (40 g /80 ml)	12	72	32	8

BeA Pack 1 Mille Steel nails = 1 Fuel Cell

Item No.	Description	Content/Pack	Packs/Carton	Cartons/Pallet	kg/Carton
10400614	CN 26 x 15 P1000	1 Mille + 1 FC	10.0	18	12.8
10400615	CN 26 x 20 P1000	1 Mille + 1 FC	10.0	18	13.2
10400616	CN 26 x 25 P1000	1 Mille + 1 FC	10.0	18	15.2
10400617	CN 26 x 30 P1000	1 Mille + 1 FC	10.0	18	17.0
10400618	CN 26 x 35 P1000	1 Mille + 1 FC	10.0	18	20.0
10400619	CN 26 x 40 P1000	1 Mille + 1 FC	10.0	18	21.4

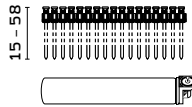

Contents: 1 Mille Steel Nails and one Fuel Cell BeA 152 FC-R for Dynamik CN60-688ES. also fit into e.g. Spit Pulsa 1000 and Powers Trak it. Würth DIGA CS1





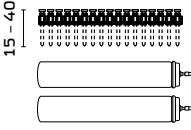

BeA Cordless Concrete Tools

	Item No.	Description	Pieces/ Box	Pieces/ Carton	Cartons/ Pallet	kg/ Carton
	10900277	Fuel Cell 115 FC (25 g / 45 ml)	12	72	40	8

BeA Pack 1 Mille Steel nails and 2 Fuel Cells

	Item No.	Description	Content/Pack	Packs/ Carton	Cartons/ Pallet	kg/ Carton
	10400620	CN 26 x 15 P 700	1 Mille + 2 FC	10.0	18	12.8
	10400621	CN 26 x 20 P 700	1 Mille + 2 FC	10.0	18	13.2
	10400622	CN 26 x 25 P 700	1 Mille + 2 FC	10.0	18	15.2
	10400623	CN 26 x 30 P 700	1 Mille + 2 FC	10.0	18	17.0
	10400624	CN 26 x 35 P 700	1 Mille + 2 FC	10.0	18	20.0
	10400625	CN 26 x 40 P 700	1 Mille + 2 FC	10.0	18	21.4

Content: 1 Mille steel nails and 2 fuel cells BeA155 FC also fit into e.g. Spit Pulsa 700

	Item No.	Description
	14408294	Power supply and charger
	14509849	Battery 6 Volt
	14407629	Oil 100 ml
	14407630	Cleaner 500 ml



Sturdy stackable
plastic case



BeA Staplers for Fine Wire Staples

	Item No.	Description	Fastener Type	Length from - to in mm	Capacity/Pieces	Weight (net)
	12000063	380/16-420	80 / 380	6 - 16	157	1.0 kg
	12000075	380/14-450 A Automatic	80 / 380	6 - 14	161	1.2 kg
	12000076	380/14-450 AL Automatic Long magazine	80 / 380	6 - 16	312	1.3 kg
	12000024	380/16-400 Flare	80 / 380	6 - 16	160	1.0 kg
	12000073	380/16-429 LN with 50 mm nose	80 / 380	6 - 16	161	1.4 kg



BeA Staplers for Fine Wire Staples

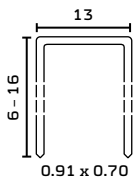

Item No.	Description	Mille/ Box	Mille/ Carton	Cartons/ Pallet	kg/ Carton
10000731	380/06 NK	24	192.0	48	18.2
10000736	380/08 NK	21	168.0	48	19.0
10000741	380/10 NK	18	144.0	48	18.4
10000750	380/12 NK	15	120.0	48	17.6
10000754	380/14 NK	15	120.0	40	20.0
10000734	380/06 NKS	24	192.0	48	18.2
10000739	380/08 NKS	21	168.0	48	19.0
10000747	380/10 NKS	18	144.0	48	18.4
10000753	380/12 NKS	15	120.0	48	17.6
10000757	380/14 NKS	15	120.0	40	20.0
10000758	380/16 NKS	12	96.0	48	18.1
10003296	80/06 A4	25	200.0	40	19.0
10003288	80/08 A4	22.5	180.0	40	20.3
10003287	80/10 A4	20	160.0	40	20.5
10003297	80/12 A4	15	120.0	40	17.6
10003298	80/14 A4	15	120.0	40	20.0
10000732	380/06 NK black	24	192.0	48	18.2
10000737	380/08 NK black	21	168.0	48	19.0
10000745	380/10 NK black	18	144.0	48	18.4
10000751	380/12 NK black	15	120.0	48	17.6
10000755	380/14 NK black	15	120.0	40	20.0
10000203	80/06 NK DP	5	200.0	40	19.0
10000216	80/08 NK DP	5	160.0	40	18.9
10003294	80/06 LM	25	200.0	40	7.0
10003286	80/08 LM	22.5	180.0	40	7.4
10003285	80/10 LM	20	160.0	40	7.4
10003284	80/12 LM	15	120.0	40	6.9



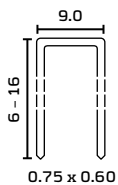

BeA Staplers for Fine Wire Staples

	Item No.	Description	Fastener Type	Length from - to in mm	Capacity/Pieces	Weight (net)
	12000330	71/16-421 with 25 mm Nose	71	6 - 16	190	1.0 kg
	12000077	71/14-451 A Automatic Long magazine on request	71	6 - 14	194	1.2 kg
	12000324	71/16-421 Profil	71	6 - 16	190	1.1 kg
	12000074	71/16-436 LN Long nose	71	6 - 16	190	1.0 kg
	12000058	71/16-416 LN Long nose	71	6 - 16	190	1.1 kg



Item No.	Description	Mille/Box	Mille/Carton	Cartons/Pallet	kg/Carton
10000093	71/04 NK	20	480.0	40	21.6
10000095	71/05 NK	20	480.0	40	23.0
10000099	71/06 NK	20	360.0	40	20.9
10004564	71/08 NK	20	240.0	55	15.4
10000112	71/10 NK	20	240.0	50	18.5
10000125	71/12 NK	20	240.0	44	23.0
10001777	71/14 NK	20	160.0	55	16.5
10004239	71/16 NKS	12	168.0	40	20.2
10000131	71/12 NK black	20	200.0	40	19.2

BeA Staplers for Fine Wire Staples

	Item No.	Description	Fastener Type	Length from - to in mm	Capacity/Pieces	Weight (net)
	12000069	72/16-422	72	6 - 16	190	1.0 kg
	12000079	72/14-452 A Automatic	72	6 - 14	194	1.2 kg

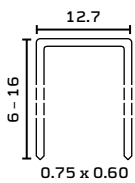

Item No.	Description	Mille/Box	Mille/Carton	Cartons/Pallet	kg/Carton
10000150	72/06 NKS	32.8	262.1	40	18.6
10000154	72/08 NKS	25.5	203.8	40	16.3
10000158	72/10 NKS	21.8	174.7	40	15.2
10000164	72/12 NKS	18.2	145.6	40	15.7
10000166	72/14 NKS	14.6	116.5	40	13.6

	Item No.	Description	Fastener Type	Length from - to in mm	Capacity/Pieces	Weight (net)
	12000071	95/16-425	95	6 - 16	114	1.0 kg

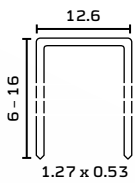

Item No.	Description	Mille/Box	Mille/Carton	Cartons/Pallet	kg/Carton
10001731	95/06 NK	5	140.0	40	15.8
10000433	95/08 NK	5	100.0	40	13.3
10000437	95/10 NK	5	100.0	40	15.3
10000439	95/12 NK	5	80.0	40	13.8
10000441	95/14 NK	5	80.0	40	15.4
10000444	95/16 NK	5	60.0	40	12.8



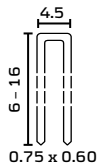

BeA Staplers for Fine Wire Staples

Item No.	Description	Fastener Type	Length from - to in mm	Capacity/Pieces	Weight (net)	
	12000042	74/16-404	74	6 - 16	190	1.0 kg



Item No.	Description	Mille/Box	Mille/Carton	Cartons/Pallet	kg/Carton
10000171	74/08 NK	10	300.0	68	16.2
10000174	74/10 NK	10	200.0	68	13.0
10000175	74/12 NK	10	200.0	68	16.6
10000178	74/14 NK	10	200.0	51	18.8
10000182	74/16 NK	10	130.0	68	15.3

Item No.	Description	Fastener Type	Length from - to in mm	Capacity/Pieces	Weight (net)	
	12000156	97/25-550	97	10 - 25	156	1.2 kg
	12000048	97/16-407	97	6 - 16	100	1.0 kg

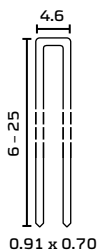

Item No.	Description	Mille/Box	Mille/Carton	Cartons/Pallet	kg/Carton
10000451	97/06 NK HZ	5.0	275.0	68	15.7
10000457	97/08 NK HZ	15.6	187.2	68	14.6
10001927	97/10 NK HZ	19.5	234.0	52	21.8
10001928	97/12 NK HZ	31.2	187.2	52	21.9
10001929	97/14 NK HZ	27.3	163.8	52	21.1
10001930	97/16 NK HZ	23.4	140.4	52	20.2
10001910	97/19 NK HZ	19.5	117.0	52	19.9
10001931	97/22 NK HZ	15.6	93.6	52	18.4
10001932	97/25 NK HZ	15.6	93.6	52	20.9
10000513	97/22 NR A4	7.8	70.2	65	13.8

BeA Staplers for Fine Wire Staples

Item No.	Description	Fastener Type	Length from - to in mm	Capacity/Pieces	Weight (net)
12000157	98/25-551	98	10 - 25	168	1.2 kg

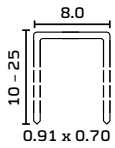

Item No.	Description	Mille/Box	Mille/Carton	Cartons/Pallet	kg/Carton
10001936	98/12 NK HZ	19.2	115.2	52	15.0
10001937	98/14 NK HZ	16.8	100.8	52	14.0
10001938	98/16 NK HZ	14.4	86.4	52	14.0
10001939	98/19 NK HZ	12.0	72.0	52	14.0
10001940	98/22 NK HZ	9.6	57.6	52	13.0
10001941	98/25 NK HZ	9.6	57.6	52	14.0

BeA Staplers for Medium Wire Staples

Item No.	Description	Fastener Type	Length from - to in mm	Capacity/Pieces	Weight (net)
12000158	90/25-552	90	9 - 25	120	1.2 kg
12000199	90/32-611 C Contact Actuation Long magazine on request	90	15 - 32	125	1.3 kg
12000230	90/40-621 C Contact Actuation	90	15 - 40	125	1.4 kg
12000234	90/40-711 C Contact Actuation	90	15 - 40	125	1.9 kg



BeA Staplers for Medium Wire Staples

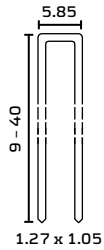

Item No.	Description	Mille/Box	Mille/Carton	Cartons/Pallet	kg/Carton
10004105	90/09 NK HZ	9.8	117.6	68	19.5
10002642	90/12 NK HZ	7.0	70.0	60	15.8
10002643	90/15 NK HZ	6.0	60.0	60	16.8
10002644	90/18 NK HZ	5.0	50.0	60	16.7
10002946	90/21 NK HZ	4.0	40.0	64	15.3
10002646	90/25 NK HZ	3.0	45.0	48	20.5
10002648	90/30 NK HZ	3.0	30.0	60	16.4
10002649	90/32 NK HZ	3.0	30.0	60	17.1
10002650	90/35 NK HZ	2.0	30.0	48	18.9
10002651	90/38 NK HZ	2.0	30.0	48	20.8
10002652	90/40 NK HZ	2.0	20.0	64	14.5
10000309	90/25 NR A4	4.2	37.8	51	17.2
10000330	90/35 NR A4	2.8	33.6	51	21.2

Item No.	Description	Fastener Type	Length from - to in mm	Capacity/Pieces	Weight [net]
	12000159 92/25-553	92	9 - 25	120	1.2 kg
	12000450 92/25-553 Flare	92	9 - 25	120	1.4 kg
	12000437 92/32-632 C Contact Actuation	92	15 - 32	125	1.4 kg
	14400902 Adjustable roller guide				
	12000214 92/32-612 AL Automatic long magazine	92	15 - 32	215	1.9 kg
	12000343 92/40-722 C Contact Actuation	92	15 - 40	211	2.1 kg
	14400891 Height adjustable stop				

BeA Staplers for Medium Wire Staples

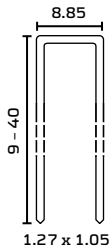

Item No.	Description	Mille/ Box	Mille/ Carton	Cartons/ Pallet	kg/ Carton
10000343	92/09 NK HZ	5.0	50.0	85	9.9
10002653	92/12 NK HZ	8.4	50.4	72	13.0
10002654	92/15 NK HZ	7.2	43.2	72	13.1
10002655	92/18 NK HZ	6.0	36.0	72	12.8
10002937	92/21 NK HZ	4.8	28.8	80	11.9
10002657	92/25 NK HZ	3.6	21.6	96	10.4
10002943	92/28 NK HZ	3.6	21.6	80	11.7
10002936	92/30 NK HZ*	3.6	21.6	80	12.3
10002660	92/32 NK HZ*	3.6	21.6	72	13.2
10002661	92/35 NK HZ*	2.4	21.6	72	14.2
10002662	92/38 NK HZ*	2.4	14.4	96	10.2
10002663	92/40 NK HZ*	2.4	14.4	80	10.9

* Conforms to DIN 18182 Part 2 band EN 14566



Item No.	Description	Fastener Type	Length from - to in mm	Capacity/ Pieces	Weight (net)
12000220	94/32-614 C Contact Actuation Automatic on request	94	15 - 32	125	1.6 kg

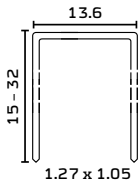

Item No.	Description	Mille/ Box	Mille/ Carton	Cartons/ Pallet	kg/ Carton
10000414	94/15 NK HZ	5.0	60.0	40	22.0
10000418	94/18 NK HZ	5.0	50.0	40	21.0
10000420	94/21 NK HZ	5.0	40.0	40	19.0
10000423	94/25 NK HZ	5.0	40.0	40	22.0
10000425	94/30 NK HZ	3.0	24.0	40	15.5
10000427	94/32 NK HZ	3.0	24.0	40	16.5
10002947	94/25 NR A4	5.0	40.0	40	22.0



BeA Staplers for Heavy Wire Staples

Item No.	Description	Fastener Type	Length from - to in mm	Capacity/Pieces	Weight (net)
 12000215	14/32-613 C Contact Actuation Long magazine on request	14 16 155	15 - 32	Type 14 - 110 Type 16 - 102 Type 155 - 102	1.4 kg
14400847	Roller edge guide				
 12000533	14/40-770 C Contact Actuation	14 16 155	18 - 40	Type 14 - 110 Type 16 - 152 Type 155 - 152	1.9 kg
 12000257	14/50-763 C Contact Actuation also available with single actuation	14 16 155	25 - 50	Type 14 - 110 Type 16 - 144 Type 155 - 144	2.7 kg
 12000260	14/50-764 C Contact Actuation	14 16 155	25 - 50	Type 14 - 110 Type 16 - 144 Type 155 - 144	2.6 kg
 12000522	14/50-780 C Contact Actuation	14 16 155	32 - 50	Type 14 - 110 Type 16 - 152 Type 155 - 152	2.3 kg
 12000649	14/50-785 A Automatic	14 16 155	32 - 50	Type 14 - 110 Type 16 - 152 Type 155 - 152	2.3 kg
 12000506	14/65-830 C Contact Actuation	14 16 155	40 - 65	Type 14 - 110 Type 16 - 152 Type 155 - 152	2.7 kg
 12000651	14/65-830 A	14 16 155	40 - 65	Type 14 - 110 Type 16 - 152 Type 155 - 152	2.7 kg

BeA Staplers for Heavy Wire Staples

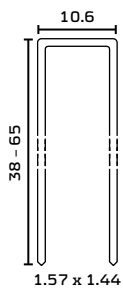
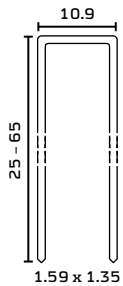
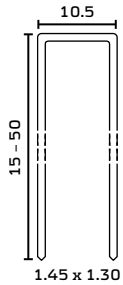



Item No.	Description	Mille/ Carton	Cartons/ Pallet	kg/ Carton
10000005	14/15 NK HZ	39.0	54	16.2
10000013	14/18 NK HZ	31.2	54	15.9
10000019	14/21 NK HZ	27.3	54	15.7
10000024	14/25 NK HZ	23.4	54	15.3
10000031	14/28 NK HZ	23.4	54	17.4
10000033	14/30 NK HZ	23.4	54	18.5
10003384	14/32 NK HZ	10.0	116	8.5
10004811	14/35 NK HZ*	10.0	96	9.2
10003385	14/38 NK HZ*	10.0	96	10.0
10004787	14/40 NK HZ*	10.0	84	10.3
10003386	14/45 NK HZ	10.0	75	11.5
10003387	14/50 NK HZ	10.0	75	12.9
10000029	14/25 NR HZ A4 DP	12.0	119	7.9
10003748	16/25 NK HZ	20.2	54	15.8
10003690	16/30 NK HZ	20.2	54	19.7
10004789	16/32 NK HZ	10.0	88	10.4
10004804	16/35 NK HZ	10.0	88	10.9
10002618	16/38 NK HZ*	10.0	88	11.8
10003352	16/40 NK HZ*	10.0	88	12.4
10002619	16/45 NK HZ*	10.0	80	13.6
10002620	16/50 NK HZ*	10.0	60	15.1
10003751	16/60 NK HZ*	10.0	54	18.7
10003693	16/65 NK HZ*	10.0	45	20.2
10003268	16/32 NK HZ	16.8	54	17.4
10003270	16/38 NK HZ	10.0	88	11.8
10003272	16/45 NK HZ	10.0	80	13.6
10003274	16/50 NK HZ	10.0	60	15.1
10000604	155/21 NK HZ CD	13.0	68	9.2
10000629	155/45 NR HZ A4	9.0	85	12.2
10002051	155/50 NR HZ A4	7.0	85	11.0
10004890	155/45 VZ HZ	10.0	80	13.6
10004838	155/50 VZ HZ	10.0	60	15.1
10002719	155/56 VZ HZ	10.9	54	20.2
10002177	155/65 VZ HZ	10.9	45	22.5

* Conforms to DIN 18182 Part 2 and EN 14566

Staple type 155 in heavy galvanized and stainless steel (A4) are certified to DIN 1052 and have the required characteristics specified in Eurocode 5. Further information on page 18



BeA Staplers for Heavy Wire Staples

Item No.	Description	Fastener Type	Length from - to in mm	Capacity/Pieces	Weight (net)
	12000500 180/65-835 C Contact Actuation	180	40 - 65	132	2.7 kg
	12000650 180/65-835 A Automatic	180	40 - 65	132	2.7 kg
	12000541 180/90-839 C Contact Actuation	180	40 - 90	132	3.1 kg

Item No.	Description	Mille/ Carton	Cartons/ Pallet	kg/ Carton
10004812	180/40 NK HZ	10.0	65	16.6
10004800	180/45 NK HZ	10.0	63	18.3
10004836	180/50 NK HZ	5.0	84	10.6
10004864	180/55 NK HZ	5.0	78	11.2
10004865	180/60 NK HZ	5.0	78	12.1
10004801	180/63 NK HZ	5.0	78	12.7
10004813	180/65 NK HZ	5.0	78	13.1
10002076	180/70 NK HZ	3.8	102	11.6
10001810	180/80 NK HZ	3.2	102	10.5
10003482	180/90 NK HZ	3.8	68	13.2
10004835	180/45 VZ HZ	10.0	63	18.3
10004837	180/50 VZ HZ	5.0	84	10.6
10002720	180/56 VZ HZ	8.6	54	20.7
10004839	180/63 VZ HZ	5.0	78	12.7
10000697	180/65 VZ HZ	4.0	102	10.5
10000676	180/50 NR HZ A4	5.0	102	10.6
10000692	180/63 NR HZ A4	4.0	102	10.2



Staple type 180 in heavy and stainless steel (A4) are certified to DIN 1052 and have the required characteristics specified in Eurocode 5. Further information on page 18



BeA Staplers for Heavy Wire Staples

Item No.	Description	Fastener Type	Length from - to in mm	Capacity/Pieces	Weight (net)
12000544	200/90-838 C Contact Actuation	200	40 - 90	112	3.1 kg

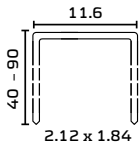

Item No.	Description	Mille/ Carton	Cartons/ Pallet	kg/ Carton
10005067	200/63 VZ HZ	3.2	85	11.8
10005035	200/80 VZ HZ	2.1	119	7.6
10005036	200/90 VZ HZ	2.1	85	10.8

BeA Skater for Heavy Wire Staples

Item No.	Description	Fastener Type	Length from - to in mm	Capacity/Pieces	Weight (net)
14412430	Skater 14/65-830 C	14	40 - 65	Type 14 - 110	11.8 kg
12000624		16		Type 16 - 152	
		155		Type 155 - 152	

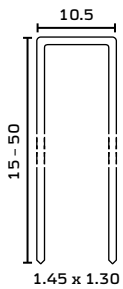

Item No.	Description	Mille/ Carton	Cartons/ Pallet	kg/ Carton
10004787	14/40 NK HZ*	10.0	84	10.3
10003386	14/45 NK HZ	10.0	75	11.5
10003387	14/50 NK HZ	10.0	75	12.9
10003352	16/40 NK HZ*	10.0	88	12.4
10002619	16/45 NK HZ*	10.0	80	13.6
10002620	16/50 NK HZ*	10.0	60	15.1
10003751	16/60 NK HZ*	10.0	54	18.7
10003693	16/65 NK HZ*	10.0	45	20.2
10003272	16/45 NK HZ	10.0	80	13.6
10003274	16/50 NK HZ	10.0	60	15.1
10000629	155/45 NR HZ A4	9.0	85	12.2
10002051	155/50 NR HZ A4	7.0	85	11.0
10004890	155/45 VZ HZ	10.0	80	13.6
10004838	155/50 VZ HZ	10.0	60	15.1
10002719	155/56 VZ HZ	10.9	54	20.2
10002177	155/65 VZ HZ	10.9	45	22.5



* Conforms to DIN 18182 Part 2 and EN 14566

Staple type 155 in heavy galvanized and stainless steel (A4) are certified to DIN 1052 and have the required characteristics specified in Eurocode 5. Further information on page 18



BeA Skater for Heavy Wire Staples

Item No.	Description	Fastener Type	Length from - to in mm	Capacity/Pieces	Weight (net)
14412430 12000625	Skater 180/65-835 C	180	40 - 65	132	11.8 kg







Item No.	Description	Mille/ Carton	Cartons/ Pallet	kg/ Carton
10004812	180/40 NK HZ	10.0	65	16.6
10004800	180/45 NK HZ	10.0	63	18.3
10004836	180/50 NK HZ	5.0	84	10.6
10004864	180/55 NK HZ	5.0	78	11.2
10004865	180/60 NK HZ	5.0	78	12.1
10004801	180/63 NK HZ	5.0	78	12.7
10004813	180/65 NK HZ	5.0	78	13.1
10004835	180/45 VZ HZ	10.0	63	18.3
10004837	180/50 VZ HZ	5.0	84	10.6
10002720	180/56 VZ HZ	8.6	54	20.7
10004839	180/63 VZ HZ	5.0	78	12.7
10004697	180/65 VZ HZ	4.0	102	10.5
10000676	180/50 NR HZ A4	5.0	102	10.6
10000692	180/63 NR HZ A4	4.0	102	10.2

Staple type 180 in heavy and stainless steel (A4) are certified to DIN 1052 and have the required characteristics specified in Eurocode 5. Further information on page 18

Item No.	Accessories for Skater 14/65-830 C and Skater 180/65-835 C
14412428	Edge guide
14412429	Extension handle
14406482	Rail 3.0 m (connected with edge guide)
14409063	Rail 3.5 m (connected with edge guide)
14412767	Rail guide set



BeA Staplers for Wide Crown Staples

Item No.	Description	Fastener Type	Length from - to in mm	Capacity/Pieces	Weight (net)	
	12000180	42/38-159 C Contact Actuation	42	16 - 38	148	2.8 kg
	Item No.	Description		Mille/ Carton	Cartons/ Pallet	kg/ Carton
	10002724	42/16 NK		16.4	68	12.6
	10002725	42/19 NK		13.3	68	11.4
	10002726	42/22 NK		11.5	68	10.9
	10002727	42/25 NK		10.7	68	11.0
	10002729	42/30 NK		8.9	68	10.4
	10002730	42/35 NK		7.1	68	9.4
10002632	42/38 NK		7.1	68	9.9	
	12200061	146/80-159 C Contact Actuation	146	50 - 80	150	3.0 kg
	Item No.	Description		Mille/ Carton	Cartons/ Pallet	kg/ Carton
	10003383	146/50 NK HZ		3.0	102	7.5
	10002349	146/75 VZ HZ		2.0	102	6.0
	10003809	146/75 NR HZ		2.0	102	6.0
 	12000177	140/38-153 C Contact Actuation	140	14 - 38	200	2.8 kg
	12000194	145/32-178	140	12 - 32	165	2.3 kg

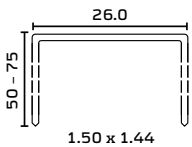
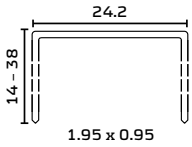

BeA Staplers for Wide Crown Staples

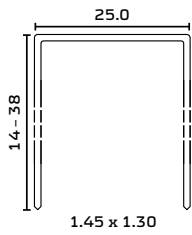

Item No.	Description	Mille/ Carton	Cartons/ Pallet	kg/ Carton
10001796	140/14 NK HZ	20.0	68	11.7
10001797	140/16 NK HZ	18.0	68	11.5
10001798	140/19 NK HZ	14.0	68	9.9
10001799	140/22 NK HZ	12.0	68	9.4
10001800	140/25 NK HZ	12.0	68	10.3
10001801	140/30 NK HZ	10.0	68	9.8
10001802	140/35 NK HZ	8.0	68	8.8
10001803	140/38 NK HZ	8.0	68	9.3



Item No.	Description	Fastener Type	Length from - to in mm	Capacity/ Pieces	Weight [net]
12000463	246/110-851 E Single Actuation	246	50 - 110	120	5.0 kg
12100471	246/130-944 E Single Actuation	246	65 - 130	120	5.4 kg
12100476	246/160-964 E Single Actuation	246	65 - 160	125	6.3 kg
14001138	Pressure reduction valve 6 bar R 1/4				

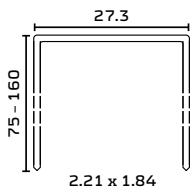

Item No.	Description	Mille/ Carton	Cartons/ Pallet	kg/ Carton
10004384	246/75 NR HZ A2*	2.9	63	13.7
10003885	246/90 NR HZ A2*	2.9	54	14.9
10003890	246/100 NR HZ A2*	2.9	60	16.9
10004523	246/105 NR HZ A2*	2.9	45	19.8
10003891	246/110 NR HZ A2*	2.9	45	19.2
10003892	246/120 NR HZ A2*	1.4	90	10.3
10003893	246/130 NR HZ A2*	1.4	96	11.0
10001917	246/150 NR HZ A2	1.4	63	12.4

* Staple type 180 246 in stainless steel have the required characteristics specified in Eurocode 5.
Further information on page 18

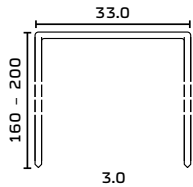

BeA Staplers for Wide Crown Staples

Item No.	Description	Fastener Type	Length from - to in mm	Capacity/Pieces	Weight (net)
	12000548 346/200-951 E Single Actuation	346	200	70	10.5 kg



Item No.	Description	Mille/ Carton	Cartons/ Pallet	kg/ Carton
10005438	346/160 NR A2	0.6	54	11.0
10005034	346/200 NR A2	0.7	45	17.5

BeA Staplers for EPAL Staples



Item No.	Description	Fastener Type	Length from - to in mm	Capacity/Pieces	Weight (net)
	12000349 Stapler 33/13-177 for EPAL Staples	33	13 mm	82	2.4 kg
	12300970 Autotec Tool 33/13 L5E for EPAL Staples	33	13 mm	280	4.0 kg



BeA is a partner of the European Pallet Association (EPAL). In this function BeA produces all embossed staples for the EPAL Association. These staples are only available directly from the EPAL Association.



BeA Variant Tools

Item No.	Description	Fastener Type	Length from - to in mm	Capacity/Pieces	Weight (net)
	12000174	14 16 155 T-Nails	Staples 15 - 40 Nails 25 - 38	Staples 100 T-Nails 66	2.5 kg
	14400891	Height adjustable stop e.g. for fibre cement board			
	12000271	14 16 155 T-Nails	Staples 25 - 65 Nails 25 - 62	Staples 144 T-Nails 100	3.3 kg
	14404669	Tool balance			
	14405328	Attachment for parquet flooring			

Item No.	Description	Mille/Box	Mille/Carton	Cartons/Pallet	kg/ Carton
10000005	14/15 NK HZ	-	39.0	54	16.2
10000013	14/18 NK HZ	-	31.2	54	15.9
10000019	14/21 NK HZ	-	27.3	54	15.7
10000024	14/25 NK HZ	-	23.4	54	15.3
10000031	14/28 NK HZ	-	23.4	54	17.4
10000033	14/30 NK HZ	-	23.4	54	18.5
10003384	14/32 NK HZ	-	10.0	116	8.5
10004811	14/35 NK HZ*	-	10.0	96	9.2
10003385	14/38 NK HZ*	-	10.0	96	10.0
10004787	14/40 NK HZ*	-	10.0	84	10.3
10003386	14/45 NK HZ	-	10.0	75	11.5
10003387	14/50 NK HZ	-	10.0	75	12.9
10000029	14/25 NR HZ A4 DP	-	12.0	119	7.9
10003748	16/25 NK HZ	-	20.2	15.8	54
10003690	16/30 NK HZ	-	20.2	19.7	54
10004789	16/32 NK HZ	-	10.0	10.4	88
10004804	16/35 NK HZ	-	10.0	10.9	88
10002618	16/38 NK HZ*	-	10.0	11.8	88
10003352	16/40 NK HZ*	-	10.0	12.4	88
10002619	16/45 NK HZ*	-	10.0	13.6	80
10002620	16/50 NK HZ*	-	10.0	15.1	60
10003751	16/60 NK HZ*	-	10.0	18.7	54
10003693	16/65 NK HZ*	-	10.0	20.2	45
10003268	16/32 NK HZ	-	16.8	17.4	54

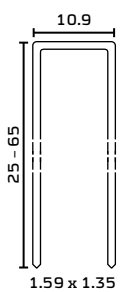

* Conforms to DIN 18182 Part 2 and EN 14566
 Staple type 155 in heavy galvanized and stainless steel (A4) are certified to DIN 1052 and have the required characteristics specified in Eurocode 5

BeA Variant Tools

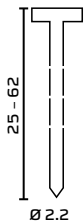
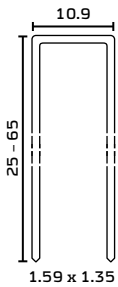

Item No.	Description	Mille/Box	Mille/ Carton	Cartons/ Pallet	kg/ Carton
10003281	16/35 NK HZ Flare	-	16.8	18.3	54
10003270	16/38 NK HZ Flare	-	10.0	11.8	88
10003272	16/45 NK HZ Flare	-	10.0	13.6	80
10003274	16/50 NK HZ Flare	-	10.0	15.1	60
10000604	155/21 NK HZ CD	-	13.0	9.2	68
10000629	155/45 NR HZ A4	-	9.0	12.2	85
10002051	155/50 NR HZ A4	-	7.0	11.1	85
10004890	155/45 VZ HZ	-	10.0	13.6	80
10004838	155/50 VZ HZ	-	10.0	15.1	60
10002719	155/56 VZ HZ	-	10.9	54	20.2
10002177	155/65 VZ HZ	-	10.9	45	22.5
10200259	T 25 NKS	1.0	20.0	17.1	45
10200260	T 32 NKS	1.0	10.0	10.1	54
10200241	T 25 NK	2.0	20.0	17.1	45
10200248	T 32 NK	2.0	20.0	21.0	60
10200247	T 38 NK	1.0	10.0	12.9	54
10200246	T 44 NK	1.0	10.0	15.0	54
10200242	T 50 NK	1.0	10.0	16.5	54
10200245	T 54 NK	1.0	10.0	17.3	45
10200244	T 62 NK	1.0	10.0	20.1	36

* Conforms to DIN 18182 Part 2 and EN 14566

Staple type 155 in heavy galvanized and stainless steel (A4) are certified to DIN 1052 and have the required characteristics specified in Eurocode 5





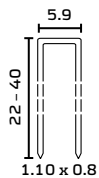

Item No.	Description	Fastener Type	Length from - to in mm	Capacity/ Pieces	Weight (net)
12100347	Variant Tools 229 C Contact Actuation	99 SK 300	Staples: 22 - 40 Brads: 20 - 50	Staples: 100 Brads: 80	1.4 kg



Item No.	Description	Mille/Box	Mille/ Carton	Cartons/ Pallet	kg/ Carton
10000568	99/25 NK HZ	4.0	40.0	68	14.9
10000569	99/30 NK HZ	4.0	40.0	68	17.4
10000571	99/40 NKS HZ	3.2	25.6	68	14.3
10300644	SK 320 NK	5.0	60.0	60	10.9
10300645	SK 325 NK	5.0	60.0	60	13.7
10300646	SK 330 NK	5.0	60.0	60	16.1
10300717	SK 332 NK	5.0	60.0	48	17.9
10300648	SK 335 NK	5.0	50.0	51	16.0
10300649	SK 338 NK	5.0	50.0	51	16.7
10300650	SK 340 NK	5.0	50.0	51	17.8
10300651	SK 345 NK	5.0	40.0	40	16.1
10300652	SK 350 NK	5.0	40.0	40	17.8

BeA Staplers for Carton Closing Staples

	Item No.	Description	Fastener Type	Length from - to in mm	Capacity/Pieces	Weight (net)
	12100278	MT A18 Manual	Packfix	16 + 19	100	2.1 kg
	12100281	MT A22 Manual	Packfix	19 + 22	100	2.1 kg
	12100282	AT A18 Air	Packfix	16 + 19	100	2.5 kg
	12100283	AT A22 Air	Packfix	19 + 22	100	2.5 kg

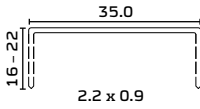
	Item No.	Description	Mille/Box	Mille/Carton	Cartons/Pallet	kg/Carton
	10002763	Packfix 5/8 VK [35/15]	2	20.0	36	18.7
	10002764	Packfix 3/4 VK [35/18]	2	20.0	36	19.5
	10002765	Packfix 7/8 VK [35/22]	2	16.0	32	21.0

	Item No.	Description	Fastener Type	Length from - to in mm	Capacity/Pieces	Weight (net)
	12100287	CT IC 1823 Coil Air	Packfix-coil GR I	16 + 19	1 Coil	2.5 kg

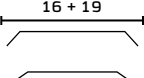
	Item No.	Description	Mille/Carton	Cartons/Pallet	kg/Carton
	10002775	Packfixcoil GR I, 5/8 VK	24.0	48	20.3
	10002776	Packfixcoil GR I, 3/4 VK	24.0	48	22.8



BeA Stapler for Plastic Staples

Item No.	Description	Fastener Type	Length from - to in mm	Capacity/Pieces	Weight (net)	
	12000358	P8/16-428 for plastic staples Also available with safety yoke	P8	10 - 15	76	1.0 kg

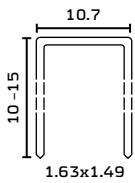

Item No.	Description	Mille/Box	Mille/Carton	Cartons/Pallet	kg/Carton
10002611	Plastic staple P8/10	10.1	201.6	9	16.6
10004563	Plastic staple P8/15	8.0	159.6	24	18.0

BeA Pneumatic Clipping Tool

Item No.	Description	Fastener Type	Length from - to in mm	Capacity/Pieces	Weight (net)	
	12000060	95/16-418 Long magazine on request	95	6 - 16	114	1.4 kg

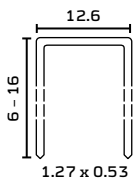

Item No.	Description	Mille/Box	Mille/Carton	Cartons/Pallet	kg/Carton
10001731	95/06 NK	5	140.0	40	15.8
10000433	95/08 NK	5	100.0	40	13.3
10000437	95/10 NK	5	100.0	40	15.3
10000439	95/12 NK	5	80.0	40	13.8
10000441	95/14 NK	5	80.0	40	15.4
10000444	95/16 NK	5	60.0	40	12.8

BeA Pneumatic Clipping Tool



Item No.	Description	Fastener Type	Length from - to in mm	Capacity/Pieces	Weight (net)
12000062	380/16-419	80/380	6 - 16	160	1.4 kg

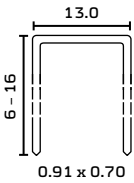

Item No.	Description	Mille/Box	Mille/Carton	Cartons/Pallet	kg/Carton
10000731	380/06 NK	24	192.0	48	18.2
10000736	380/08 NK	21	168.0	48	19.0
10000741	380/10 NK	18	144.0	48	18.4
10000750	380/12 NK	15	120.0	48	17.6
10000754	380/14 NK	15	120.0	40	20.0
10000758	380/16 NKS	12	96.0	48	18.1



Item No.	Description	Fastener Type	Length from - to in mm	Capacity/Pieces	Weight (net)
12000150	195/25-526	195	15 - 25	135	1.8 kg



12200081	195/25-526 with 130 mm throat	195	15 - 25	135	2.2 kg
----------	-------------------------------	-----	---------	-----	--------



Item No.	Description	Mille/Box	Mille/Carton	Cartons/Pallet	kg/Carton
10000706	195/15 NK	5	50.0	40	18.0
10000707	195/18 NK	5	40.0	40	16.5
10000708	195/21 NK	5	30.0	40	14.0
10000709	195/25 NK	5	30.0	40	15.0

BeA Hog Ring Pliers

Item No.	Description	Fastener Type	Length from - to in mm	Capacity/Pieces	Weight (net)
	12100000 BeA Hog Ring Plier HR 60-22	Hog Ring CL 22	-	140	1.6 kg

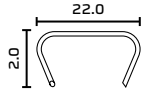

Item No.	Description	Mille/Box	Mille/Carton	Cartons/Pallet	kg/Carton
10000767	Hog Ring CL 22	2.0	24.0	40	24.5

Item No.	Description	Fastener Type	Length from - to in mm	Capacity/Pieces	Weight (net)
	12100604 BeA Hog Ring Plier CL 20 Flex-HR 65 LN	Hog Ring CL 20	-	140	1.6 kg

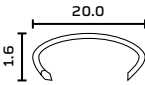

Item No.	Description	Mille/Box	Mille/Carton	Cartons/Pallet	kg/Carton
10001916	Hog Ring CL 20 x 1.6 NK Flexible	4.2	33.6	40	15.5

Item No.	Description	Fastener Type	Length from - to in mm	Capacity/Pieces	Weight (net)
	12100447 BeA Hog Ring Plier CL 24-HR 68	Hog Ring CL 24	-	140	1.6 kg

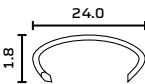

Item No.	Description	Mille/Box	Mille/Carton	Cartons/Pallet	kg/Carton
10001744	Hog Ring CL 24 NK Flexible	5.0	25.0	34	21



BeA Manual Hand and Hammer Tacker

Item No.	Description	Fastener Type	Length from - to in mm	Capacity/Pieces	Weight (net)
	12100029 Hammer Tacker HT19	37	6 - 8	156	0.4 kg

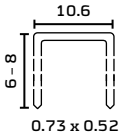
BeA Manual Hand and Hammer Tacker



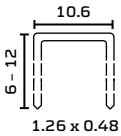

Item No.	Description	Mille/Box	Mille/ Carton	Cartons/ Pallet	kg/ Carton
10000714	37/06 NK	5	325.0	40	18.9
10000715	37/08 NK	5	240.0	40	13.4

Item No.	Description	Fastener Type	Length from - to in mm	Capacity/ Pieces	Weight (net)
 12100028	Hammer Tacker HT11	A 11	6 - 10	168	1.0 kg
 12100505	Hammer Tacker Rapid 311	A 11	6 - 12	168	1.0 kg



Item No.	Description	Mille/Box	Mille/ Carton	Cartons/ Pallet	kg/ Carton
10004652	A 11/06 NK	5	100.0	60	11.5
10000711	A 11/08 NK	5	100.0	40	12.6
10000712	A 11/10 NK	5	100.0	40	14.8
10002246	A 11/12 NK	5	80.0	40	13.9

Item No.	Description	Fastener Type	Length from - to in mm	Capacity/ Pieces	Weight (net)
 12100109	Rapid 53	53	6 - 8	156	0.3 kg
 12100031	Rapid 153	53	6 - 8	156	0.5 kg
 12100032	Rapid 353	53	6 - 14	156	0.8 kg

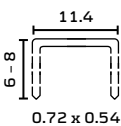

Item No.	Description	Mille/Box	Mille/ Carton	Cartons/ Pallet	kg/ Carton
10003129	R 53/06 NK	2.5	135.0	51	9.3
10003130	R 53/08 NK	2.5	105.0	51	9.4

BeA Pinner

Item No.	Description	Fastener Type	Length from - to in mm	Capacity/Pieces	Weight (net)
	12000052 S 717-410	S 700	10 - 17	130	1.0 kg

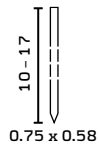

Item No.	Description	Mille/Box	Mille/Carton	Cartons/Pallet	kg/Carton
10100037	S 710 NK	12	288.0	84	8.6
10100038	S 712 NK	12	240.0	84	8.6
10100039	S 714 NK	12	216.0	84	9.3
10100040	S 717 NK	12	168.0	84	8.6

Item No.	Description	Fastener Type	Length from - to in mm	Capacity/Pieces	Weight (net)
	12000439 S 125-569	S 100	14 - 25	126	1.1 kg

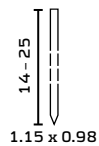

Item No.	Description	Mille/Box	Mille/Carton	Cartons/Pallet	kg/Carton
10100001	S 114 NK	5	90.0	84	9.3
10100003	S 116 NK	5	80.0	84	9.0
10100005	S 119 NK	5	70.0	84	9.7
10100008	S 122 NK	5	60.0	84	9.5
10100010	S 125 NK	5	50.0	84	9.2



BeA Brad Nailers

Item No.	Description	Fastener Type	Length from - to in mm	Capacity/Pieces	Weight (net)
	12000476 SK 240-225C Contact Actuation with case	SK 200	12 - 40	180	1.3 kg



Item No.	Description	Mille/Box	Mille/Carton	Cartons/Pallet	kg/Carton
10300669	SK 215 NK	16.0	160.0	56	12.0
10300666	SK 218 NK	16.0	160.0	56	12.0

BeA Brad Nailers

Item No.	Description	Fastener Type	Length from - to in mm	Capacity/Pieces	Weight (net)
	12100004 SK 335-201 with case	SK 300	10 - 35	100	0.8 kg
	12000225 SK 338-616 C Contact Actuation	SK 300	22 - 38	125	1.6 kg
	12000467 SK 350-224 C Contact Actuation with case	SK 300	18 - 50	104	1.2 kg
	12100666 SK 355-214E Single Actuation with case 	SK 300	15 - 55	100	1.3 kg



Item No.	Description	Mille/Box	Mille/Carton	Cartons/Pallet	kg/Carton
10300449	SK 310 NK	5	100.0	72	8.5
10300261	SK 314 NK	5	100.0	72	13.4
10300643	SK 315 NK	5	100.0	60	13.8
10300670	SK 316 NK	5	100.0	72	15.0
10300268	SK 319 NK	5	100.0	72	17.5
10300644	SK 320 NK	5	60.0	60	10.9
10300272	SK 322 NK	5	100.0	72	19.8
10300645	SK 325 NK	5	60.0	60	13.7
10300646	SK 330 NK	5	60.0	60	16.1
10300717	SK 332 NK	5	60.0	48	17.9
10300648	SK 335 NK	5	50.0	51	16.0
10300649	SK 338 NK	5	50.0	51	16.7
10300650	SK 340 NK	5	50.0	51	17.8
10300651	SK 345 NK	5	40.0	40	16.1
10300652	SK 350 NK	5	40.0	40	17.8
10300337	SK 330 A4	5	60.0	60	17.6
10300338	SK 335 A4	5	50.0	51	16.5



BeA Brad Nailers

Item No.	Description	Fastener Type	Length from - to in mm	Capacity/Pieces	Weight (net)
12100233	SKAM 350-226 C Contact Actuation with case	SKAM 300	20 - 50	128	1.4 kg

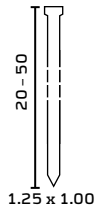

Item No.	Description	Mille/Box	Mille/Carton	Cartons/Pallet	kg/Carton
10300487	SKAM 320 NK	3	60.0	80	11.1
10300488	SKAM 325 NK	3	60.0	60	13.6
10300489	SKAM 332 NK	3	60.0	60	18.7
10300490	SKAM 338 NK	2	40.0	72	14.6
10300491	SKAM 345 NK	2	40.0	64	16.2
10300492	SKAM 350 NK	2	40.0	64	16.8

Item No.	Description	Fastener Type	Length from - to in mm	Capacity/Pieces	Weight (net)
12100427	SK 464-343 C Contact Actuation with case	SK 400	25 - 64	100	1.5 kg
12000256	SK 451-717 C Contact Actuation	SK 400	25 - 51	97	2.2 kg

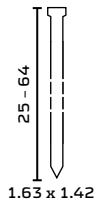

Item No.	Description	Mille/Box	Mille/Carton	Cartons/Pallet	kg/Carton
10300633	SK 425 NK	2	36.0	54	13.9
10300634	SK 432 NK	2	36.0	54	18.0
10300635	SK 435 NK	2	24.0	54	13.2
10300636	SK 438 NK	2	24.0	54	14.9
10300637	SK 445 NK	2	24.0	54	16.9
10300638	SK 450 NK	2	24.0	54	18.1
10300639	SK 455 NK	2	12.0	72	10.2
10300640	SK 457 NK	2	12.0	72	10.7
10300641	SK 460 NK	2	12.0	72	11.0
10300340	SK 438 A4	2	24.0	54	15.1
10300716	SK 464 NK	2	16.0	40	12.2

BeA Brad Nailers



Item No.	Description	Fastener Type	Length from - to in mm	Capacity/Pieces	Weight (net)
12100293	SKAM 450-227 C Contact Actuation with case	SKAM 400	25 - 50	100	1.4 kg

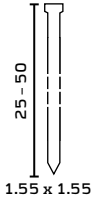

Item No.	Description	Mille/Box	Mille/Carton	Cartons/Pallet	kg/Carton
10300518	SKAM 432 NK	5	20.0	90	11.2
10300519	SKAM 438 NK	5	20.0	90	12.8
10300520	SKAM 445 NK	5	20.0	72	15.2
10300521	SKAM 450 NK	5	20.0	64	16.7



Item No.	Description	Fastener Type	Length from - to in mm	Capacity/Pieces	Weight (net)
12000266	SK 562-804 C Contact Actuation	RSK 500 S 500	40 - 62	103 90	3.3 kg

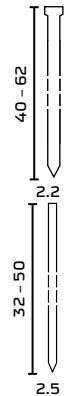

Item No.	Description	Mille/Box	Mille/Carton	Cartons/Pallet	kg/Carton
10300111	RSK 540 NK Brown	-	9.0	85	12.0
10300117	RSK 550 NK Brown	-	9.0	68	14.0
10300119	RSK 554 NK Brown	-	9.0	68	15.0
10300121	RSK 562 NK Brown	-	9.0	68	17.0
10100030	S 532 LM	1.0	18.0	85	8.5
10100031	S 535 LM	1.0	16.0	85	8.5
10100034	S 550 LM	1.0	12.0	85	8.5

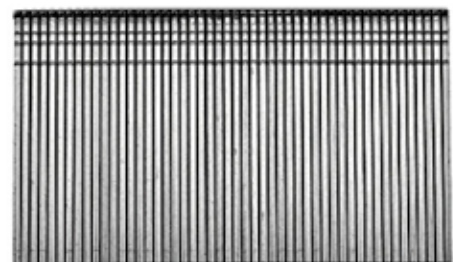

BeA Brad Nailers



Item No.	Description	Fastener Type	Length from - to in mm	Capacity/Pieces	Weight (net)
12100345	SKDA 663-771 C Contact Actuation with case	SKDA 600	32 - 63	100	1.9 kg

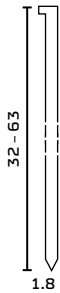

Item No.	Description	Mille/Box	Mille/Carton	Cartons/Pallet	kg/Carton
10300397	SKDA 632 NK HZ	4.0	16.0	56	11.7
10300398	SKDA 638 NK HZ	4.0	16.0	56	13.3
10300399	SKDA 644 NK HZ	4.0	16.0	56	15.4
10300400	SKDA 650 NK HZ	4.0	16.0	56	17.9
10300401	SKDA 656 NK HZ	4.0	16.0	56	21.0
10300402	SKDA 663 NK HZ	4.0	16.0	56	21.8
10300405	SKDA 638 A2 HZ	4.0	16.0	56	13.3
10300407	SKDA 650 A2 HZ	4.0	16.0	56	17.9
10300409	SKDA 663 A2 HZ	4.0	16.0	56	21.8



Item No.	Description	Fastener Type	Length from - to in mm	Capacity/Pieces	Weight (net)
12100331	SKS 650-228 C Contact Actuation with case	Steel-Nails SKS 600	18 - 50	77	1.5 kg

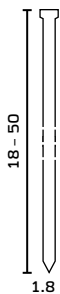

Item No.	Description	Mille/Box	Mille/Carton	Cartons/Pallet	kg/Carton
10300550	SKS 618 NK Steel	3.0	30.0	76	12.8
10300551	SKS 620 NK Steel	3.0	30.0	88	12.3
10300552	SKS 625 NK Steel	3.0	30.0	64	15.3
10300553	SKS 630 NK Steel	3.0	30.0	56	18.4
10300555	SKS 640 NK Steel	1.5	15.0	80	12.7
10300556	SKS 645 NK Steel	1.5	15.0	72	14.2
10300557	SKS 650 NK Steel	1.5	15.0	64	15.7

BeA T Nailer

Item No.	Description	Fastener Type	Length from - to in mm	Capacity/Pieces	Weight (net)
	12000244	T	13 - 25	82	2.7 kg
	12000243	T	25 - 54	82	2.7 kg

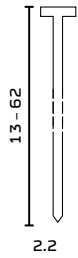

Item No.	Description	Mille/Box	Mille/Carton	Cartons/Pallet	kg/Carton
10200256	T 13 NKS	1.0	20.0	45	9.0
10200257	T 15 NKS	1.0	20.0	45	10.0
10200258	T 18 NKS	1.0	20.0	45	13.0
10200252	T 21 NKS	1.0	10.0	140	8.0
10200259	T 25 NKS	1.0	20.0	45	18.0
10200250	T 32 NKS	2.0	20.0	50	21.0
10200199	T 38 NKS	1.0	10.0	54	13.0
10200241	T 25 NK	1.0	20.0	45	18.0
10200261	T 32 NK	1.0	10.0	54	11.0
10200247	T 38 NK	1.0	10.0	54	14.0
10200246	T 44 NK	1.0	10.0	54	16.0
10200242	T 50 NK	1.0	10.0	54	17.0
10200245	T 54 NK	1.0	10.0	45	18.0
10200244	T 62 NK	1.0	10.0	36	20.0



BeA Nailers for Corrugated Fasteners

Item No.	Description	Fastener Type	Length from - to in mm	Capacity/Pieces	Weight (net)
	12000126	WM 12-156 C Contact Actuation	6 - 12	75	2.8 kg

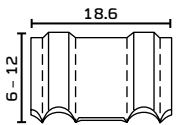

Item No.	Description	Mille/ Carton	Cartons/ Pallet	kg/ Carton
10800000	WM 06 BK A	17.3	85	7.5
10800002	WM 09 BK A	11.5	85	7.9
10800004	WM 12 BK A	8.6	85	8.2

Item No.	Description	Fastener Type	Length from - to in mm	Capacity/Pieces	Weight (net)
	12000133	W 15-358 C Contact Actuation	9 - 15	77	3.0 kg
	14401023	Corner attachment			

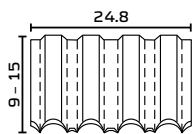

Item No.	Description	Mille/ Carton	Cartons/ Pallet	kg/ Carton
10800007	W 09 BK A	9.2	85	8.4
10800014	W 12 BK A	6.9	85	8.7
10800021	W 15 BK A	5.2	85	8.6

Item No.	Description	Fastener Type	Length from - to in mm	Capacity/Pieces	Weight (net)
	12000610	W 25-826 E Single Actuation	18 - 25	80	3.7 kg

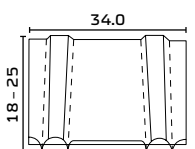

Item No.	Description	Mille/ Carton	Cartons/ Pallet	kg/ Carton
10800043	W 18 BK Maxi	2.7	85	5.4
10800039	W 25 BK Maxi	1.9	85	7.5

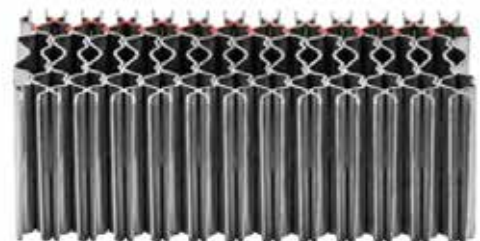

BeA Coil Nailers

Item No.	Description	Fastener Type	Length from - to in mm	Capacity/Pieces	Weight (net)
12100010	550 DC Contact Actuation	BDC	30 - 55 Ø 2.1 - 2.4	1 Coil	2.5 kg
12100456	570 DC Contact Actuation	BDC	25 - 57 Ø 2.1 - 2.5	1 Coil	2.7 kg
12100673	572 DCC Contact Actuation	BDC	25 - 57 Ø 2.1 - 2.5	1 Coil	2.7 kg
12200099	570 DC Two Hand Actuation	BDC	25 - 57 Ø 2.1 - 2.5	1 Coil	3.6 kg



Item No.	Description	Mille/ Carton	Cartons/ Pallet	kg/ Carton
10500628	BDC 2.1 x 35 BK	14.7	40	13.6
10500637	BDC 2.1 x 40 BK	12.6	40	13.3
10500644	BDC 2.1 x 45 BK	12.6	40	15.0
10500650	BDC 2.1 x 50 BK	10.5	40	13.8
10500479	BDC 2.1 x 40 BK Niet	12.6	40	15.2
10500394	BDC 2.1 x 45 BK Niet	12.6	40	15.0
10500419	BDC 2.1 x 27 BK Ring	16.8	40	11.8
10500619	BDC 2.1 x 30 BK Ring	16.8	40	13.4
10500625	BDC 2.1 x 32 BK Ring	16.8	40	14.3
10500629	BDC 2.1 x 35 BK Ring	14.7	40	13.6
10500634	BDC 2.1 x 38 BK Ring	14.7	40	14.8
10500639	BDC 2.1 x 40 BK Ring	12.6	40	13.3
10500646	BDC 2.1 x 45 BK Ring	12.6	40	15.0
10500652	BDC 2.1 x 50 BK Ring	10.5	40	13.8
10500656	BDC 2.1 x 55 BK Ring	10.5	40	18.2
10500642	BDC 2.1 x 40 NK Ring	12.6	40	13.3
10500653	BDC 2.1 x 50 NK Ring	10.5	40	13.8
10500396	BDC 2.3 x 50 BK	10.0	40	15.9
10500397	BDC 2.3 x 55 BK	10.0	40	17.4
10501717	BDC 2.3 x 40 BK Ring	12.0	40	16.4
10501718	BDC 2.3 x 45 BK Ring	12.0	40	17.2
10501719	BDC 2.3 x 50 BK Ring	10.0	40	15.9
10501720	BDC 2.3 x 55 BK Ring	10.0	40	17.4
10500382	BDC 2.5 x 45 BK	10.8	40	19.1
10500429	BDC 2.5 x 50 BK	9.0	40	16.8
10500430	BDC 2.5 x 55 BK	9.0	40	18.4

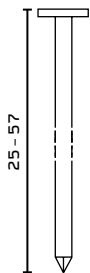





All above mentioned BDC Nails (except the Clinch) have the required characteristics specified in Eurocode 5. Further information on page 18

BeA Coil Nailers



Item No.	Description	Mille/ Carton	Cartons/ Pallet	kg/ Carton
10501724	BDC 2.5 x 42 BK Ring	10.8	40	17.8
10500434	BDC 2.5 x 45 BK Ring	10.8	40	19.1
10500435	BDC 2.5 x 50 BK Ring	9.0	40	16.8
10500436	BDC 2.5 x 55 BK Ring	9.0	40	18.4
10500457	BDC 2.5 x 45 NK Ring	10.8	40	19.1
10500458	BDC 2.5 x 50 NK Ring	9.0	40	16.8
10500459	BDC 2.5 x 55 NK Ring	9.0	40	18.4
10501490	BDC 2.5 x 55 A4 Ring Dome Head	9.0	40	18.4

All above mentioned BDC Nails (except the Clinch) have the required characteristics specified in Eurocode 5.
Further information on page 18

Item No.	Description	Fastener Type	Length from - to in mm	Capacity/ Pieces	Weight (net)
 12100509	559 DC Contact Actuation with case	BDC	32 - 50 BDC Ø 2.1 - 2.3	1 Coil	2.0 kg
 12100648	557DC	BDC + TC	32 - 50 BDC Ø 2.1 - 2.5	1 Coil	2.0 kg
 12100458	567 DC Contact Actuation	BDC + TC	32 - 65 BDC Ø 2.1 - 2.5 TC Ø 2.2 - 2.5	1 Coil	2.1 kg
 12100593	567 DC Single Actuation	BDC + TC	32 - 65 BDC Ø 2.1 - 2.5 TC Ø 2.2 - 2.5	1 Coil	2.1 kg



BeA Coil Nailers



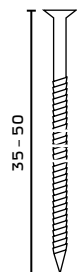
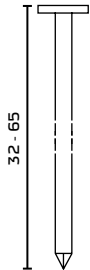

Item No.	Description	Mille/ Carton	Cartons/ Pallet	kg/ Carton
10500644	BDC 2.1 x 45 BK	12.6	40	15.0
10500650	BDC 2.1 x 50 BK	10.5	40	13.8
10500394	BDC 2.1 x 45 BK Niet	12.6	40	15.0
10500646	BDC 2.1 x 45 BK Ring	12.6	40	15.0
10500652	BDC 2.1 x 50 BK Ring	10.5	40	13.8
10500656	BDC 2.1 x 55 BK Ring	10.5	40	18.2
10500653	BDC 2.1 x 50 NK Ring	10.5	40	13.8
10500396	BDC 2.3 x 50 BK	10.0	40	15.9
10500397	BDC 2.3 x 55 BK	10.0	40	17.4
10501714	BDC 2.3 x 60 BK	8.0	40	15.2
10501717	BDC 2.3 x 40 BK Ring	12.0	40	16.4
10501718	BDC 2.3 x 45 BK Ring	12.0	40	17.2
10501719	BDC 2.3 x 50 BK Ring	10.0	40	15.9
10501720	BDC 2.3 x 55 BK Ring	10.0	40	17.4
10500382	BDC 2.5 x 45 BK	10.8	40	19.1
10500429	BDC 2.5 x 50 BK	9.0	40	16.8
10500430	BDC 2.5 x 55 BK	9.0	40	10.78
10500431	BDC 2.5 x 60 BK	7.2	40	11.33
10500141	BDC 2.5 x 65 BK	7.2	40	12.23
10500434	BDC 2.5 x 45 BK Ring	10.8	40	11.08
10500435	BDC 2.5 x 50 BK Ring	9.0	40	11.76
10500436	BDC 2.5 x 55 BK Ring	9.0	40	12.39
10500487	BDC 2.5 x 57 BK Ring	7.2	40	15.48
10500437	BDC 2.5 x 60 BK Ring	7.2	40	13.04
10500146	BDC 2.5 x 65 BK Ring	7.2	40	14.04
10500259	BDC 2.5 x 65 NK	7.2	40	17.85
10500457	BDC 2.5 x 45 NK Ring	10.8	40	15.41
10500458	BDC 2.5 x 50 NK Ring	9.0	40	16.35
10500459	BDC 2.5 x 55 NK Ring	9.0	40	17.24
10500460	BDC 2.5 x 60 NK Ring	7.2	40	18.14
10501271	BDC 2.5 x 65 NK Ring	7.2	40	19.55
10401490	BDC 2.5 x 55 A4 Ring Dome Head	9.0	40	86.92
10501494	BDC 2.5 x 65 A4 Ring Dome Head	7.2	40	125.43
10600017	TC-NG GK 2.5 x 35 NK Ring	8.0	28	31.81
10600029	TC-NG 2.5 x 35 NK PZ	8.0	28	64.12
10600031	TC-NG 2.5 x 40 NK PZ	8.0	28	64.54
10600196	TC-NG 2.5 x 40 NK TX	8.0	28	64.54
10600245	TC-NG 2.5 x 45 NK TX	8.0	28	66.73
10600246	TC-NG 2.5 x 50 NK TX	8.0	28	72.33
10600045	TC-FAS 2.3 x 37 NR RING A2	3.2	105	107.99



All above mentioned BDC Nails (except the TX) have the required characteristics specified in Eurocode 5.
Further information on page 18



BeA Coil Nailers

Item No.	Description	Fastener Type	Length from - to in mm	Capacity/Pieces	Weight (net)
	12100510 564 DC Contact Actuation	BDC	32 - 65 Ø 2.3 - 2.8	1 Coil	2.7 kg
	12100667 702 DCC Contact Actuation	BDC	45 - 70 Ø 2.3 - 2.8	1 Coil	3.6 kg
	12100490 730 DC Contact Actuation	BDC	45 - 70 Ø 2.3 - 2.9	1 Coil	3.8 kg
	12100635 780 DC Contact Actuation	BDC + TC	45 - 70 BDC Ø 2.5 - 3.3 TC Ø 2.3 - 2.5	1 Coil	2.9 kg
14404669	Balancer eye				

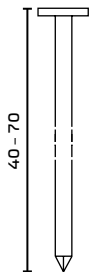

Item No.	Description	Mille/ Carton	Cartons/ Pallet	kg/ Carton
10500396	BDC 2.3 x 50 BK	10.0	40	15.0
10500397	BDC 2.3 x 55 BK	10.0	40	13.8
10501714	BDC 2.3 x 60 BK	8.0	40	15.0
10501717	BDC 2.3 x 40 BK Ring	12.0	40	15.0
10501718	BDC 2.3 x 45 BK Ring	12.0	40	13.8
10501719	BDC 2.3 x 50 BK Ring	10.0	40	18.2
10501720	BDC 2.3 x 55 BK Ring	10.0	40	13.8
10500382	BDC 2.5 x 45 BK	10.8	40	15.9
10500429	BDC 2.5 x 50 BK	9.0	40	17.4
10500430	BDC 2.5 x 55 BK	9.0	40	15.2
10500431	BDC 2.5 x 60 BK	7.2	40	16.4
10500141	BDC 2.5 x 65 BK	7.2	40	17.2
10500156	BDC 2.5 x 70 BK	7.2	40	18.0
10500434	BDC 2.5 x 45 BK Ring	10.8	40	17.4
10500435	BDC 2.5 x 50 BK Ring	9.0	40	19.1
10500436	BDC 2.5 x 55 BK Ring	9.0	40	16.8
10500487	BDC 2.5 x 57 BK Ring	7.2	40	15.5
10500437	BDC 2.5 x 60 BK Ring	7.2	40	16.4
10500146	BDC 2.5 x 65 BK Ring	7.2	40	17.2
10500160	BDC 2.5 x 70 BK Ring	7.2	40	18.0
10500259	BDC 2.5 x 65 NK	7.2	40	17.2
10500457	BDC 2.5 x 45 NK Ring	10.8	40	17.4
10500458	BDC 2.5 x 50 NK Ring	9.0	40	19.1



All above mentioned BDC Nails (except the Clinch) have the required characteristics specified in Eurocode 5. Further information on page 18

BeA Coil Nailers

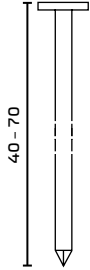

Item No.	Description	Mille/ Carton	Cartons/ Pallet	kg/ Carton
10500459	BDC 2.5 x 55 NK Ring	9.0	40	18.4
10500460	BDC 2.5 x 60 NK Ring	7.2	40	16.1
10501271	BDC 2.5 x 65 NK Ring	7.2	40	17.4
10500690	BDC 2.5 x 65 FV Ring	7.2	40	17.4
10401490	BDC 2.5 x 55 NR Ring Dome Head	9.0	40	18.4
10501494	BDC 2.5 x 65 NR Ring Dome Head	7.2	40	19.0
10500122	BDC 2.8 x 60 BK	6.0	40	18.0
10500144	BDC 2.8 x 65 BK	6.0	40	18.8
10501259	BDC 2.8 x 70 BK	6.0	40	20.0
10500126	BDC 2.8 x 60 BK Ring	6.0	40	18.0
10501258	BDC 2.8 x 65 BK Ring	6.0	40	18.8
10500161	BDC 2.8 x 70 BK Ring	6.0	40	20.0
10500957	BDC 2.8 x 65 BK Screw	6.0	40	19.2
10501159	BDC 2.8 x 70 BK Screw	6.0	40	20.5
10501260	BDC 2.8 x 70 NK	6.0	40	20.0
10500138	BDC 2.8 x 65 NK Ring	6.0	40	18.8
10500155	BDC 2.8 x 70 NK Ring	6.0	40	20.0
10501546	BDC 2.8 x 65 NR Ring Dome Head	6.0	40	18.8
10501059	BDC 2.8 x 65 NK Screw TX	6.0	40	19.7
10501611	BDC 2.8 x 80 NK Screw TX	3.96	40	15.6

All above mentioned BDC Nails (except the TX) have the required characteristics specified in Eurocode 5. Further information on page 18



10500370	BDC 2.8/3.0 x 40 BK Ring EPAL	8.1	40	16.6
----------	-------------------------------	-----	----	------

Certified by the European Pallet Association (EP)



Item No.	Description	Fastener Type	Length from - to in mm	Capacity/Pieces	Weight (net)
12100670	802 DCC Contact Actuation 	BDC	50 - 80 Ø 2.5 - 3.1	1 Coil	3.8 kg
12100068	900 DC Contact Actuation	BDC	45 - 90 Ø 2.5 - 3.8	1 Coil	3.3 kg



BeA Coil Nailers

	Item No.	Description	Fastener Type	Length from - to in mm	Capacity/Pieces	Weight (net)
	12100457	830 DC Contact Actuation	BDC	50 - 83 Ø 2.5 - 3.3	1 Coil	3.8 kg
	12100596	830 DC Single Actuation	BDC	50 - 83 Ø 2.5 - 3.3	1 Coil	3.8 kg
	12100511	904 DC Contact Actuation	BDC	45 - 90 Ø 2.5 - 3.3	1 Coil	3.6 kg
	12100462	901 DC Contact Actuation with case	BDC	50 - 90 Ø 2.5 - 3.3	1 Coil	3.8 kg
	12100597	901 DC Single Actuation with case	BDC	50 - 90 Ø 2.5 - 3.3	1 Coil	3.8 kg
	12100470	903 DC Contact Actuation with case	BDC + TC	BDC 45 - 90 Ø 2.5 - 3.8 TC 45 - 75 Ø 2.5 - 3.0	1 Coil	3.0 kg
	12100598	903 DC Single Actuation with case	BDC + TC	BDC 45 - 90 Ø 2.5 - 3.8 TC 45 - 75 Ø 2.5 - 3.0	1 Coil	3.0 kg



BeA Coil Nailers

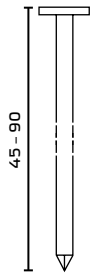

Item No.	Description	Mille/ Carton	Cartons/ Pallet	kg/ Carton
10500382	BDC 2.5 x 45 BK	10.8	40	15.0
10500429	BDC 2.5 x 50 BK	9.0	40	13.8
10500430	BDC 2.5 x 55 BK	9.0	40	15.0
10500431	BDC 2.5 x 60 BK	7.2	40	15.0
10500141	BDC 2.5 x 65 BK	7.2	40	13.8
10500156	BDC 2.5 x 70 BK	7.2	40	18.2
10500434	BDC 2.5 x 45 BK Ring	10.8	40	13.8
10500435	BDC 2.5 x 50 BK Ring	9.0	40	15.9
10500436	BDC 2.5 x 55 BK Ring	9.0	40	17.4
10500487	BDC 2.5 x 57 BK Ring	7.2	40	15.2
10500437	BDC 2.5 x 60 BK Ring	7.2	40	16.4
10500146	BDC 2.5 x 65 BK Ring	7.2	40	17.2
10500160	BDC 2.5 x 70 BK Ring	7.2	40	15.9
10500259	BDC 2.5 x 65 NK	7.2	40	17.4
10500457	BDC 2.5 x 45 NK Ring	10.8	40	19.1
10500458	BDC 2.5 x 50 NK Ring	9.0	40	16.8
10500459	BDC 2.5 x 55 NK Ring	9.0	40	18.5
10500460	BDC 2.5 x 60 NK Ring	7.2	40	16.1
10501271	BDC 2.5 x 65 NK Ring	7.2	40	17.4
10500690	BDC 2.5 x 65 FV Ring	7.2	40	17.4
10500464	BDC 2.5 x 55 NR Ring Dome Head	9.0	40	18.4
10500465	BDC 2.5 x 65 NR Ring Dome Head	8.0	40	19.3
10500122	BDC 2.8 x 60 BK	6.0	40	18.0
10500144	BDC 2.8 x 65 BK	6.0	40	18.8
10501259	BDC 2.8 x 70 BK	6.0	40	20.0
10500173	BDC 2.8 x 75 BK	4.5	40	16.8
10500183	BDC 2.8 x 80 BK	4.5	40	17.1
10500126	BDC 2.8 x 60 BK Ring	6.0	40	18.0
10501258	BDC 2.8 x 65 BK Ring	6.0	40	18.8
10500161	BDC 2.8 x 70 BK Ring	6.0	40	20.0
10500176	BDC 2.8 x 75 BK Ring	4.5	40	16.8
10500186	BDC 2.8 x 80 BK Ring	4.5	40	17.1
10501183	BDC 2.8 x 90 BK Ring	4.5	40	20.1
10500957	BDC 2.8 x 65 BK Screw	6.0	40	19.2
10501159	BDC 2.8 x 70 BK Screw	6.0	40	20.5
10501261	BDC 2.8 x 75 BK Screw	4.5	40	16.8
10500188	BDC 2.8 x 80 BK Screw	4.5	40	17.1
10501260	BDC 2.8 x 70 NK	6.0	40	20.0
10500314	BDC 3.1 x 70 NK	4.8	40	20.7
10501251	BDC 3.1 x 80 NK	3.6	40	17.1
10501254	BDC 3.1 x 90 NK	3.6	40	18.9
10500138	BDC 2.8 x 65 NK Ring	6.0	40	18.8
10500155	BDC 2.8 x 70 NK Ring	6.0	40	20.0
10501162	BDC 2.8 x 75 NK Ring	4.5	40	16.8



All above mentioned BDC Nails (except the Clinch) have the required characteristics specified in Eurocode 5.
Further information on page 18.

BeA Coil Nailers

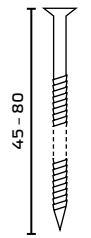

Item No.	Description	Mille/ Carton	Cartons/ Pallet	kg/ Carton
10501546	BDC 2.8 x 65 NR Ring Dome Head	6.0	40	18.8
10501496	BDC 2.8 x 70 NR Ring Dome Head	6.0	40	20.0
10401814	BDC 2.8 x 80 NR Ring Dome Head	4.5	40	17.6
10501247	BDC 3.1 x 70 BK	4.8	40	19.4
10500184	BDC 3.1 x 80 BK	3.6	40	17.6
10500198	BDC 3.1 x 90 BK	3.6	40	19.8
10501248	BDC 3.1 x 70 BK Ring	4.8	40	19.4
10501511	BDC 3.1 x 80 BK Ring	3.6	40	17.6
10500201	BDC 3.1 x 90 BK Ring	3.6	40	19.8
10501252	BDC 3.1 x 80 NK Ring	3.6	40	16.6
10501255	BDC 3.1 x 90 NK Ring	3.6	40	18.4
10500189	BDC 3.1 x 80 BK Screw	3.6	40	17.5
10500202	BDC 3.1 x 90 BK Screw	3.6	40	19.8
10500204	BDC 3.1 x 90 FV Screw	3.6	40	18.9
10501533	BDC 3.1 x 90 NR Ring Dome Head	3.6	40	18.9
10501059	BDC 2.8 x 65 NK Screw TX	6.0	40	19.7
10501611	BDC 2.8 x 80 NK Screw TX	4.0	40	15.6
10600245	TC 2.5 x 45 NK Screw TX	8.0	28	14.2
10600246	TC 2.5 x 50 NK Screw TX	8.0	28	15.7

All above mentioned BDC Nails (except the Clinch) have the required characteristics specified in Eurocode 5.
Further information on page 18

BeA Recipro Saber Saw Blades

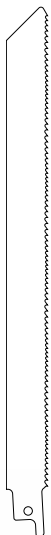

Item No.	Description	Dimension in mm	Teething	Tip
11700001	Recipro 200x0.9x19 VTNT	200x0.9x19	Vario-Teething (10-14 TPI)	Normal sharp tip
11700002	Recipro 230x0.9x19 VTNT	230x0.9x19	Vario-Teething (10-14 TPI)	Normal sharp tip
11700003	Recipro 200x1.25x19 VTNT	200x1.25x19	Vario-Teething (10-14 TPI)	Normal sharp tip
11700004	Recipro 230x1.25x19 VTNT	230x1.25x19	Vario-Teething (10-14 TPI)	Normal sharp tip
11700011	Recipro 230x0.9x19 WTNT	230x0.9x19	Wood-Teething (10 TPI)	Normal sharp tip
11700018	Recipro 190x1.25x19 VVRT	190x1.25x19	Vario-Teething (10-14 TPI)	Reverse sharp tip
11700020	Recipro 200x0.9x19 WTNT	200x0.9x19	Wood-Teething (10 TPI)	Normal sharp tip
11700021	Recipro 200x1.25x19 WINT	200x1.25x19	Wood-Teething (10 TPI)	Normal sharp tip
11700023	Recipro 190x0.9x19 VVRT	190x0.9x19	Vario-Teething (10-14 TPI)	Reverse sharp tip
11700024	Recipro 225x0.9x19 VVRT	225x0.9x19	Vario-Teething (10-14 TPI)	Reverse sharp tip
11700025	Recipro 225x1.25x19 VVRT	225x1.25x19	Vario-Teething (10-14 TPI)	Reverse sharp tip



BeA Skater



Item No.	Description	Fastener Type	Length from - to in mm	Capacity/Pieces	Weight (net)
14412430 12000629	Skater 800 DC	BDC	60 - 70 Ø 2.5 - 3.1	300	11.8 kg



Item No.	Description	Mille/ Carton	Cartons/ Pallet	kg/ Carton
10500431	BDC 2.5 x 60 BK	7.2	40	15.0
10500141	BDC 2.5 x 65 BK	7.2	40	13.8
10500156	BDC 2.5 x 70 BK	7.2	40	18.2
10500437	BDC 2.5 x 60 BK Ring	7.2	40	16.4
10500146	BDC 2.5 x 65 BK Ring	7.2	40	17.2
10500160	BDC 2.5 x 70 BK Ring	7.2	40	15.9
10500259	BDC 2.5 x 65 NK	7.2	40	17.4
10500460	BDC 2.5 x 60 NK Ring	7.2	40	16.1
10501271	BDC 2.5 x 65 NK Ring	7.2	40	17.4
10500690	BDC 2.5 x 65 FV Ring	7.2	40	17.4
10500465	BDC 2.5 x 65 NR Ring Dome Head	8.0	40	19.3
10500122	BDC 2.8 x 60 BK	6.0	40	18.0
10500144	BDC 2.8 x 65 BK	6.0	40	18.8
10501259	BDC 2.8 x 70 BK	6.0	40	20.0
10500126	BDC 2.8 x 60 BK Ring	6.0	40	18.0
10501258	BDC 2.8 x 65 BK Ring	6.0	40	18.8
10500161	BDC 2.8 x 70 BK Ring	6.0	40	20.0
10500957	BDC 2.8 x 65 BK Screw	6.0	40	19.2
10501159	BDC 2.8 x 70 BK Screw	6.0	40	20.5
10501260	BDC 2.8 x 70 NK	6.0	40	20.0
10500314	BDC 3.1 x 70 NK	4.8	40	20.7
10500138	BDC 2.8 x 65 NK Ring	6.0	40	18.8
10500155	BDC 2.8 x 70 NK Ring	6.0	40	20.0
10501546	BDC 2.8 x 65 NR Ring Dome Head	6.0	40	18.8
10501496	BDC 2.8 x 70 NR Ring Dome Head	6.0	40	20.0
10501247	BDC 3.1 x 70 BK	4.8	40	19.4



All above mentioned BDC Nails (except the Clinch) have the required characteristics specified in Eurocode 5.
Further information on page 18



BeA Skater

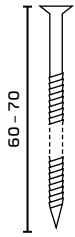

Item No.	Description	Mille/ Carton	Cartons/ Pallet	kg/ Carton
10501248	BDC 3.1 x 70 BK Ring	4.8	40	19.4
10501059	BDC 2.8 x 65 NK Screw TX	6.0	40	19.7

All above mentioned BDC Nails (except the TX) have the required characteristics specified in Eurocode 5.
Further information on page 18





Item No. Accessories for Skater 800 DC



14412428	Edge guide
14412429	Extension handle
14406482	Rail 3 m (connected with edge guide)
14409063	Rail 3.5 m (connected with edge guide)
14412767	Rail guide set

BeA Coil Nailers

Item No.	Description	Fastener Type	Length from - to in mm	Capacity/ Pieces	Weight (net)
 12100492	102 DC Contact Actuation	BDC	55 - 100 Ø 2.5 - 3.8	1 Coil	5.3 kg
 12200100	102 DC Two Hand Actuation	BDC	55 - 100 Ø 2.5 - 3.8	1 Coil	7.2 kg



BeA Coil Nailers



Item No.	Description	Mille/ Carton	Cartons/ Pallet	kg/ Carton
10500141	BDC 2.5 x 65 BK	7.2	40	15.0
10500156	BDC 2.5 x 70 BK	7.2	40	13.8
10500146	BDC 2.5 x 65 BK Ring	7.2	40	15.0
10500160	BDC 2.5 x 70 BK Ring	7.2	40	15.0
10501271	BDC 2.5 x 65 NK Ring	7.2	40	13.8
10500690	BDC 2.5 x 65 FV Ring	7.2	40	18.2
10501494	BDC 2.5 x 65 NR Ring Dome Head	7.2	40	13.8
10500144	BDC 2.8 x 65 BK	6.0	40	15.9
10501259	BDC 2.8 x 70 BK	6.0	40	17.4
10500173	BDC 2.8 x 75 BK	4.5	40	15.2
10500183	BDC 2.8 x 80 BK	4.5	40	16.4
10501258	BDC 2.8 x 65 BK Ring	6.0	40	17.2
10500161	BDC 2.8 x 70 BK Ring	6.0	40	15.9
10500176	BDC 2.8 x 75 BK Ring	4.5	40	17.4
10500186	BDC 2.8 x 80 BK Ring	4.5	40	19.1
10500957	BDC 2.8 x 65 BK Screw	6.0	40	16.8
10501159	BDC 2.8 x 70 BK Screw	6.0	40	20.1
10501261	BDC 2.8 x 75 BK Screw	4.5	40	16.8
10500188	BDC 2.8 x 80 BK Screw	4.5	40	17.1
10501260	BDC 2.8 x 70 NK	6.0	40	20.0
10500138	BDC 2.8 x 65 NK Ring	6.0	40	18.8
10500155	BDC 2.8 x 70 NK Ring	6.0	40	20.0
10501162	BDC 2.8 x 75 NK Ring	4.5	40	16.8
10501059	BDC 2.8 x 65 NK Screw TX	6.0	40	19.7
10501611	BDC 2.8 x 80 NK Screw TX	4.0	40	15.2
10501247	BDC 3.1 x 70 BK	4.8	40	19.4
10500184	BDC 3.1 x 80 BK	3.6	40	17.6
10500198	BDC 3.1 x 90 BK	3.6	40	19.8
10501248	BDC 3.1 x 70 BK Ring	4.8	40	19.4
10501511	BDC 3.1 x 80 BK Ring	3.6	40	17.6
10500201	BDC 3.1 x 90 BK Ring	3.6	40	19.8
10501252	BDC 3.1 x 80 NK Ring	3.6	40	16.6
10501255	BDC 3.1 x 90 NK Ring	3.6	40	18.4
10500189	BDC 3.1 x 80 BK Screw	3.6	40	17.6
10500202	BDC 3.1 x 90 BK Screw	3.6	40	19.8
10500204	BDC 3.1 x 90 FV Screw	3.6	40	18.9
10501533	BDC 3.1 x 90 A4 Ring	3.6	40	18.9



All above mentioned BDC Nails (except the Clinch) have the required characteristics specified in Eurocode 5.
Further information on page 18.

BeA Coil Nailers

Item No.	Description	Fastener Type	Length from - to in mm	Capacity/Pieces	Weight [net]	
	12100468	102 DC EPAL Contact Actuation	EPAL-Coil Nails	70 + 90 Ø 3.4 + 4.0	1 Coil	5.3 kg

Item No.	Description	Mille/ Carton	Cartons/ Pallet	kg/ Carton
10500342	BDC 3.4/4.0 x 70 BK Ring EPAL	4.3	30	19.0
10502124	BDC 3.3/4.0 x 90 BK Ring EPAL	3.2	40	17.8

Certified by the European Pallet Association (EP)



Item No.	Description	Fastener Type	Length from - to in mm	Capacity/Pieces	Weight [net]	
	12100459	130 DC Contact Actuation	BDC	75 - 130 Ø 3.1 - 3.8	1 Coil	5.8 kg

Item No.	Description	Mille/ Carton	Cartons/ Pallet	kg/ Carton
10501776	BDC 3.8 x 110 BK	1.8	40	20.2
10501773	BDC 3.8 x 120 BK	1.8	40	21.6
10501785	BDC 3.8 x 130 BK	1.8	40	23.4
10501769	BDC 3.8 x 120 BK Ring	1.8	40	22.2
10501811	BDC 3.8 x 130 BK Ring	1.8	40	23.9
10501790	BDC 3.8 x 120 BK Screw	1.8	40	22.2
10501792	BDC 3.8 x 130 BK Screw	1.8	40	23.9
10500315	BDC 3.8 x 120 NK Ring	1.8	40	22.2
10501830	BDC 3.8 x 130 NK Ring	1.8	40	23.9

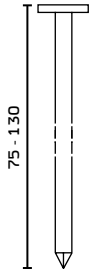

All above mentioned BDC Nails (except the Clinch) have the required characteristics specified in Eurocode 5. Further information on page 18



BeA Coil Nailers for Roofing Nails



Item No.	Description	Fastener Type	Length from - to in mm	Capacity/Pieces	Weight (net)
12100609	556 DC Contact Actuation with case	DPN	19 - 45 Ø 3.1	1 Coil	2.3 kg

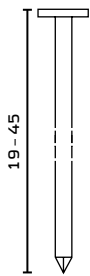

Item No.	Description	Mille/ Carton	Cartons/ Pallet	kg/ Carton
10500001	DPN 3.1 x 19 NK	7.2	36	10.0
10500004	DPN 3.1 x 22 NK	7.2	36	10.7
10500007	DPN 3.1 x 25 NK	7.2	36	12.9
10500010	DPN 3.1 x 32 NK	7.2	36	14.7
10500013	DPN 3.1 x 38 NK	7.2	24	18.2
10500016	DPN 3.1 x 45 NK	7.2	24	21.9
10500002	DPN 3.1 x 19 FV	7.2	36	10.0
10500005	DPN 3.1 x 22 FV	7.2	36	10.7
10500008	DPN 3.1 x 25 FV	7.2	36	12.9
10500011	DPN 3.1 x 32 FV	7.2	36	14.7
10500014	DPN 3.1 x 38 FV	7.2	24	18.2
10500595	DPN 3.1 x 19 NK Ring	7.2	36	10.5
10500596	DPN 3.1 x 22 NK Ring	7.2	36	11.3
10500597	DPN 3.1 x 25 NK Ring	7.2	36	13.3
10500623	DPN 3.1 x 32 NK Ring	7.2	36	15.1

Plastic collated Nails for SN 40-351

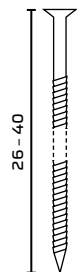

Item No.	Description	Mille/ Carton	Cartons/ Pallet	kg/ Carton
Plasterboard Nails				
10600314	TC-NG GK 22 x 30 NK Ring*	10.8	40	9.7
Nail Screws with recessed Phillips head				
10600146	TC 2.0 x 26 NK Screw PZ	8.0	40	7.2
10600025	TC 2.5 x 26 NK Screw PZ	8.0	28	7.4
10600027	TC 2.5 x 30 NK Screw PZ	8.0	28	9.4
10600029	TC 2.5 x 35 NK Screw PZ	8.0	28	11.0
10600031	TC 2.5 x 40 NK Screw PZ	8.0	28	8.8
10600196	TC 2.5 x 40 NK Screw TX	8.0	28	12.6
Copper Roofing Pins				
10600262	TC 2.6/2.8 x 26 A2 Copper Roof Nails	3.6	100	5.9
Slate Pins				
10600115	TC 2.8 x 35 FV Slate	3.2	105	6.5
10600263	TC 2.8 x 35 A2 Ring Slate	3.6	100	7.3
Facade Nails				
10600045	TC 2.3 x 37 A2 Ring Dark Grey	3.2	105	3.8

* Conforms to DIN 18182 Part 2

BeA Anchor Nailer



Item No.	Description	Fastener Type	Length from - to in mm	Capacity/Pieces	Weight (net)
12100506	Anchor Nailer AN 560 TC Single Actuation with case	TC Anchor Nails	40 - 60 Ø 4.0	1 Coil	2.3 kg

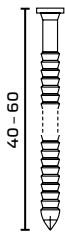

Item No.	Description	Mille/ Carton	Cartons/ Pallet	kg/ Carton
10600195	TC Anchor Nails 4.0 x 40 NK Ring	2.0	60	8.6
10600296	TC Anchor Nails 4.0 x 50 NK Ring	2.0	60	11.2
10600514	TC Anchor Nails 4.0 x 60 NK Ring	2.0	60	10.7

Collating angle = 16°. Not for Multifix 300

All above mentioned Anchor Nails have the required characteristics specified in Eurocode 5. Further information on page 18



Item No.	Description	Fastener Type	Length from - to in mm	Capacity/Pieces	Weight (net)
12100436	Anchor Nailer R 60-943 E Single Actuation with case	R20 Anchor Nails	40 - 60 Ø 4.0	28	2.5 kg



Item No.	Description	Mille/ Carton	Cartons/ Pallet	kg/ Carton
10401172	R20 4.0 x 40 NK Ring	1.0	84	4.6
10401173	R20 4.0 x 50 NK Ring	1.0	84	5.4
10401174	R20 4.0 x 60 NK Ring	1.0	84	6.3

All above mentioned Anchor Nails have the required characteristics specified in Eurocode 5. Further information on page 18

Anchor Nails in a versatile plastic container are available on request



BeA Anchor Nailer

Item No.	Description	Fastener Type	Length from - to in mm	Capacity/Pieces	Weight (net)	
	12100507	Anchor Nailer AN R60-34° E Single Actuation	R34 Anchor Nails	40 - 60 Ø 4.0	25	2.3 kg

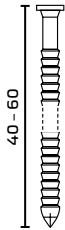

Item No.	Description	Mille/ Carton	Cartons/ Pallet	kg/ Carton
10401267	R34 4.0 x 40 NK Ring	1.25	84	5.6
10401268	R34 4.0 x 50 NK Ring	1.25	84	7.2
10401269	R34 4.0 x 60 NK Ring	1.25	84	8.3

All above mentioned Anchor Nails have the required characteristics specified in Eurocode 5. Further information on page 18

Anchor Nails for Multifix TC 300



Item No.	Description	Mille/ Carton	Cartons/ Pallet	kg/ Carton
10600064	TC 4.0 x 40 NK Ring Anchor Nails	3.0	40	13.1
10600065	TC 4.0 x 50 NK Ring Anchor Nails	2.4	40	12.3
10600066	TC 4.0 x 60 NK Ring Anchor Nails	2.4	40	14.5
10600067	TC 4.0 x 75 NK Ring Anchor Nails	1.8	40	15.3



All above mentioned Anchor Nails have the required characteristics specified in Eurocode 5. Further information on page 18



Please ask for our comprehensive HVV timber connector catalogue



BeA Strip Nailers for Paper collated D Head Nails

Item No.	Description	Fastener Type	Length from - to in mm	Capacity/Pieces	Weight (net)	
	12100234	D 100-934 C Contact Actuation with case	Paper Collated D Head Nails	50 - 100 Ø 2.9 - 3.4	90	3.5 kg
		12100601	D 100-934 C Single Actuation with case	Paper Collated D Head Nails	50 - 100 Ø 2.9 - 3.4	90

BeA Strip Nailers for Paper collated D Head Nails

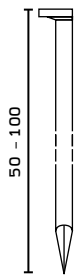



Item No.	Description	Mille/ Carton	Cartons/ Pallet	kg/ Carton
10400817	D34 2.9 x 65 BK	5.0	48	17.9
10400561	D34 2.9 x 70 BK	5.0	48	19.2
10400775	D34 2.9 x 76 BK	4.0	48	16.6
10400626	D34 2.9 x 80 BK	3.0	48	13.3
10400562	D34 3.1 x 83 BK	3.0	48	15.3
10400563	D34 3.1 x 90 BK	3.0	48	16.5
10400564	D34 3.4 x 90 BK	3.0	48	19.8
10400565	D34 3.4 x 100 BK	3.0	48	21.9
10400820	D34 2.9 x 65 NK	5.0	48	17.9
10400630	D34 2.9 x 70 NK	5.0	48	19.6
10400567	D34 3.1 x 83 NK	3.0	48	15.3
10400568	D34 3.1 x 90 NK	3.0	48	16.5
10400569	D34 3.4 x 90 NK	3.0	48	19.8
10400570	D34 3.4 x 100 NK	3.0	48	21.9
10400571	D34 2.9 x 50 BK Ring	6.6	48	18.4
10400818	D34 2.9 x 65 BK Ring	5.0	48	17.9
10400589	D34 2.9 x 70 BK Ring	5.0	48	19.3
10400573	D34 2.9 x 76 BK Ring	4.0	48	16.6
10400776	D34 2.9 x 80 BK Ring	3.0	48	13.3
10400574	D34 3.1 x 83 BK Ring	3.0	48	15.3
10400575	D34 3.1 x 90 BK Ring	3.0	48	16.5
10400576	D34 3.1 x 100 BK Ring	3.0	48	18.9
10400821	D34 2.9 x 65 NK Ring	5.0	48	17.9
10400746	D34 2.9 x 76 NK Ring	4.0	48	16.8
10401342	D34 2.9 x 80 NK Ring	3.0	48	13.8
10400578	D34 3.1 x 83 NK Ring	3.0	48	15.3
10400597	D34 3.1 x 90 NK Ring	3.0	48	17.0
10400627	D34 3.1 x 90 FV	3.0	48	17.4
10400579	D34 2.9 x 50 FV Ring	6.6	48	19.3
10400819	D34 2.9 x 65 FV Ring	5.0	48	18.3
10400581	D34 2.9 x 76 FV Ring	4.0	48	17.4
10400582	D34 3.1 x 90 FV Ring	3.0	48	17.4
10400583	D34 3.1 x 100 FV Ring	3.0	48	19.9



All above mentioned D Head Nails have the required characteristics specified in Eurocode 5.
Further information provided on page 14



BeA Strip Nailers

Item No.	Description	Fastener Type	Length from - to in mm	Capacity/Pieces	Weight (net)
	12100292 R100-952 C Contact Actuation with case	Nails R 20	60 - 100 Ø 2.8 - 3.4	70	3.7 kg
	12100602 R100-952 E Single Actuation with case	Nails R 20	60 - 100 Ø 2.8 - 3.4	70	3.7 kg





Item No.	Description	Mille/ Carton	Cartons/ Pallet	kg/ Carton
10400015	R20 2.8 x 60 BK	3.0	60	9.0
10400020	R20 2.8 x 65 BK	3.0	60	9.8
10400029	R20 2.8 x 70 BK	3.0	60	10.5
10400022	R20 2.8 x 65 BK Ring	3.0	60	10.3
10401341	R20 2.8 x 80 BK Ring	3.0	60	15.2
10400021	R20 3.1 x 65 BK	3.0	60	11.9
10400030	R20 3.1 x 70 BK	3.0	60	12.8
10400044	R20 3.1 x 80 BK	3.0	60	14.7
10400054	R20 3.1 x 90 BK	3.0	60	16.5
10400032	R20 3.1 x 70 BK Screw	3.0	60	12.8
10400047	R20 3.1 x 80 BK Screw	3.0	60	14.7
10400055	R20 3.1 x 90 BK Screw	3.0	60	16.5
10400017	R20 2.8 x 65 NK	3.0	60	9.8
10400026	R20 2.8 x 70 NK	3.0	60	10.5
10400041	R20 3.1 x 80 NK	3.0	60	14.7
10400051	R20 3.1 x 90 NK	3.0	60	16.5
10400053	R20 3.1 x 90 NK Screw	3.0	60	16.5
10400076	R20 3.4 x 100 BK	1.5	60	10.4
10400074	R20 3.4 x 100 NK	1.5	50	10.4



All above mentioned D Head Nails have the required characteristics specified in Eurocode 5.
Further information on page 18



BeA Strip Nailers

Item No.	Description	Fastener Type	Length from - to in mm	Capacity/Pieces	Weight (net)
	12000597 R 130-957 E Single Actuation	Nails R 20	80 - 130 Ø 3.1 - 4.2	65	6.4 kg
	12100472 R 130-959 E Single Actuation	Nails R 20	90 - 130 Ø 3.8 - 5.0	65	6.4 kg
	12000601 R 160-962 E Single Actuation Full Sequential Actuation	Nails R 20	100 - 160 Ø 3.8 - 5.0	50	7.2 kg
	12100473 R 160-965 E Single Actuation Full Sequential Actuation	Nails R 20	100 - 160 Ø 3.8 - 4.6	50	6.9 kg
	12000604 R 220-970 E Single Actuation Full Sequential Actuation	Nails R 20	145 - 220 Ø 4.6 - 5.0	40	8.5 kg



BeA Strip Nailers

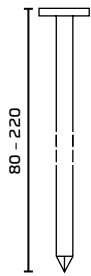

Item No.	Description	Mille/ Carton	Cartons/ Pallet	kg/ Carton
10400077	R20 3.8 x 100 BK	1.5	50	13.5
10400060	R20 3.8 x 110 BK	1.5	50	14.9
10400062	R20 3.8 x 120 BK	1.5	50	16.3
10400067	R20 3.8 x 130 BK	1.5	50	17.8
10400064	R20 3.8 x 120 BK Screw	1.5	50	16.3
10400463	R20 3.8 x 130 BK Screw	1.5	50	17.8
10400462	R20 3.8 x 130 BK Ring	1.5	50	17.8
10400197	R20 3.8X120 NK	1.5	50	16.7
10400065	R20 3.8 x 130 NK	1.5	50	17.8
10400068	R20 4.2 x 130 BK	1.5	50	21.6
10400402	R20 4.2 x 160 BK	0.7	60	11.4
10401340	R20 4.2 x 160 BK Screw	0.7	60	11.8
10400069	R20 4.6 x 145 BK	0.7	60	13.5
10400070	R20 4.6 x 160 BK	0.7	60	14.1
10401193	R20 4.6 x 180 BK Ring	0.6	44	13.5
10400464	R20 4.6 x 160 BK Screw	0.7	60	17.8
10401048	R20 5.0 x 180 BK	0.6	44	15.6
10401047	R20 5.0 x 200 BK	0.6	36	17.4
10401049	R20 4.6 x 220 BK	0.6	36	15.6
10400006	R20 4.6 x 160 NK	0.7	60	13.9

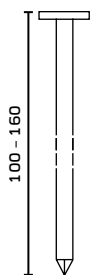

All above mentioned D Head Nails have the required characteristics specified in Eurocode 5.
Further information on page 18



Item No.	Description	Mille/ Carton	Cartons/ Pallet	kg/ Carton
10401848	RP20 3.8 x 100 BK	1.5	50	15.3
10401300	RP20 3.8 x 110 BK	1.5	50	15.7
10401301	RP20 3.8 x 120 BK	1.5	50	17.2
10401303	RP20 3.8 x 130 BK	1.5	50	18.7
10401302	RP20 3.8 x 120 BK Screw	1.5	50	17.2
10401304	RP20 3.8 x 130 BK Screw	1.5	50	18.7
10401846	RP20 3.8 x 130 BK Ring	1.5	50	18.7
10401849	RP20 3.8 x 120 NK	1.5	50	17.2
10401844	RP20 3.8 x 130 NK	1.5	50	18.7
10401843	RP20 3.8 x 110 NK Screw	1.5	50	15.7
10401845	RP20 3.8 x 130 NK Screw	1.5	50	18.7
10401850	RP20 4.2 x 130 BK	1.5	50	25.9
10401847	RP20 4.2 x 150 BK	0.66	60	11.7
10401305	RP20 4.2 x 160 BK	0.66	60	11.9
10401852	RP20 4.2 x 160 BK Screw	0.66	60	11.9
10401851	RP20 4.2 x 160 BK Ring	0.66	60	11.9
10401306	RP20 4.6 x 145 BK	0.66	60	14.0
10401307	RP20 4.6 x 160 BK	0.66	60	14.6
10401308	RP20 4.6 x 160 BK Screw	0.66	60	18.3
10401853	RP20 4.6 x 160 NK	0.66	60	18.3

RP = paper collated

BeA RapidClip

	Item No.	Description	Fastener Type	Length from - to in mm	Capacity/Pieces	Weight (net)
	12000215	14/32-613	14 16 155	15 - 32	Type 14 110 Type 16/155 102	1.4 kg
	12000344	14/40-723 C Contact Actuation	14 16 155	18 - 40	Type 14 159 Type 16/155 149	2.2 kg
	12000244	T25-155	T	13 - 25	82	2.7 kg



BeA RapidClip

For fastening sinuous spring in seats and upholstered furniture

<p>RapidClip F for maximum spring tension of 22 kg</p>			
<p>RapidClip FW for maximum spring tension of 26 kg for Wood and Metal Frames</p>	<p><i>on wood</i></p>		<p><i>on a metal frame</i></p>
<p>RapidClip FWB for maximum spring tension of 15 kg for Back Springing</p>			
<p>RapidClip HA for maximum spring tension of 30 kg</p>			
<p>RapidClip V for maximum spring tension of more than 30 kg</p>			
<p>RapidClip FG R for maximum spring tension of 45 kg for Wood and Metal Frames</p>			
<p>RapidClip FG for maximum spring tension of 45 kg for Wood and Metal Frames</p>			
<p>RapidClip FG for maximum spring tension of 45 kg</p>			

BeA Bar Code Tools

Item No.	Description	Fastener Type	Length from - to in mm	Capacity/Pieces	Weight (net)
 12200030	Bar code Tool K380/10-400	80/380	10	157	1.8 kg

On request also available for plastic staple P8.

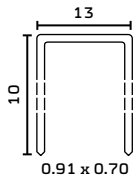

Item No.	Description	Mille/ Carton	Cartons/ Pallet	kg/ Carton
10000741	380/10 NK	144.0	48	19.0

BeA Cable Nailers

Item No.	Description	Fastener Type	Length from - to in mm	Capacity/Pieces	Weight (net)
 12100425	Plastic Washer Stapler 340 C	G4450/25 + Plastic Washer	25	116 Staples + Plastic Washer	2.5 kg

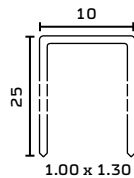

Item No.	Description	Mille/ Box	Mille/ Carton	Cartons/ Pallet	kg/ Carton
10900527	Plastic washers and staples G4450/25 NKH 2.000 Plastic washers and 2 Mille staples	2.0	12.0	40	16.0

BeA Glazier Tools



Item No.	Description	Fastener Type	Length from - to in mm	Capacity/Pieces	Weight (net)
12100197	SK335-201 GL	SK 300	10 - 35	100	0.9 kg

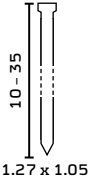

Item No.	Description	Mille/Box	Mille/Carton	Cartons/Pallet	kg/Carton
10300645	SK 325 NK	5	60.0	60	13.7
10300646	SK 330 NK	5	60.0	60	16.1
10300648	SK 335 NK	5	50.0	51	16.0

BeA Deco Nailer



Item No.	Description	Fastener Type	Length from - to in mm	Capacity/Pieces	Weight (net)
12100307	Deco Nailer ZN 100-410	ZN 100 strips	-	60	1.1 kg

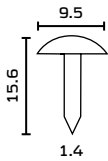



Item No.	Description	Mille/Box	Mille/Carton	Cartons/Pallet	kg/Carton
10700132	ZN 100 (strips) old gold spotted	3	18.0	35	14.3
10700134	ZN 100 (strips) bronze renaissance	3	18.0	35	14.3



BeA Industrial Screwdrivers



	Item No.	Description	Fastener Type	Length from - to in mm	Capacity/ Pieces	Weight (net)
	12600038	SC 55/2500 FC 2.500 RPM	SC	16 - 55	50	1.8 kg
	12600034	SC 55/4000 FC 4.000 RPM	SC	16 - 55	50	1.8 kg
	12600039	SC 75/2500 WS 2.500 RPM	SC	16 - 75	50	2.8 kg
	12600035	SC 55/4000 WS 4.000 RPM	SC	16 - 55	50	2.8 kg
	12600045	SC 75/2500 FT 2.500 RPM	SC	16 - 75	50	1.8 kg

BeA Cordless Screwdriver



	Item No.	Description	Fastener Type	Length from - to in mm	Capacity/ Pieces	Weight (net)
	12600156	SC 55/2-speed 5000/1800 RPM with case	SC	25 - 55	50	2.3 kg
	14509646	Battery 18V. 3.0AH LI-ION-T7				
	14509663	Charger				
	14509661	Bit				



BeA Cordless Screwdriver



Item No.	Description	Fastener Type	Weight (net)
 12600054	Cordless Screwdriver SC/4000 4000 RPM for loose screws with case	SB	1.8 kg

BeA Pneumatic Screwdriver



Item No.	Description	Fastener Type	Weight (net)
 12700063	Air Screwdriver US-LD 50P-05 500 U/m. 12.75 Nm	SB for timber construction	0.9 kg
 12700064	Air Screwdriver US-LD 50P-08 900 U/m. 8.34 Nm	SB e.g. for framing construction	0.9 kg

BeA Bits and Colour Coding for BeFIX Screws

Item No.	Description	Bit. Length. mm	Bit. Colour Coding	Bits Piece/Box	Bits Piece/Carton
14509921	BIT 50 TX15	50	●	5	50
14509922	BIT 50 TX20	50	●	5	50
14509923	BIT 50 TX25	50	●	5	50
14509924	BIT 50 TX30	50	●	5	50
14509925	BIT 50 TX40	50	●	5	50
14509959	BIT 25 TX15	25	●	5	50
14509960	BIT 25 TX20	25	●	5	50
14509961	BIT 25 TX25	25	●	5	50
14509962	BIT 25 TX30	25	●	5	50
14509963	BIT 25 TX40	25	●	5	50
14513461	BIT 25 TX50	25	●	5	50
14509964	BIT holder			1 piece	10 pieces
14509941	BIT BOX TX10-40*	25			



***Contents of the bit box: 31 TX bits and one magnetic Bit holder**

5 x TX 10 white, 5 x TX 15 brown, 5 x TX 20 yellow, 5 x TX 25 blue, 5 x TX 30 red, 6 x TX 40 green, 1 magnetic Bit holder



BeA Collated Screws

Item No.	Description	Mille/Box	Mille/Carton	Carton/Pallet
Drywall Screw. fine thread. for 0.7mm metal studs				
10600212	SC 3.5 x 25*	1.0	10.0	18
10600213	SC 3.5 x 30*	1.0	10.0	18
10600214	SC 3.5 x 35*	1.0	10.0	18
10600215	SC 3.5 x 40*	1.0	10.0	18
10600216	SC 3.5 x 45*	1.0	10.0	18
10600217	SC 3.5 x 55*	0.8	8.0	18



Drywall Screw, Bugle Head, No. 2 Phillips Recess, fine thread, grey phosphated

Drywall Screw. coarse thread. for wooden studs				
10600221	SC 3.9 x 25*	1.0	10.0	18
10600222	SC 3.9 x 30*	1.0	10.0	18
10600273	SC 3.9 x 32*	1.0	10.0	18
10600223	SC 3.9 x 35*	1.0	10.0	18
10600224	SC 3.9 x 40*	1.0	10.0	18
10600225	SC 3.9 x 45*	1.0	10.0	18
10600226	SC 3.9 x 55	0.8	8.0	18
10600312	SC 4.5 x 77	1.0	6.0	18



Drywall Screw, Bugle Head, No. 2 Phillips Recess, coarse thread, grey phosphated

Fibre cement board Screw. fine thread. for 0.7mm metal studs				
10600227	SC 3.9 x 22	1.0	10.0	18
10600228	SC 3.9 x 30	1.0	10.0	18
10600229	SC 3.9 x 35	1.0	10.0	18
10600230	SC 3.9 x 45	1.0	10.0	18



Screw, Small Flat Head with 4 ribs, No. 2 Phillips Recess, fine thread, grey phosphated

Fibre cement board Screw with Tek drilling point for 2 mm metal studs				
10600291	SC 3.5 x 25	1.0	10.0	18



Screw, Small Flat Head with 4 ribs, No. 2 Phillips Recess, Tek thread, drill point, grey phosphated

Drywall Screw with Tek drilling point. fine thread. for 2mm metal studs				
10600232	SC 3.5 x 35	1.0	10.0	18



Self Drilling Screw, Bugle Head, No. 2 Phillips Recess, grey phosphated

Timber Screw. grey phosphated				
10600234	SC 4.2 x 25	1.0	10.0	18
10600236	SC 4.2 x 35	1.0	10.0	18
10600238	SC 4.2 x 45	1.0	10.0	18
10600239	SC 4.2 x 55	1.0	8.0	18



Timber Screw, Small Flat Head with 4 ribs, No. 2 Phillips Recess, 2/3 Hi-Lo thread, diamond point, grey phosphated

Timber Screw. yellow phosphated				
10600240	SC 4.2 x 30	1.0	10.0	18
10600241	SC 4.2 x 35	1.0	10.0	18
10600242	SC 4.2 x 40	1.0	10.0	18
10600243	SC 4.2 x 45	1.0	10.0	18
10600244	SC 4.2 x 55	1.0	8.0	18









Timber Screw, Small Flat Head with 4 ribs, No. 2 Phillips Recess, SS-2/3 Hi-Lo thread, diamond point, yellow zinc phosphated

* Conforms to DIN 18182 and EN 14566. BeA collated screws fit in: Poppers. Prebena. DuraSpin. Senco. Helfer. Fein. Hilti. Makita...
 **Quality is tested in 72 hrs salt spray tests. Supplied in cartons only.



BeA Drywall Screws, Fine thread, loose



Item No.	Description	Pieces/ Box	Pieces/ Carton	kg/Carton
Dry wall screws, Fine thread				
 11200146	SC 3.5 x 25 Gypsum Fine thread PH2 loose*	1.000	12.000	18
 11200147	SC 3.5 x 30 Gypsum Fine thread PH2 loose*	1.000	9.000	14
11200148	SC 3.5 x 35 Gypsum Fine thread PH2 loose*	1.000	9.000	18
11200149	SC 3.5 x 40 Gypsum Fine thread PH2 loose*	750	6.750	12
11200150	SC 3.5 x 45 Gypsum Fine thread PH2 loose*	500	4.500	7
11200151	SC 3.5 x 55 Gypsum Fine thread PH2 loose*	350	3.150	6
*Conforms to DIN 18182 and EN 14566				
Fibre cement board screw with Tek drilling point, fine thread				
 11200152	SC 3.5 x 35 Gypsum Drilling point PH2 loose*	1.000	9.000	18
 11200153	SC 3.5 x 45 Gypsum Drilling point PH2 loose*	500	4.500	10
*Conforms to DIN 18182				
Fibre cement board screw, fine thread, for 0.7 mm metal studs				
 11200154	SC 3.9 x 22 FCB PH2 loose*	1.000	12.000	15
 11200155	SC 3.9 x 30 FCB PH2 loose*	1.000	9.000	11
11200156	SC 3.9 x 45 FCB PH2 loose*	500	4.500	8
Fibre cement board screw with Tek drilling point, fine thread, for 2.0 mm metal studs				
 11200157	SC 3.5 x 25 FCB Drilling point PH2 loose*	1.000	12.000	16



BeA Drywall Screws. Coarse thread, loose



Item No.	Description	Pieces/ Box	Pieces/ Carton	kg/Carton
Dry wall screws, coarse thread, loose, for wooden studs				
 11200158	SC 3.9 x 25 Gypsum Coarse thread PH2 loose*	1.000	12.000	18
11200159	SC 3.9 x 30 Gypsum Coarse thread PH2 loose*	1.000	9.000	16
 11200160	SC 3.9 x 32 Gypsum Coarse thread PH2 loose*	1.000	9.000	17
11200161	SC 3.9 x 35 Gypsum Coarse thread PH2 loose*	1.000	9.000	18
11200162	SC 3.9 x 40 Gypsum Coarse thread PH2 loose*	750	6.750	15
11200163	SC 3.9 x 45 Gypsum Coarse thread PH2 loose*	500	4.500	11
11200164	SC 3.9 x 55 Gypsum Coarse thread PH2 loose*	350	3.150	10
*Conforms to DIN 18182 and EN 14566				

BeA Timber Screws, loose



Item No.	Description	Pieces/ Box	Pieces/ Carton	kg/Carton
Timber Screw, grey phosphated				
 11200165	SC 4.2 x 35 loose*	1.000	9.000	19
 11200166	SC 4.2 x 40 loose*	750	6.750	16
11200167	SC 4.2 x 45 loose*	500	4.500	12
11200168	SC 4.2 x 55 loose*	350	3.150	10
*box includes one PH2 Bit				



BeA BeFIX Screws and BeA

BeFix double threaded screws for builders

Hardened, "blue" zinc plated, free of chrome VI, ETA approved



BeFIX screws are "blue" zinc coated

- free of chrome VI
- higher corrosion resistance than ordinary coatings
- harder surface
- high resistance against wear and tear
- "blue" zinc coated and sealed surface
- approved to service class 1 and 2 according to EN 1995:2008

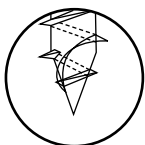

BeFIX screws with aggressive grip-tip

- fast screwing
- less screwing resistance
- ETA approval (European Technical Approval)

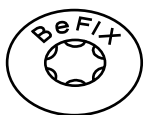

BeFIX screws with proven TX-Bit

- the new conical bit tip fits precisely into the screw head
- the new bit-tip ensures an ideal, non slip traction

Screw dimensions, for example:
BeFIX TK 8.0x300/100/10





BeFIX Chipboard Screws /Wood Construction Screws with countersunk head

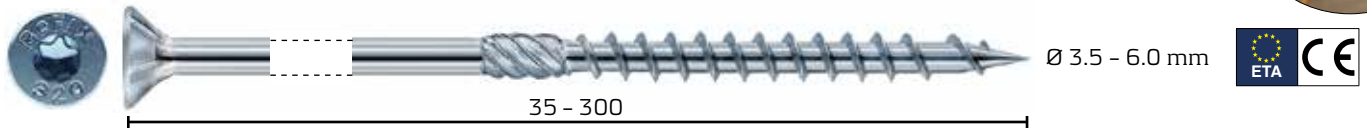

Item No.	Description	Measurements in mm	Bit	Piece/Box	Piece/Carton	kg/Carton
11200087	BeFIX SK 3.5 x 35/21/4 TX15	3.5 x 35	TX 15 ●	1000	12.000	20
11200004	BeFIX SK 3.5 x 40/24/4 TX15	3.5 x 40	TX 15 ●	1000	9.000	16
11200005	BeFIX SK 3.5 x 45/27/4 TX15	3.5 x 45	TX 15 ●	500	6.000	12
11200006	BeFIX SK 3.5 x 50/30/4 TX15	3.5 x 50	TX 15 ●	500	6.000	13
11200007	BeFIX SK 4.0 x 30/18/5 TX20	4.0 x 30	TX 20 ●	1.000	12.000	21
11200008	BeFIX SK 4.0 x 40/24/5 TX20	4.0 x 40	TX 20 ●	1.000	9.000	20
11200009	BeFIX SK 4.0 x 45/27/5 TX20	4.0 x 45	TX 20 ●	500	6.000	15
11200010	BeFIX SK 4.0 x 50/30/5 TX20	4.0 x 50	TX 20 ●	500	6.000	17
11200011	BeFIX SK 4.0 x 60/36/5 TX20	4.0 x 60	TX 20 ●	200	3.600	12
11200012	BeFIX SK 4.0 x 70/42/5 TX20	4.0 x 70	TX 20 ●	200	3.600	14
11200013	BeFIX SK 4.5 x 40/24/7 TX25	4.5 x 40	TX 25 ●	500	9.000	26
11200014	BeFIX SK 4.5 x 50/30/7 TX25	4.5 x 50	TX 25 ●	500	6.000	20
11200015	BeFIX SK 4.5 x 60/36/7 TX25	4.5 x 60	TX 25 ●	200	2.400	10
11200016	BeFIX SK 4.5 x 70/42/7 TX25	4.5 x 70	TX 25 ●	200	2.400	11
11200017	BeFIX SK 4.5 x 80/48/7 TX25	4.5 x 80	TX 25 ●	200	2.400	13
11200018	BeFIX SK 5.0 x 40/24/8 TX25	5.0 x 40	TX 25 ●	200	3.600	14
11200019	BeFIX SK 5.0 x 50/30/8 TX25	5.0 x 50	TX 25 ●	200	3.600	17
11200020	BeFIX SK 5.0 x 60/36/8 TX25	5.0 x 60	TX 25 ●	200	2.400	13
11200021	BeFIX SK 5.0 x 70/42/8 TX25	5.0 x 70	TX 25 ●	200	2.400	15
11200022	BeFIX SK 5.0 x 80/48/8 TX25	5.0 x 80	TX 25 ●	200	2.400	17
11200023	BeFIX SK 5.0 x 90/54/8 TX25	5.0 x 90	TX 25 ●	200	2.400	19
11200024	BeFIX SK 5.0 x 100/60/8 TX25	5.0 x 100	TX 25 ●	200	2.400	21
11200025	BeFIX SK 5.0 x 120/70/8 TX25	5.0 x 120	TX 25 ●	200	2.400	25
11200026	BeFIX SK 6.0 x 60/36/10 TX30	6.0 x 60	TX 30 ●	200	2.400	19
11200027	BeFIX SK 6.0 x 70/42/10 TX30	6.0 x 70	TX 30 ●	200	2.400	22
11200028	BeFIX SK 6.0 x 80/48/10 TX30	6.0 x 80	TX 30 ●	200	2.400	24
11200029	BeFIX SK 6.0 x 90/54/10 TX30	6.0 x 90	TX 30 ●	100	1.800	20
11200030	BeFIX SK 6.0 x 100/60/10 TX30	6.0 x 100	TX 30 ●	100	1.200	15
11200032	BeFIX SK 6.0 x 120/70/10 TX30	6.0 x 120	TX 30 ●	100	1.200	18
11200034	BeFIX SK 6.0 x 140/70/10 TX30	6.0 x 140	TX 30 ●	100	1.200	21
11200036	BeFIX SK 6.0 x 160/70/10 TX30	6.0 x 160	TX 30 ●	100	1.200	23
11200037	BeFIX SK 6.0 x 180/70/10 TX30	6.0 x 180	TX 30 ●	100	900	20
11200038	BeFIX SK 6.0 x 200/70/10 TX30	6.0 x 200	TX 30 ●	100	900	22
11200039	BeFIX SK 6.0 x 220/70/10 TX30	6.0 x 220	TX 30 ●	100	900	23
11200040	BeFIX SK 6.0 x 240/70/10 TX30	6.0 x 240	TX 30 ●	100	600	17
11200088	BeFIX SK 6.0 x 260/70/10 TX30	6.0 x 260	TX 30 ●	100	600	19
11200041	BeFIX SK 6.0 x 280/70/10 TX30	6.0 x 280	TX 30 ●	100	600	20
11200042	BeFIX SK 6.0 x 300/70/10 TX30	6.0 x 300	TX 30 ●	100	600	21

BeFIX Chipboard Screws /Wood Construction Screws with countersunk head



Item No.	Description	Measurements in mm	Bit	Piece/Box	Piece/Carton	kg/Carton
11200043	BeFIX SK 8.0 x 80/50/10 TX40	8.0 x 80	TX 40 ●	50	600	11
11200044	BeFIX SK 8.0 x 100/60/10 TX40	8.0 x 100	TX 40 ●	50	600	14
11200045	BeFIX SK 8.0 x 120/70/10 TX40	8.0 x 120	TX 40 ●	50	600	16
11200046	BeFIX SK 8.0 x 140/80/10 TX40	8.0 x 140	TX 40 ●	50	600	18
11200047	BeFIX SK 8.0 x 160/90/10 TX40	8.0 x 160	TX 40 ●	50	450	16
11200089	BeFIX SK 8.0 x 180/100/10 TX40	8.0 x 180	TX 40 ●	50	450	17
11200048	BeFIX SK 8.0 x 200/100/10 TX40	8.0 x 200	TX 40 ●	50	450	19
11200049	BeFIX SK 8.0 x 220/100/10 TX40	8.0 x 220	TX 40 ●	50	450	21
11200050	BeFIX SK 8.0 x 240/100/10 TX40	8.0 x 240	TX 40 ●	50	450	23
11200051	BeFIX SK 8.0 x 260/100/10 TX40	8.0 x 260	TX 40 ●	50	300	17
11200052	BeFIX SK 8.0 x 280/100/10 TX40	8.0 x 280	TX 40 ●	50	300	18
11200053	BeFIX SK 8.0 x 300/100/10 TX40	8.0 x 300	TX 40 ●	50	300	19
11200054	BeFIX SK 8.0 x 320/100/10 TX40	8.0 x 320	TX 40 ●	50	-	4
11200055	BeFIX SK 8.0 x 340/100/10 TX40	8.0 x 340	TX 40 ●	50	-	4
11200056	BeFIX SK 8.0 x 360/100/10 TX40	8.0 x 360	TX 40 ●	50	-	4
11200057	BeFIX SK 8.0 x 380/100/10 TX40	8.0 x 380	TX 40 ●	50	-	4
11200058	BeFIX SK 8.0 x 400/100/10 TX40	8.0 x 400	TX 40 ●	50	-	5
11200170	BeFIX SK 10.0 x 100/60/10 TX50	10.0 x 100	TX 50 ●	50	-	2
11200171	BeFIX SK 10.0 x 120/70/10 TX50	10.0 x 120	TX 50 ●	50	-	2
11200092	BeFIX SK 10.0 x 140/80/10 TX50	10.0 x 140	TX 50 ●	50	-	2
11200093	BeFIX SK 10.0 x 160/90/10 TX50	10.0 x 160	TX 50 ●	50	-	2
11200094	BeFIX SK 10.0 x 180/100/10 TX50	10.0 x 180	TX 50 ●	50	-	3
11200095	BeFIX SK 10.0 x 200/100/10 TX50	10.0 x 200	TX 50 ●	50	-	3
11200172	BeFIX SK 10.0 x 220/100/10 TX50	10.0 x 220	TX 50 ●	50	-	3
11200173	BeFIX SK 10.0 x 240/100/10 TX50	10.0 x 240	TX 50 ●	50	-	3
11200174	BeFIX SK 10.0 x 260/100/10 TX50	10.0 x 260	TX 50 ●	50	-	4
11200175	BeFIX SK 10.0 x 280/100/10 TX50	10.0 x 280	TX 50 ●	50	-	4
11200096	BeFIX SK 10.0 x 300/100/10 TX50	10.0 x 300	TX 50 ●	50	-	4
11200176	BeFIX SK 10.0 x 320/100/10 TX50	10.0 x 320	TX 50 ●	50	-	5
11200177	BeFIX SK 10.0 x 340/100/10 TX50	10.0 x 340	TX 50 ●	50	-	5
11200097	BeFIX SK 10.0 x 360/100/10 TX50	10.0 x 360	TX 50 ●	50	-	5
11200178	BeFIX SK 10.0 x 380/100/10 TX50	10.0 x 380	TX 50 ●	50	-	6
11200098	BeFIX SK 10.0 x 400/100/10 TX50	10.0 x 400	TX 50 ●	50	-	6



BeFIX Wood Construction Screws with wafer head



Loose Screws



Ø 6.0 - 10.0 mm



Item No.	Description	Measurements in mm	Bit	Piece/Box	Piece/Carton	kg/ Carton
11200059	BeFIX TK 6.0 x 50/30/10 TX30	6.0 x 50	TX 30 ●	100	1.800	12
11200060	BeFIX TK 6.0 x 60/36/10 TX30	6.0 x 60	TX 30 ●	100	1.800	14
11200061	BeFIX TK 6.0 x 70/42/10 TX30	6.0 x 70	TX 30 ●	100	1.800	17
11200062	BeFIX TK 6.0 x 80/48/10 TX30	6.0 x 80	TX 30 ●	100	1.800	19
11200069	BeFIX TK 6.0 x 100/60/10 TX30	6.0 x 100	TX 30 ●	100	1.200	16
11200064	BeFIX TK 6.0 x 120/70/10 TX30	6.0 x 120	TX 30 ●	100	1.200	18
11200065	BeFIX TK 6.0 x 140/70/10 TX30	6.0 x 140	TX 30 ●	100	1.200	21
11200066	BeFIX TK 6.0 x 160/70/10 TX30	6.0 x 160	TX 30 ●	100	1.200	24
11200067	BeFIX TK 6.0 x 180/70/10 TX30	6.0 x 180	TX 30 ●	100	900	20
11200068	BeFIX TK 6.0 x 200/70/10 TX30	6.0 x 200	TX 30 ●	100	900	22
11200070	BeFIX TK 8.0 x 80/50/10 TX40	8.0 x 80	TX 40 ●	50	600	14
11200071	BeFIX TK 8.0 x 100/60/10 TX40	8.0 x 100	TX 40 ●	50	600	16
11200072	BeFIX TK 8.0 x 120/70/10 TX40	8.0 x 120	TX 40 ●	50	600	18
11200073	BeFIX TK 8.0 x 140/80/10 TX40	8.0 x 140	TX 40 ●	50	600	21
11200074	BeFIX TK 8.0 x 160/90/10 TX40	8.0 x 160	TX 40 ●	50	450	17
11200075	BeFIX TK 8.0 x 180/100/10 TX40	8.0 x 180	TX 40 ●	50	450	19
11200076	BeFIX TK 8.0 x 200/100/10 TX40	8.0 x 200	TX 40 ●	50	450	21
11200077	BeFIX TK 8.0 x 220/100/10 TX40	8.0 x 220	TX 40 ●	50	450	23
11200078	BeFIX TK 8.0 x 240/100/10 TX40	8.0 x 240	TX 40 ●	50	300	16
11200079	BeFIX TK 8.0 x 260/100/10 TX40	8.0 x 260	TX 40 ●	50	300	18
11200080	BeFIX TK 8.0 x 280/100/10 TX40	8.0 x 280	TX 40 ●	50	300	19
11200081	BeFIX TK 8.0 x 300/100/10 TX40	8.0 x 300	TX 40 ●	50	300	20
11200082	BeFIX TK 8.0 x 320/100/10 TX40	8.0 x 320	TX 40 ●	-	50	4
11200083	BeFIX TK 8.0 x 340/100/10 TX40	8.0 x 340	TX 40 ●	-	50	4
11200084	BeFIX TK 8.0 x 360/100/10 TX40	8.0 x 360	TX 40 ●	-	50	4
11200085	BeFIX TK 8.0 x 380/100/10 TX40	8.0 x 380	TX 40 ●	-	50	5
11200086	BeFIX TK 8.0 x 400/100/10 TX40	8.0 x 400	TX 40 ●	-	50	5
11200099	BeFIX TK 10.0 x 140/80/10 TX50	10.0 x 140	TX 50 ●	-	50	3
11200100	BeFIX TK 10.0 x 160/90/10 TX50	10.0 x 160	TX 50 ●	-	50	3
11200101	BeFIX TK 10.0 x 180/100/10 TX50	10.0 x 180	TX 50 ●	-	50	3
11200102	BeFIX TK 10.0 x 200/100/10 TX50	10.0 x 200	TX 50 ●	-	50	3
11200103	BeFIX TK 10.0 x 220/100/10 TX50	10.0 x 220	TX 50 ●	-	50	4
11200104	BeFIX TK 10.0 x 240/100/10 TX50	10.0 x 240	TX 50 ●	-	50	4
11200105	BeFIX TK 10.0 x 260/100/10 TX50	10.0 x 260	TX 50 ●	-	50	4
11200106	BeFIX TK 10.0 x 280/100/10 TX50	10.0 x 280	TX 50 ●	-	50	5
11200107	BeFIX TK 10.0 x 300/100/10 TX50	10.0 x 300	TX 50 ●	-	50	5
11200108	BeFIX TK 10.0 x 320/100/10 TX50	10.0 x 320	TX 50 ●	-	50	5
11200109	BeFIX TK 10.0 x 340/100/10 TX50	10.0 x 340	TX 50 ●	-	50	6
11200179	BeFIX TK 10.0 x 360/100/10 TX50	10.0 x 360	TX 50 ●	-	50	6
11200180	BeFIX TK 10.0 x 380/100/10 TX50	10.0 x 380	TX 50 ●	-	50	6
11200110	BeFIX TK 10.0 x 400/100/10 TX50	10.0 x 400	TX 50 ●	-	50	7

BeFIX Double Thread Screws for above rafter insulation



Item No.	Description	Measurements in mm	Bit	Piece/Box	Piece/Carton	kg/Carton
11200182	BeFIX ZYKD 8.0x165 TX40	8.0x165	TX 40 ●	50	450	17
11200183	BeFIX ZYKD 8.0x195 TX40	8.0x195	TX 40 ●	50	450	20
11200184	BeFIX ZYKD 8.0x225 TX40	8.0x225	TX 40 ●	50	450	23
11200185	BeFIX ZYKD 8.0x235 TX40	8.0x235	TX 40 ●	50	300	16
11200186	BeFIX ZYKD 8.0x255 TX40	8.0x255	TX 40 ●	50	300	18
11200187	BeFIX ZYKD 8.0x275 TX40	8.0x275	TX 40 ●	50	300	19
11200188	BeFIX ZYKD 8.0x302 TX40	8.0x302	TX 40 ●	50	-	4

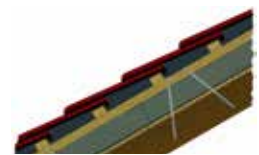

BeA Anchor Screw for timber connectors

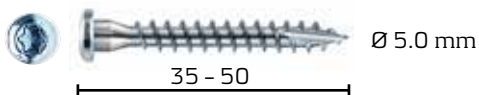

Item No.	Description	Measurements in mm	Bit	Piece/Box	Piece/Carton	kg/Carton
11200001	BeFIX HVV 5.0 x 35 TX20	5.0 x 35	TX 20 ●	250	4.500	15
11200002	BeFIX HVV 5.0 x 40 TX20	5.0 x 40	TX 20 ●	250	4.500	17
11200003	BeFIX HVV 5.0 x 50 TX20	5.0 x 50	TX 20 ●	250	4.500	20

BeA Bits

Item No.	Description	Bit length. mm	Bit Colour	Bit Coding	Bits Piece/Box	Bits Piece/Carton
14509921	BIT 50 TX15	50	●		5	50
14509922	BIT 50 TX20	50	●		5	50
14509923	BIT 50 TX25	50	●		5	50
14509924	BIT 50 TX30	50	●		5	50
14509925	BIT 50 TX40	50	●		5	50
14509959	BIT 25 TX15	25	●		5	50
14509960	BIT 25 TX20	25	●		5	50
14509961	BIT 25 TX25	25	●		5	50
14509962	BIT 25 TX30	25	●		5	50
14509963	BIT 25 TX40	25	●		5	50
14513461	BIT 25 TX50	25	●		5	50
14509964	BIT Holder				1 Piece	10 Piece
14509941	BIT BOX TX10-40*	25				

*Contents of the bit box: 31 TX bits and one magnetic Bit holder

5 x TX 10 white, 5 x TX 15 brown, 5 x TX 20 yellow, 5 x TX 25 blue, 5 x TX 30 red, 6 x TX 40 green, 1 magnetic Bit holder

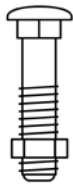

Item No.	Description	Piece/ Carton	Piece/ Pallet	kg/ Carton
DIN 603. 4.8, Cup head square neck bolt with nut, electro galvanized				
11200531	FRS M 8 x 30 NK DIN 603	200	19.200	4.6
11200532	FRS M 8 x 35 NK DIN 603	200	19.200	4.9
11200533	FRS M 8 x 40 NK DIN 603	200	19.200	5.4
11200564	FRS M 8 x 45 NK DIN 603	200	19.200	5.8
11200536	FRS M 8 x 50 NK DIN 603	200	19.200	6.0
11200413	FRS M 8 x 60 NK DIN 603	200	19.200	6.8
11200323	FRS M 8 x 70 NK DIN 603	100	22.000	3.8
11200508	FRS M 8 x 780 NK DIN 603	100	9.000	4.3
11200565	FRS M 8 x 790 NK DIN 603	100	9.000	4.8
11200324	FRS M 8 x 100 NK DIN 603	100	14.400	5.0
11200325	FRS M10 x 80 NK DIN 603	100	14.400	6.8
11200326	FRS M10 x 100 NK DIN 603	100	11.000	8.1
11200510	FRS M10 x 120 NK DIN 603	50	10.000	5.2
11200486	FRS M10 x 140 NK DIN 603	50	10.000	7.7
11200534	FRS M12 x 50 NK DIN 603	100	5.500	5.2
11200567	FRS M12 x 60 NK DIN 603	100	5.500	6.2
11200568	FRS M12 x 70 NK DIN 603	100	5.500	7.2
11200327	FRS M12 x 80 NK DIN 603	50	7.200	5.2
11200328	FRS M12 x 110 NK DIN 603	50	5.500	6.5
11200329	FRS M12 x 120 NK DIN 603	50	5.500	7.0
11200330	FRS M12 x 130 NK DIN 603	50	5.500	7.4
11200202	FRS M12 x 140 NK DIN 603	50	5.500	7.1
11200203	FRS M12 x 150 NK DIN 603	50	5.500	7.5
11200204	FRS M12 x 160 NK DIN 603	25	5.000	3.9
11200205	FRS M12 x 180 NK DIN 603	25	4.500	4.3
11200206	FRS M12 x 190 NK DIN 603	25	4.200	4.4
11200207	FRS M12 x 200 NK DIN 603	25	4.350	4.6
11200208	FRS M12 x 210 NK DIN 603	25	3.800	4.8
11200209	FRS M12 x 220 NK DIN 603	25	3.750	5.0
11200210	FRS M12 x 240 NK DIN 603	25	3.500	5.3
11200211	FRS M12 x 250 NK DIN 603	25	3.500	5.5
11200212	FRS M12 x 260 NK DIN 603	25	3.350	5.7
11200214	FRS M12 x 270 NK DIN 603	25	3.300	5.8
11200215	FRS M12 x 280 NK DIN 603	25	3.000	6.0
11200216	FRS M12 x 290 NK DIN 603	25	3.000	6.2
11200217	FRS M12 x 300 NK DIN 603	25	3.000	6.3
11200611	FRS M12 x 320 NK DIN 603	25	3.000	6.7
11200219	FRS M12 x 340 NK DIN 603	25	2.500	7.0
11200220	FRS M12 x 360 NK DIN 603	25	2.400	7.4
11200221	FRS M12 x 380 NK DIN 603	25	2.400	7.7
11200480	FRS M12 x 400 NK DIN 603	25	2.400	8.1
11200535	FRS M12 x 420 NK DIN 603	25	2.400	8.5
11200481	FRS M12 x 460 NK DIN 603	25	2.400	9.3
11200418	FRS M16 x 140 NK DIN 603	25	2.500	7.5
11200506	FRS M16 x 150 NK DIN 603	25	4.000	7.7
11200419	FRS M16 x 160 NK DIN 603	25	2.500	7.9

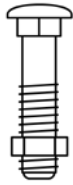
BeA  for Export and Professional Packaging

Item No.	Description	Piece/ Carton	Piece/ Pallet	kg/ Carton
DIN 603. 4.8, Cup head square neck bolt with nut, electro galvanized				
11200222	FRS M16 x 180 NK DIN 603	25	2.500	8.1
11200223	FRS M16 x 200 NK DIN 603	25	2.400	8.8
11200224	FRS M16 x 220 NK DIN 603	25	2.200	9.4
11200225	FRS M16 x 240 NK DIN 603	25	2.000	10.0
11200226	FRS M16 x 260 NK DIN 603	25	2.000	10.6
11200227	FRS M16 x 280 NK DIN 603	25	1.800	11.3
11200228	FRS M16 x 300 NK DIN 603	25	1.800	11.9
11200229	FRS M16 x 320 NK DIN 603	25	1.700	12.5
11200230	FRS M16 x 340 NK DIN 603	25	1.600	13.1
11200231	FRS M16 x 360 NK DIN 603	25	1.500	13.8
11200232	FRS M16 x 380 NK DIN 603	25	1.400	14.4
11200233	FRS M16 x 400 NK DIN 603	25	1.350	15.0
11200234	FRS M16 x 420 NK DIN 603	15	1.300	9.4
11200235	FRS M16 x 440 NK DIN 603	15	1.250	9.8
11200236	FRS M16 x 460 NK DIN 603	15	1.200	10.1
11200237	FRS M16 x 480 NK DIN 603	15	1.200	10.5
11200238	FRS M16 x 500 NK DIN 603	15	1.200	10.9
11200239	FRS M16 x 520 NK DIN 603	15	1.005	11.3
11200240	FRS M16 x 580 NK DIN 603	15	1.005	12.4
11200241	FRS M16 x 620 NK DIN 603	15	900	13.1
11200242	FRS M20 x 360 NK DIN 603	15	1.000	17.0
11200243	FRS M20 x 380 NK DIN 603	15	1.000	17.8
11200244	FRS M20 x 400 NK DIN 603	20	920	18.6
11200245	FRS M20 x 420 NK DIN 603	20	900	19.5
11200246	FRS M20 x 440 NK DIN 603	20	800	20.3
11200247	FRS M20 x 460 NK DIN 603	20	800	21.1

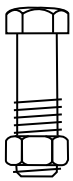

Item No.	Description	Piece/ Carton	Piece/ Pallet	kg/ Carton
DIN 601, Hexagon head bolt with nut, electro galvanized				
11200540	SKSM M12 x 180 NK DIN 601	25	800	4.7
11200477	SKSM M12 x 500 NK DIN 601	25	800	12.5
11200498	SKSM M24 x 200 NK DIN 601	10	1.000	9.8



Item No.	Description	Piece/ Carton	Piece/ Pallet	kg/ Carton
DIN 976. 4.8, Thread rod, electro galvanized				
11200400	GWS M10 x 1000 NK	25	2.000	12.3
11200248	GWS M12 x 480 NK	20	3.000	6.9
11200249	GWS M12 x 530 NK	20	2.500	7.6
11200250	GWS M12 x 1000 NK	20	1.500	14.3
11200251	GWS M12 x 1250 NK	20	1.000	17.9
11200252	GWS M16 x 1000 NK	10	800	13.1
11200253	GWS M16 x 1250 NK	10	600	16.4
11200254	GWS M16 x 1500 NK	10	500	19.7
11200255	GWS M16 x 2000 NK	10	400	26.2
11200256	GWS M20 x 1000 NK	10	500	20.5
11200258	GWS M20 x 1500 NK	10	300	30.8
11200475	GWS M20 x 2000 NK	10	300	35.0
11200261	GWS M24 x 1000 NK	5	350	14.2
11200383	GWS M24 x 2000 NK	5	350	28.4
11200259	GWS M30 x 1000 NK	5	200	23.4



Item No.	Description	Piece/ Carton	kg/ Carton
Hexagon connecting sleeve, electro galvanized			
11200394	VBM-SK M 8 x 30 SW 13	100	2.4
11200395	VBM-SK M10 x 30 SW 17	50	2.1
11200334	VBM-SK M16 x 50 SW 24	25	3.1
11200335	VBM-SK M20 x 50 SW 30	25	4.8
11200336	VBM-SK M24 x 50 SW 36	25	6.9
11200337	VBM-SK M30 x 60 SW 46	25	13.5

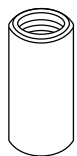

Item No.	Description	Piece/ Carton	kg/ Carton
Round connecting sleeve, electro galvanized			
11200338	VBM-RD M12 x 40 DRM 15 mm	100	2.4
11200339	VBM-RD M16 x 50 DRM 22 mm	25	1.9



Item No.	Description	Piece/ Carton	Piece/ Pallet	kg/ Carton
DIN 934-8, Hexagon nut, electro galvanized				
11200396	SK-nut M 8 NK DIN 934	1.000	144.000	4.8
11200397	SK-nut M10 NK DIN 934	500	72.000	4.6
11200267	SK-nut M12 NK DIN 934	250	45.000	3.7
11200268	SK-nut M16 NK DIN 934	200	21.600	6.2
11200269	SK-nut M20 NK DIN 934	100	10.800	4.6
11200398	SK-nut M24 NK DIN 934	50	7.200	4.6
11200399	SK-nut M30 NK DIN 934	25	2.700	6.2

 for Export and Professional Packaging



Item No.	Description	Pieces/ Box	Piece/ Carton	Piece/ Pallet	kg/ Carton
DIN 582, Eye nut, electro galvanized					
11200408	RM M10 NK DIN 582 C15E CE	-	100	5.000	17.0
11200262	RM M12 NK DIN 582 C15E CE	5	50	4.800	13.0
11200263	RM M16 NK DIN 582 C15E CE	5	50	3.000	13.0
11200264	RM M20 NK DIN 582 C15E CE	5	40	2.000	16.0
11200265	RM M24 NK DIN 582 C15E CE	5	20	900	15.0



Item No.	Description	Pieces/ Box	Piece/ Carton	Piece/ Pallet	kg/ Carton
DIN 580, Lifting eye bolt, electro galvanized					
11200569	RS M 8 NK DIN 580 C15E CE	-	25	3.000	2.0
11200570	RS M10 NK DIN 580 C15E CE	-	25	3.000	3.2
11200438	RS M12 NK DIN 580 C15E CE	-	10	3.000	2.7
11200266	RS M16 NK DIN 580 C15E CE	5	50	3.000	15.0
11200571	RS M20 NK DIN 580 C15E CE	-	15	3.000	4.9



Item No.	Description	Piece/ Carton	kg/ Carton
DIN 741, Wire rope clamp, electro galvanized			
11200332	DSK M10 NK DIN 741*)	25	3.3

*) Wire robe Ø 1.3mm



Item No.	Description	Piece/ Carton	Piece/ Pallet	kg/ Carton
DIN 436, Square washer with round hole, electro galvanized				
11200309	SCH M12 40 x 40 x 13.5 x 4 NK DIN 436	100	14.000	4.6
11200310	SCH M16 50 x 50 x 17.5 x 5 NK DIN 436	100	8.600	8.9
11200311	SCH M20 60 x 60 x 22.0 x 5 NK DIN 436	50	4.300	6.3
11200390	SCH M24 80 x 80 x 26.0 x 6 NK DIN 436	25	2.150	6.9
11200391	SCH M30 95 x 95 x 33.0 x 6 NK DIN 436	25	2.150	9.6



Item No.	Description	Piece/ Carton	Piece/ Pallet	kg/ Carton
DIN 440R, Washer with round hole, electro galvanized				
11200387	SCH M 6 22 x 6.6 x 2 NK DIN 440R	200	115.200	1.1
11200388	SCH M 8 28 x 9.0 x 3 NK DIN 440R	200	54.400	2.6
11200389	SCH M10 34 x 11.0 x 3 NK DIN 440R	200	37.200	3.8
11200603	SCH M10 34 x 11.0 x 4 NK DIN 440R	250	100.000	4.9
11200314	SCH M12 44 x 13.5 x 4 NK DIN 440R	200	17.200	8.7
11200315	SCH M16 56 x 17.5 x 5 NK DIN 440R	100	8.600	9.7
11200392	SCH M20 72 x 22.0 x 6 NK DIN 440R	50	4.300	8.7
11200393	SCH M24 85 x 26.0 x 6 NK DIN 440R	25	2.150	6.1



Item No.	Description	Piece/ Carton	Piece/ Pallet	kg/ Carton
DIN 440V, Washer with square hole, electro galvanized				
11200320	SCH M12 44 x 14 x 14 x 4 NK DIN 440V	200	28.000	8.6
11200321	SCH M16 58 x 18 x 18 x 5 NK DIN 440V	100	8.600	8.7
11200322	SCH M20 68 x 22 x 22 x 5 NK DIN 440V	50	4.300	8.7



Item No.	Description	Piece/ Carton	Piece/ Pallet	kg/ Carton
DIN 9021, Washer with round hole, electro galvanized, HV 100				
11200316	SCH M 6 18 x 6.4 x 1.6 NK DIN 9021	200	115.200	0.6
11200384	SCH M 8 24 x 8.4 x 2.0 NK DIN 9021	200	76.800	1.2
11200385	SCH M10 30 x 10.5 x 2.5 NK DIN 9021	200	54.400	2.4
11200317	SCH M12 37 x 13.0 x 3.0 NK DIN 9021	100	18.600	2.2
11200318	SCH M16 50 x 17.0 x 3.0 NK DIN 9021	100	14.000	4.1
11200319	SCH M20 60 x 22.0 x 4.0 NK DIN 9021	100	8.600	7.7



Item No.	Description	Piece/ Carton	Piece/ Pallet	kg/ Carton
DIN 571, Hexagon head wood screw, electro galvanized				
11200273	SK-HS 6 x 60 NK DIN 571	200	57.600	2.2
11200274	SK-HS 6 x 80 NK DIN 571	200	57.600	2.9
11200275	SK-HS 8 x 50 NK DIN 571	200	36.000	3.6
11200276	SK-HS 8 x 60 NK DIN 571	200	28.800	4.2
11200631	SK-HS 8 x 80 NK DIN 571	100	21.600	3.0
11200278	SK-HS 8 x 100 NK DIN 571	100	21.600	3.2
11200279	SK-HS 8 x 160 NK DIN 571	50	14.400	2.5
11200280	SK-HS 8 x 180 NK DIN 571	50	10.800	2.7
11200281	SK-HS 8 x 200 NK DIN 571	50	10.800	3.2
11200282	SK-HS 8 x 220 NK DIN 571	50	5.000	3.3
11200283	SK-HS 8 x 240 NK DIN 571	50	5.000	3.7
11200284	SK-HS 8 x 260 NK DIN 571	25	5.000	2.0
11200285	SK-HS 8 x 280 NK DIN 571	25	5.000	2.2
11200286	SK-HS 10 x 60 NK DIN 571	100	18.000	3.7
11200287	SK-HS 10 x 70 NK DIN 571	100	14.400	4.1
11200288	SK-HS 10 x 80 NK DIN 571	100	14.400	4.5
11200289	SK-HS 10 x 100 NK DIN 571	100	10.800	5.4
11200290	SK-HS 10 x 120 NK DIN 571	50	10.800	3.1
11200291	SK-HS 10 x 140 NK DIN 571	50	9.000	3.6
11200292	SK-HS 10 x 150 NK DIN 571	50	9.000	3.7
11200293	SK-HS 10 x 160 NK DIN 571	25	7.200	2.0
11200294	SK-HS 10 x 180 NK DIN 571	25	7.200	2.2
11200471	SK-HS 10 x 200 NK DIN 571	50	5.500	5.1
11200512	SK-HS 10 x 220 NK DIN 571	50	7.200	6.5
11200513	SK-HS 10 x 240 NK DIN 571	50	7.200	7.9
11200295	SK-HS 12 x 60 NK DIN 571	100	10.800	5.2
11200296	SK-HS 12 x 70 NK DIN 571	50	10.800	2.7
11200297	SK-HS 12 x 80 NK DIN 571	50	10.800	3.9
11200298	SK-HS 12 x 100 NK DIN 571	50	9.000	3.2
11200299	SK-HS 12 x 120 NK DIN 571	50	7.200	4.5
11200300	SK-HS 12 x 140 NK DIN 571	50	5.400	5.1
11200301	SK-HS 12 x 160 NK DIN 571	25	5.400	3.1
11200302	SK-HS 12 x 180 NK DIN 571	25	4.500	3.4
11200414	SK-HS 12 x 200 NK DIN 571	25	3.600	3.6
11200415	SK-HS 12 x 220 NK DIN 571	25	3.600	3.8
11200416	SK-HS 12 x 240 NK DIN 571	25	3.600	4.0
11200417	SK-HS 12 x 260 NK DIN 571	25	3.600	4.2

BeA  for Export and Professional Packaging



Item No.	Description	Piece/ Carton	Piece/ Pallet	kg/ Carton
DIN 571, Hexagon head wood screw, electro galvanized				
11200303	SK-HS 16 x 120 NK DIN 571	25	3.600	4.1
11200304	SK-HS 16 x 140 NK DIN 571	25	3.600	4.7
11200305	SK-HS 16 x 160 NK DIN 571	25	3.600	5.3
11200306	SK-HS 16 x 180 NK DIN 571	25	3.600	5.8
11200307	SK-HS 16 x 200 NK DIN 571	25	2.700	7.0
11200308	SK-HS 16 x 220 NK DIN 571	25	2.160	7.2



Item No.	Description	Piece/ Carton	Piece/ Pallet	kg/ Carton
Chipboard screw, TX head, electro galvanized				
11200340	SPS 3.0 x 16 NK TX 10	1000	1.080.000	0.6
11200341	SPS 3.0 x 20 NK TX 10	1000	1.080.000	0.7
11200342	SPS 3.0 x 25 NK TX 10	1000	540.000	0.9
11200343	SPS 3.0 x 30 NK TX 10	1000	360.000	1.0
11200344	SPS 3.5 x 16 NK TX 15	1000	540.000	0.8
11200345	SPS 3.5 x 25 NK TX 15	1000	360.000	1.1
11200346	SPS 3.5 x 30 NK TX 15	1000	360.000	1.3
11200347	SPS 3.5 x 35 NK TX 15	1000	270.000	1.6
11200348	SPS 3.5 x 50 NK TX 15	500	180.000	1.1
11200349	SPS 4.0 x 16 NK TX 20	1000	540.000	1.1
11200350	SPS 4.0 x 20 NK TX 20	1000	360.000	1.3
11200351	SPS 4.0 x 25 NK TX 20	1000	360.000	1.6
11200352	SPS 4.0 x 30 NK TX 20	1000	360.000	1.8
11200353	SPS 4.0 x 35 NK TX 20	1000	270.000	2.1
11200354	SPS 4.0 x 40 NK TX 20	1000	180.000	2.3
11200355	SPS 4.0 x 45 NK TX 20	500	135.000	1.2
11200356	SPS 4.0 x 50 NK TX 20	500	135.000	1.3
11200357	SPS 4.0 x 60 NK TX 20	500	135.000	1.6
11200358	SPS 4.0 x 70 NK TX 20	200	72.000	0.7
11200581	SPS 5.0 x 20 NK TX 20	1000	180.000	3.3
11200466	SPS 5.0 x 30 NK TX 25	500	180.000	1.8
11200382	SPS 5.0 x 35 NK TX 25	500	180.000	1.6
11200359	SPS 5.0 x 40 NK TX 25	500	135.000	1.8
11200360	SPS 5.0 x 50 NK TX 25	500	135.000	2.2
11200444	SPS 5.0 x 55 NK TX 25	500	90.000	2.3
11200361	SPS 5.0 x 60 NK TX 25	200	54.000	1.0
11200362	SPS 5.0 x 70 NK TX 25	200	54.000	1.2
11200363	SPS 5.0 x 80 NK TX 25	200	54.000	1.3
11200364	SPS 5.0 x 90 NK TX 25	200	54.000	1.5
11200365	SPS 5.0 x 100 NK TX 25	200	54.000	1.6
11200366	SPS 5.0 x 120 NK TX 25	100	54.000	1.0
11200367	SPS 6.0 x 30 NK TX 30	500	180.000	2.2
11200368	SPS 6.0 x 40 NK TX 30	200	90.000	1.1
11200369	SPS 6.0 x 50 NK TX 30	200	72.000	1.3
11200370	SPS 6.0 x 60 NK TX 30	200	54.000	1.5
11200371	SPS 6.0 x 70 NK TX 30	200	54.000	1.7

Item No.	Description	Piece/ Carton	Piece/ Pallet	kg/ Carton
Chipboard screw, TX head, electro galvanized				
11200372	SPS 6.0 x 80 NK TX 30	200	54.000	2.0
11200373	SPS 6.0 x 90 NK TX 30	100	54.000	1.1
11200612	SPS 6.0 x 100 NK TX 30	200	30.000	2.5
11200375	SPS 6.0 x 120 NK TX 30	100	27.000	1.4
11200376	SPS 6.0 x 140 NK TX 30	100	27.000	1.6
11200377	SPS 6.0 x 160 NK TX 30	100	27.000	1.9
11200378	SPS 6.0 x 180 NK TX 30	100	18.000	2.1
11200379	SPS 6.0 x 200 NK TX 30	100	18.000	2.3

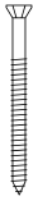

Item No.	Description	Pieces/ Box	Piece/ Carton	Piece/ Pallet	kg/ Carton
Anchor nail, loose, electro galvanized					
20100192	6.0 x 60	250	1.000	40.000	13.4
20100181	6.0 x 80	250	1.000	40.000	17.8
20100193	6.0 x 100	250	1.000	40.000	22.3



Item No.	Description	kg/ Carton	Carton/ Pallet	kg/ Pallet
Wire nails, loose, steel bright				
15200472	2.5 x 50	2.5	400	1.000
15200474	2.5 x 56	2.5	400	1.000
15200168	3.1 x 80	5.0	200	1.000
15201198	4.0 x 100	5.0	200	1.000
15201199	4.5 x 130	5.0	200	1.000
15201200	5.6 x 160	5.0	200	1.000
15201201	6.3 x 180	5.0	200	1.000
15201202	7.1 x 210	5.0	200	1.000



Item No.	Description	kg/ Carton	Carton/ Pallet	kg/ Pallet
DuoFIX Hexagon Screw with TX-Head				
11200489	DuoFIX SK 10 x 100 NK TX	600	19.200	17.5
11200490	DuoFIX SK 10 x 120 NK TX	600	19.200	19.5
11200491	DuoFIX SK 10 x 140 NK TX	400	12.800	13.5
11200492	DuoFIX SK 10 x 160 NK TX	400	12.800	15.1
11200493	DuoFIX SK 10 x 200 NK TX	400	12.800	18.7
11200494	DuoFIX SK 10 x 240 NK TX	400	12.800	21.4
11200495	DuoFIX SK 10 x 300 NK TX	400	9.600	24.7



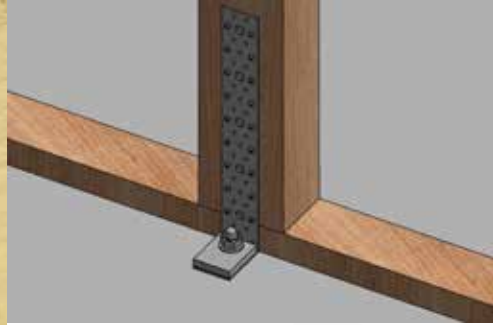

CE

New

BeA expansion fasteners BeCoFix

Range

No.	Type	M thread	Total length (L) in mm	Max. thickness piece to be affixed (t _{fix}) in mm	Ø max. piece to be affixed (d _f) in mm	Anchorage depth (h _{ef}) in mm	Marking	Qty / Box
10900569	M6x65	6	65	15	7	35	CA 15	150
10900570	M6x85		85	35	7	35	CA 35	100
10900572	M8x65	8	65	7	9	40	CA 7	100
10900573	M8x75		75	15	9	40	CA 15	100
10900574	M8x90		90	30	9	40	CA 30	60
10900575	M8x115		115	55	9	40	CA 55	50
10900576	M8x135		135	75	9	40	CA 75	40
10900577	M10x75	10	75	5	12	50	CA 5	50
10900578	M10x90		90	20	12	50	CA 20	40
10900579	M10x120		120	50	12	50	CA 50	40
10900581	M10x145		145	70	12	50	CA 70	40
10900582	M10x170		170	100	12	50	CA 100	40
10900589	M10x210	210	140	12	50	CA 140	25	
10900583	M12x100	12	100	10	14	60	CA 10	40
10900580	M12x110		110	20	14	60	CA 20	40
10900584	M12x135		135	45	14	60	CA 45	30
10900585	M12x160		160	70	14	60	CA 70	30
10900590	M12x185		185	100	14	60	CA 100	25
10900591	M12x200	200	115	14	60	CA 115	25	
10900586	M16x125	16	125	10	18	85	CA 10	20
10900587	M16x145		145	30	18	85	CA 30	20
10900588	M16x175		175	60	18	85	CA 60	15

Material: Galvanised steel type SWRCH35K meets JIS G 3507-1 (2005)
 European Technical Assessment: ETA No.15/0842
 Fire resistance: Class A1
 Intended use: Uncracked concrete types C20/25 to C50/60.



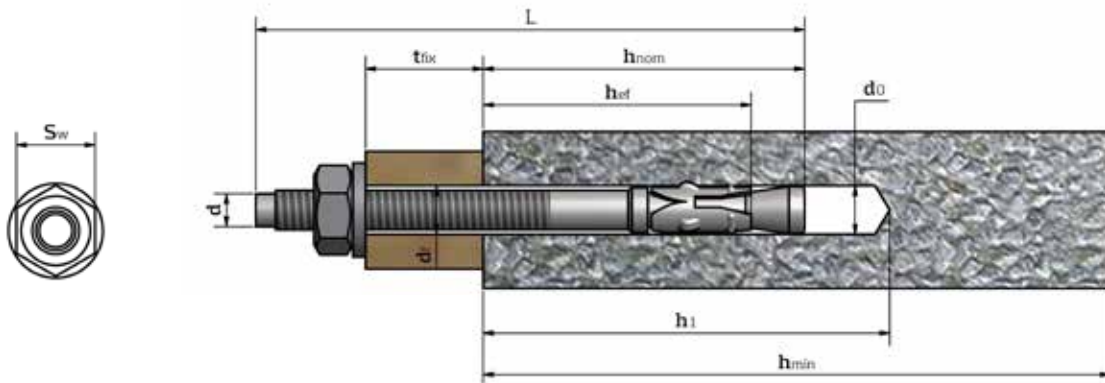

- t_{fix} = Max. thickness of item to be affixed
- L = Length of anchor shaft
- d_o = Drill hole diameter
- h₁ = Min. depth of drill hole in member
- h_{nom} = Min. effective depth
- h_{ef} = Effective anchorage depth
- h_{min} = Min. member thickness
- d_f = Diameter of insertion hole
- S_w = Wrench opening width
- T_{inst} = Required tightening torque



BeA Timber Connectors

	Description	Dimensions / Materials / Applications
	<p>Joist Hangers Legs inside and outside</p>	<ul style="list-style-type: none"> - Available in different sizes - Galvanized Steel Plates - For fixing beams
	<p>Angle Brackets</p>	<ul style="list-style-type: none"> - Available in different sizes - Galvanized Steel Plates - For fixing trimmed joist to timber
	<p>Roof Ridge Fixing</p>	<ul style="list-style-type: none"> - Available in lengths 160 - 370 mm - Galvanized Steel Plates - Used in roof frames and for cross beams
	<p>Perforated Plates</p>	<ul style="list-style-type: none"> - Available in different sizes - Galvanized Steel Plates - Used mainly in beam and roof constructions
	<p>Truss Brace</p>	<ul style="list-style-type: none"> - Available in different sizes - Galvanized Steel Plates - Used for stabilizing timber constructions
	<p>True Shoe Wood and Concrete</p>	<ul style="list-style-type: none"> - Available in type H for wood and type B for concrete - Hot Dipped Galvanized Steel Plates
	<p>Loose Nails</p>	<ul style="list-style-type: none"> - Available in lengths 80 - 330 mm - For roof trusses
	<p>HVV Anchor Nails</p>	<ul style="list-style-type: none"> - Available in lengths 35 - 100 mm. Ø 4.0 mm - For fastening HVV Timber Connectors



BeA Timber Connectors

	Description	Dimensions / Materials / Applications
	Gusset Plates	<ul style="list-style-type: none"> - Available in lengths 90. 130. 170 and 210 mm - Galvanized Steel Plates - Used for anchoring timber when fixing roofing sheets
	Angled Lugs	<ul style="list-style-type: none"> - Available in different sizes - Steel Plate. Hot galvanised after punching - Used for fixing wood to concrete
	T Anchor Plates	<ul style="list-style-type: none"> - Available in lengths 160. 180 and 200 mm - Galvanized Steel Plates - For simple fixing of a T Girder to timber
	Column Shoes	<ul style="list-style-type: none"> - Available in different types and sizes - Hot dipped galvanized after welding - Used for casting in concrete when fixing posts





BeA supplies a wide variety of timber connectors. Please contact us for an individual offer and further information.

BeA Hotmelt Technology

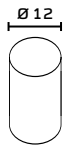
	Item No.	Description	Fastener Type	Capacity/ Pieces	Weight (net)
	12500148	BeA 225	Sticks Ø 12 mm	1 Stick	0.3 kg
	12500191	BeA 295 Adjustable temperature from 130° - 200°C	Sticks Ø 12 mm	1 Stick	0.8 kg



Item No.	Description	Carton/ Pallet	kg/ Carton
11800220	HM 505/12	36	10.0
11800221	HM 535/12	35	10.0
11800222	HM 665/12	35	10.0

	Item No.	Description	Fastener Type	Capacity/ Pieces	Weight (net)
	12500186	BeA 315 with digital temperature control	Sticks Ø 43 mm	2 Sticks	1.2 kg
	12500077	BeA 321 Glue is dispensed by a pneumatic piston	Sticks Ø 43 mm	2 Sticks	1.5 kg
	12500078	BeA 351 For spray application	Sticks Ø 43 mm	2 Sticks	1.4 kg
	14000159	Pressure regulator			

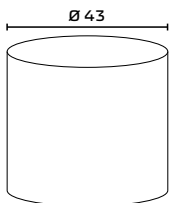

Item No.	Description	Carton/ Pallet	kg/ Carton
11800074	HM 502/43	36	10.0
11800075	HM 532/43	36	10.0
11800077	HM 640/43	36	10.0
11800078	HM 642/43	36	10.0
11800080	HM 660/43	36	10.0
11800070	SP 420/43	10.0	36.0
11800072	SP 431/43	10.0	36.0
11800261	SP 435/43 for concrete applications	10.0	36.0



HOTMELT STICKS - Ø 12 mm and 43 mm

Hotmelt, Basis E Ethylenglycolacetat (EVA)	Available in Ø mm	Colour	Open Time ^{*1}	Softening Point ^{*2}	Heat Resistance ^{*3}	Low Temperature Flexibility ^{*4}	
HM 501	12; 43	pale amber	15 s	106° C	65° C		
HM 502	43	light brown	10 s	100° C	85° C		
HM 505	12	clear transparent	10 s	105° C ^{*6}	60° C ^{*7}	X	
HM 532	43	clear transparent	15 s	86° C	75° C	X	
HM 535	12	clear transparent	25 s	95° C ^{*6}	60° C ^{*7}	X	
HM 542	43	ivory	5 s	104° C	75° C		
HM 640	12; 43	clear transparent	45 s	84° C	75° C	X	
HM 642	12	brown	40 s	90° C	80° C		
HM 642	43	brown	40 s	90° C	70° C		
HM 660	12	pale amber	40 s	87° C	70° C		
HM 660	43	pale amber	30 s	85° C	70° C	X	
HM 665	12	yellow	35 s	88° C ^{*6}	55° C ^{*7}		
Spray Hotmelt Basis Polyolefin	Available in Ø mm	Colour	Open Time ^{*1}	Softening Point ^{*2}	Heat Resistance ^{*3}	Low Temperature Flexibility ^{*4}	
SP 410	43	pale amber	1 Min.	125° C	80° C	X	
SP 420	43	pale amber	3 Min.	105° C	85° C		
SP 431	43	pale amber	6 Min.	105° C	80° C		
SP 435	43	pale amber	3 Min.	105° C	80° C		

^{*1)} BS5350 H4

^{*2)} ASTM E28

^{*3)} BS 5350 H3

^{*4)} flexible up to -20 °C

^{*5)} ASTM D3236

Further hotmelts are available on request. Customers own tests are recommended.

Viscosity 180° cps ^{*5}	Characteristics	Typical Applications
2.000	relative short open time, good adhesion to many surfaces	Porous materials e.g. paper, wood, textile, foams, packaging
4.500	short open time, very high molten tack	Packaging
5000 ^{*8}	short open time, very high molten tack	Packaging
9.500	transparent, good adhesion to many surfaces, high viscosity and excellent gap filling, middle open time	General purpose adhesive (paper, wood, textile, foam)
20000 ^{*8}	transparent, good adhesion to many surfaces, high viscosity and excellent gap filling, middle open time	General purpose adhesive (paper, wood, textile, foam)
9.500	very short open time	Packaging
5.500	transparent, long open time, good adhesion to many surfaces	General purpose adhesive (textile, wood, plastics), excellent performance
5.500	transparent, long open time, good adhesion to many surfaces	General purpose adhesive (textile, wood, plastics as polyamide, polystrol etc.)
3.500	transparent, long open time, good adhesion to many surfaces	General purpose adhesive (textile, wood, plastics as polyamide, polystrol etc.)
6.800	forms a tough, but flexible bond, long open time, for general materials	General materials (metal, glass, plastics, ceramics, fibreglass, paper and board)
1.950	forms a tough, but flexible bond, long open time, for general materials	General materials (metal, glass, plastics, ceramics, fibreglass, paper and board)
5.000 ^{*8}	forms a tough, but flexible bond, long open time, for general materials	General materials (metal, glass, plastics, ceramics, fibreglass, paper and board)

Viscosity 180° cps ^{*5}	Characteristics	Typical Applications
3.200	Suitable for spraying and bead applications, excellent low temperature flexibility	Pallet stabilising, packaging
4.500	Formulated for spraying, long open time, good adhesion to many surfaces	Packaging foams, formed mouldings, upholstery foams, most plastics
4.000	Formulated for spraying, very long open time, good adhesion to many surfaces, tough shock resistant bond	Most plastics, foams, wood and cardboard
2.500	Formulated for spraying, very long open time, good adhesion to many surfaces, tough shock resistant bond	Wood, plastic and metal. Special developed for the concrete industry

*6) following DIN 52011

*7) WPS 68

*8) following DIN 53211

BeA Compressors

Description	Item No.		Weight (net)			
 Compressor K 160-6	12400086		9 kg			
	Volume/ min	Outcome Volume	Max. pressure	Capacity	Voltage	Engine power
	160 l/min	65 l/min	8 bar	6 Liter	220 V	1.1 kW

Description	Item No.		Weight (net)			
 Compressor K 192-10	12400087		25 kg			
	Volume/ min	Outcome Volume	Max. pressure	Capacity	Voltage	Engine power
	190 l/min	100 l/min	8 bar	10 Liter	220 V	1.1 kW

Description	Item No.		Weight (net)			
 Compressor K 270 - 20 oil free	12400123		45 kg			
	Volume/ min	Outcome Volume	Max. pressure	Capacity	Voltage	Engine power
	265 l/min	160 l/min	10 bar	20 Liter	220 V	1.8 kW

Description	Item No.		Weight (net)			
 Compressor KV 350-15	12400093		50 kg			
	Volume/ min	Outcome Volume	Max. pressure	Capacity	Voltage	Engine power
	350 l/min	240 l/min	10 bar	15 Liter	220 V	2.2 kW

Description	Item No.	Weight (net)
 Hose drum 30 m inner diameter 8.5 mm	14000406	9 kg

BeA Power Packages

BeA Power Package (K160 Kit) comprising:



Compressor K160-6

+



Spiral Hose

+



Blow Gun

+



Stapler of your choice (see below)

Item No.	Description	Weight
12100493	KIT K160 with 380/16-420 (Tool description Page 29)	14 kg
12100495	KIT K160 with 380/16-429LN (Tool description Page 29)	14 kg
12100497	KIT K160 with 90/40-621 (Tool description Page 34)	14 kg
12100498	KIT K160 with KIT 229 (Tool description Page 49)	14 kg
12100499	KIT K160 with SKAM 350-226C (Tool description Page 54)	14 kg
12100491	KIT K160 with SKAM 450-227C (Tool description Page 55)	14 kg
12100500	KIT K160 with SKS 650-228 (Tool description Page 56)	14 kg



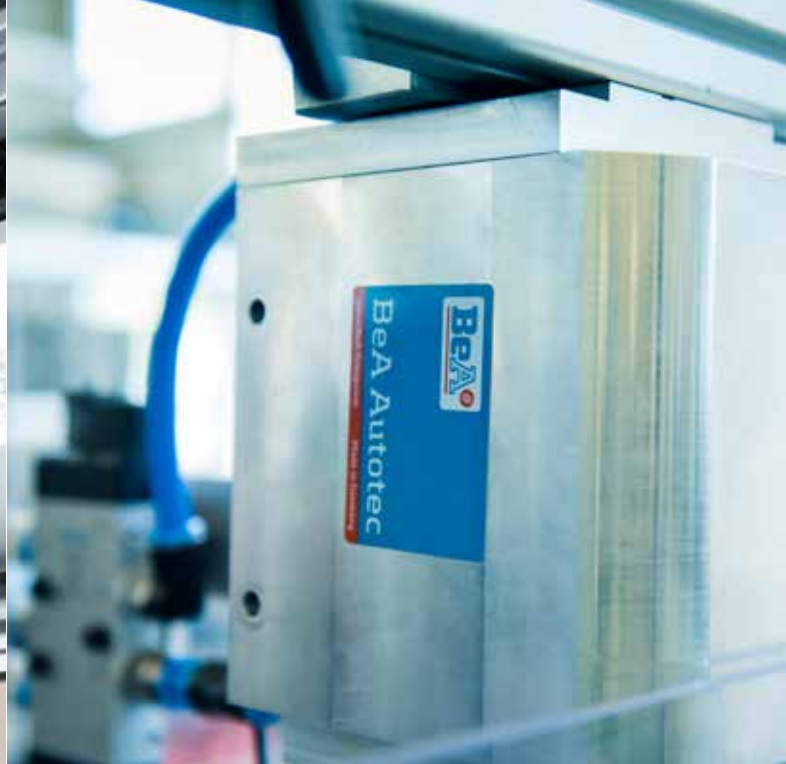

BeA Autotec

The BeA Autotec system offers the following benefits:

- Precision German manufactured equipment that guarantees performance reliability.
- Automated staple signal input, either 24V DC or pneumatic
- Individual energy adjustment of the stapler head to the specific application

- Wide array of accessories, including electronic placement and magazine control, edge guides, rollers, etc.
- Reduces your manufacturing costs through
 - Customized design
 - Installation into new or existing equipment
 - Availability of customized components and accessories for tool mounting and fastener application



BeA Autotec tool - long magazine 235 / 245 / 265 / 285
Magazine capacity: 100 - 500 fasteners (approx.) leg lengths: 4 - 200 mm

- Placement and stapling possible in any position and orientation
- Various leg lengths can be loaded without further adjustments
- Electronic placement and magazine control
- High speed fastening - frequency up to 8 cycles per second
- Multiple mounting options facilitate installation

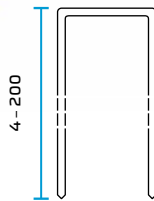

Applications:

prefabricated houses, window and door frames, packaging, furniture, pallets and crates



BeA Autotec tool strip nailer
Magazine capacity: up to 140 nails leg lengths: 50 - 100 mm

- Adjustable magazine capacity
- Electronic placement and magazine control
- Low maintenance
- Long operating life

Applications:

prefabricated houses, furniture frames, pallets and crates

ROUND HEAD NAILS

Nails	Magazine capacity	Frequency/sec.	Air consumption
Ø 2.8 - 4.1 / 50 - 100 mm	120 Nails	max 4 - 5 /sec	3.5 - 4 Litre at 6 bar

D-HEAD NAILS

Nails	Magazine capacity	Frequency/sec.	Air consumption
Ø 2.9 - 3.4 / 50 - 100 mm	160 Nails	max 4 - 5 /sec	3.5 - 4 Litre at 6 bar



R20

Overview of BeA fasteners:

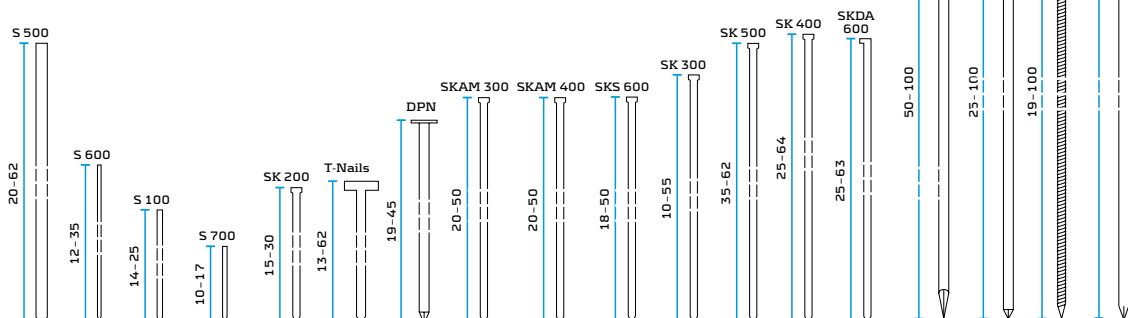



New

BeA Autotec strip nailer 296 with reloading station 297

for strip nails type R20 in lengths 130 - 160 mm Ø 3.8 - 5.0 mm

BeA Autotec strip nailer 296

- Magazine capacity of 2 nail strips
- Magazine control
- "Dry firing" control
- Multi directional nailing possible

Reloading station 297 with automatic nail feeding

- Reloading and feeding of the nails happens automatically using a cassette type holding bay for 90 nail strips (approx. 1.800 nails)
- Filling of the nail cassette (straight out of the carton) takes little time
- The loading station automatically corrects the position of the nail strip and feeds it correctly into the magazine of the nailer

Applications:

crating, heavy duty wooden packaging (pallets etc.) and prefabricated house industry



Description	Length in mm
R20 3.8 x 130 BK	130
R20 3.8 x 130 BK Screw	130
R20 3.8 x 130 BK Ring	130
R20 3.8 x 130 NK	130
R20 4.2 x 130 BK	130
R20 4.2 x 160 BK	160
R20 4.6 x 145 BK	145
R20 4.6 x 160 BK	160
R20 4.6 x 160 BK Screw	160
R20 4.6 x 160 NK	160



BeA Autotec tool for jumbo coils

Magazine capacity: up to 900 nails

Plastic and Wire collated

Nail lengths: 45 - 90 mm

- High magazine capacity
- Electronic placement and magazine control
- Accurate nail placement
- Low maintenance
- Long operating life

Applications:

prefabricated houses, furniture frames, pallets and crates



BDC NAILS

Nails	Magazine capacity	Frequency/sec.	Air consumption
Ø 2.5 - 3.4 / 45 - 90mm	1 jumbo coil / 750 - 900 Nails	max 4 - 5 /sec	2.5 - 4 Litre at 6 bar

TC NAILS

Nails	Magazine capacity	Frequency/sec.	Air consumption
Ø 2.5 - 3.1 / 45 - 90mm	1 jumbo coil / 750 - 900 Nails	max 4 - 5 /sec	2.5 - 4 Litre at 6 bar

BeA Autotec tool side-loader 232 / 242 / 262 / 282

Magazine capacity: up to 5.000 fasteners

Leg lengths: 4 - 130 mm

- High magazine capacity
- Automatic reloading - avoid time intensive manual reloading
- Electronic placement and magazine control
- Frequency up to 8 cycles per second
- Multiple mounting options facilitate installation

Applications:

prefabricated houses, furniture, packaging, pallets and crates

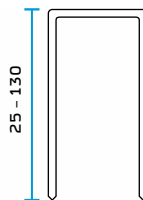
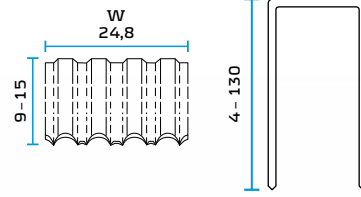

- Increase of output
- Decrease of manufacturing costs
- Higher quality level
- High flexibility
- Increased productivity
- Reduced changeover times
- Low maintenance

BeA Autotec tool with changeover cassette 264 / 284

Magazine capacity: up to 2.300 staples

Leg lengths: 25 - 130 mm

- Compact design
- High speed reloading
- Low maintenance
- Long operating life
- Frequency up to 10 cycles per second
- Electronic placement and magazine control

Applications:

specifically designed for in plant house manufacturing

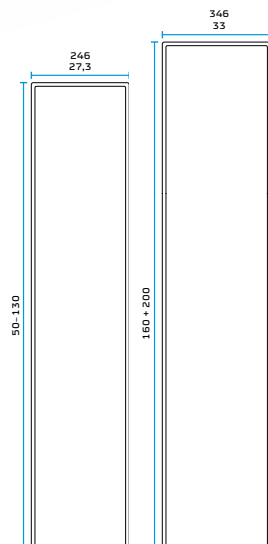
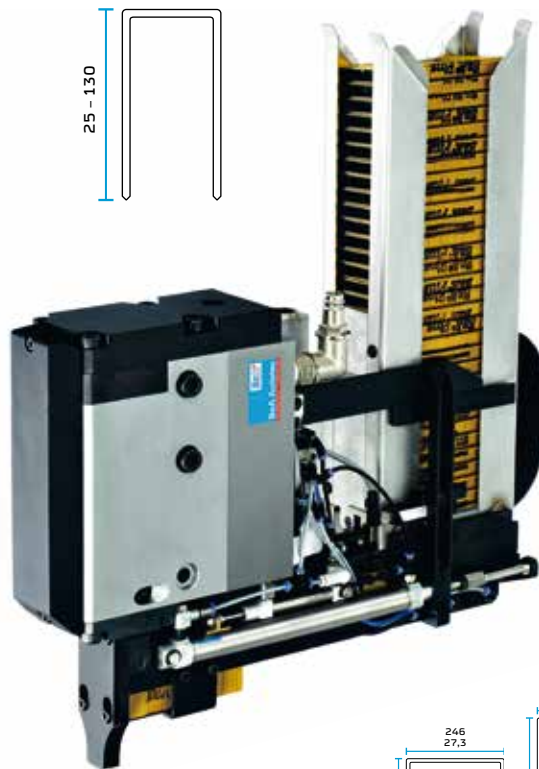

Overview of BeA fasteners:

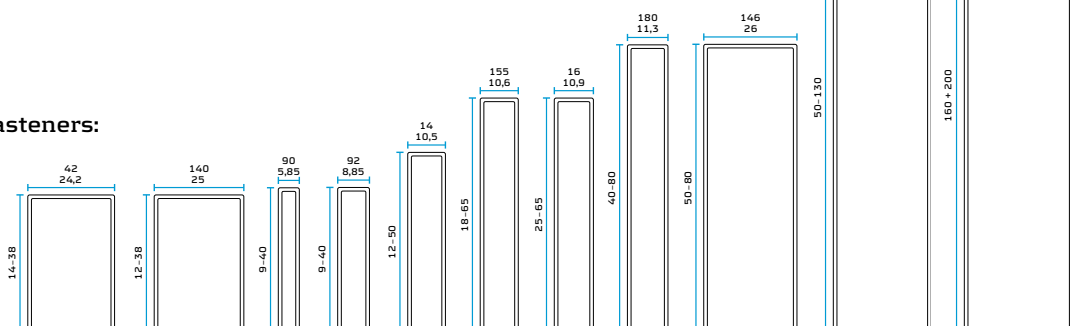

BeA Automated Fastening Systems – highlights

- 1989 first BeA Autotec tool
- 1999 first BeA Autotec tool with changeover cassette
- 2003 first BeA Autotec tool for wide-crown staples
- 2014 first BeA Autotec tool for staples with a diameter of 3.0 mm
- 2015 first automatic reloading station for 20 degree strip nails used in a robotic Autotec strip nailer solution
- 2018 first BeA Autotec "Pusher" which allows an extremely precise adjustment of nail depth

BeA Autotec tool top-loader 230 / 240 / 260 / 280

Magazine capacity: up to 10.000 fasteners
Leg lengths: 4 – 65 mm

- High magazine capacity
- Minimal reloading time
- Electronic placement and magazine control
- Frequency up to 8 cycles per second
- Multiple mounting options facilitate installation

Applications:

prefabricated houses, furniture, packaging, pallets and crates

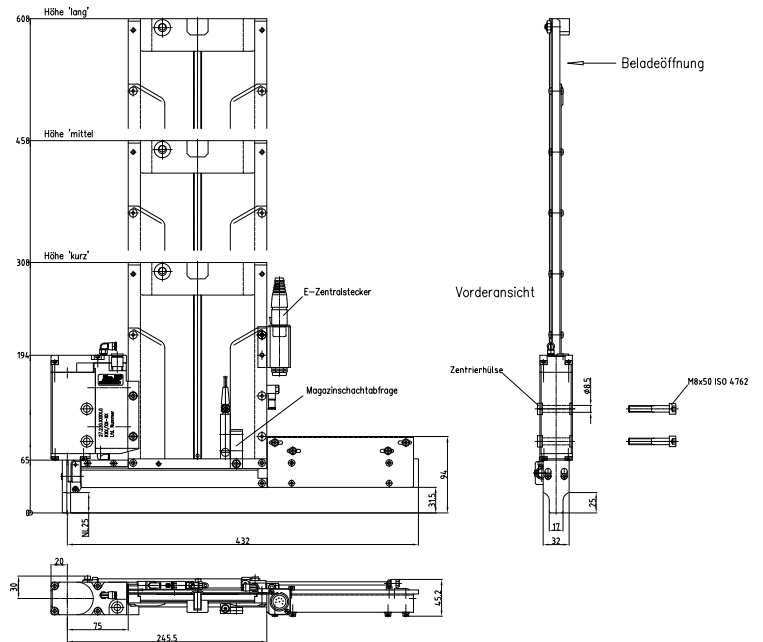
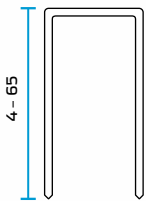
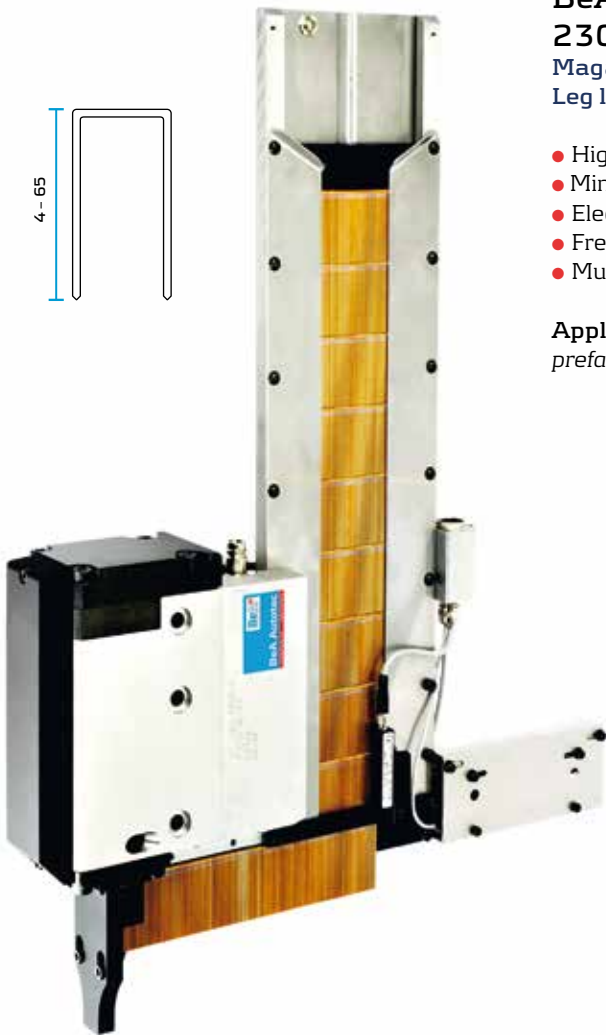

BeA Automated Fastening Systems offer a comprehensive line of products, systems and solutions – customized to your manufacturing requirements. Popular applications include furniture, modular and prefabricated houses, packaging, wood to wood and automobile components.

Overview of BeA fasteners:

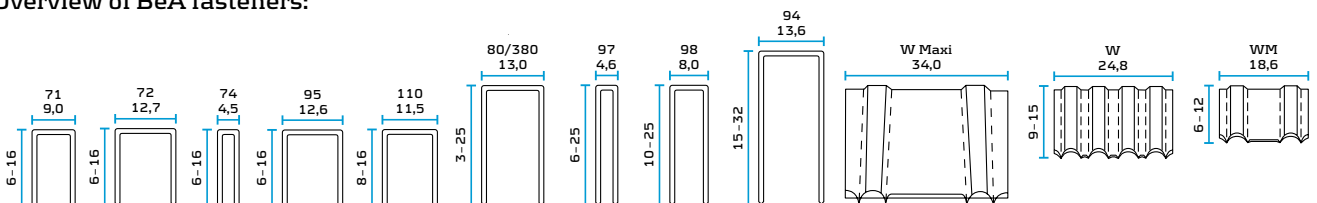

BeA Autotec Pusher for 0° TCIN-Nails

Ø 2.1 - 2.8

L: 35 - 50 mm

Head-Ø: max 6.2 mm

- Elevation adjustment up to 30 mm
- Pre-set penetration depth +/- 2 mm
- Optimal nailing performance
- Fast pushing technology, >2 nails/sec
- Noise reduction
- Jumbo coil magazine
- Nail guide ensures 90° nail position while pushing

Applications::

Applications where flush nail drives are needed: Fire protection boards, plaster, gypsum boards and facades



NAILS 0° TCIN

Nails	Magazine capacity	Frequency	Compression force
Ø 2.1 - 2.8 mm	1 Jumbo Coil	max 2 /sec	350 - 500 kg



BeA Autotec 246/284 SL

For 246 Staples, L: 100 - 160 mm, Crown-Width: 27.3 mm

- Insulation and ETICS installation
- Fasten boards up to 130 mm
- Enhanced productivity and quality
- Up to 3 cycles per second
- Minimized change over and reload times with high capacity cassette magazine

Applications::

Insulation fixing in timber frame fabrication wood fibre and polystyrol boards <130 mm

STAPLES 246

Length	Magazine type	Frequency/Sec
100 - 160 mm	Cassette	max 3 /sec

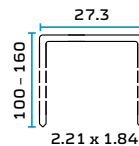

BeA Autotec 346/284 SL for insulation fixing in automated panel and element production

- Insulation and ETICS installation
- Fasten boards up to 160 mm
- Enhanced productivity and quality
- Up to 2 cycles per second
- Minimized change over and reload times with high capacity cassette magazine

Applications::

Insulation fixing in timber frame fabrication wood fibre <160 mm

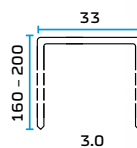

STAPLES 346

Length	Magazine type	Frequency/Sec
160 - 200 mm	Cassette	max 2 /sec



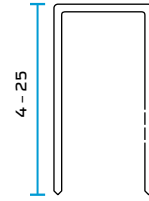

**BeA Autotec tool –
Long magazine unit**

Magazine capacity: 300 – 500 staples
Leg lengths: 4 – 25 mm

Stationary unit, available in automatic or foot-pedal actuation
Hands free operation facilitates proper feeding and alignment

- Contact actuation
- Foot pedal actuation
- Available as double clinching unit

Applications:
*packaging, blister packaging,
low volume assembly*

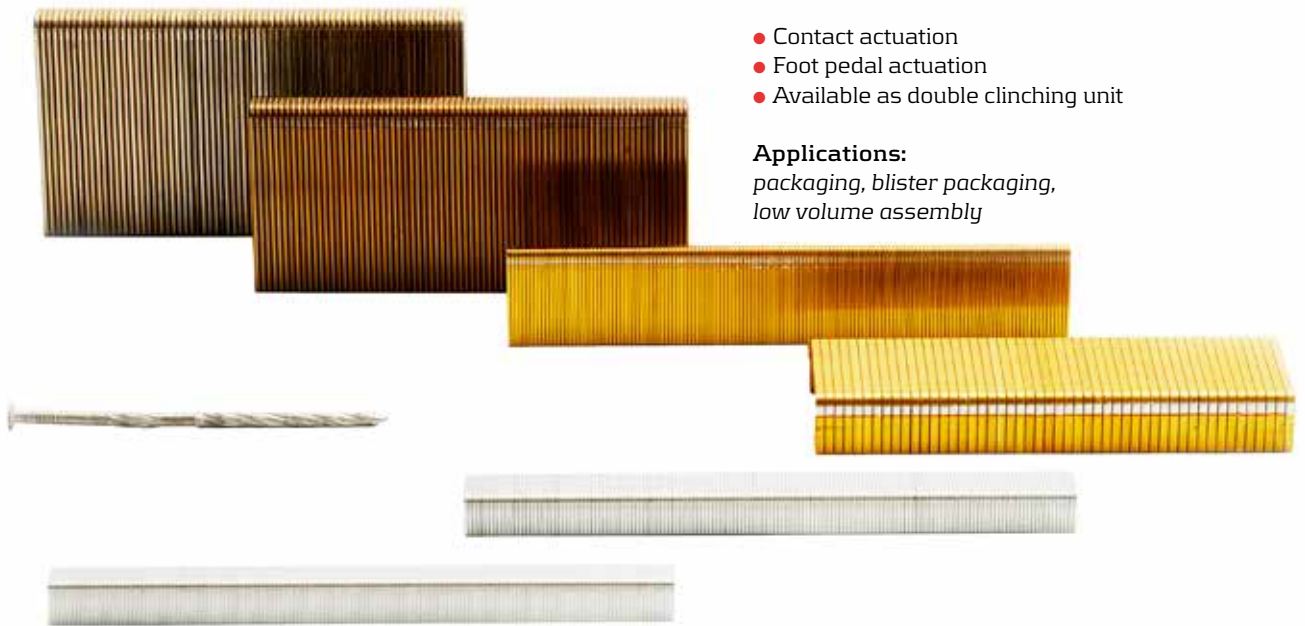

BeA Skater 800C for Coil Nails

Magazine capacity up to 300 nails, type BDC,
in lengths of 60 – 70 mm, Ø 2.5 – 3.1 mm



**BeA Skater 14/65-830C and BeA Skater
180/65-835C for heavy duty staples**

Magazine capacity up to 152 Staples for
fastener type 16/155/180 in lengths 40 – 65 mm

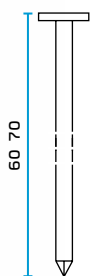

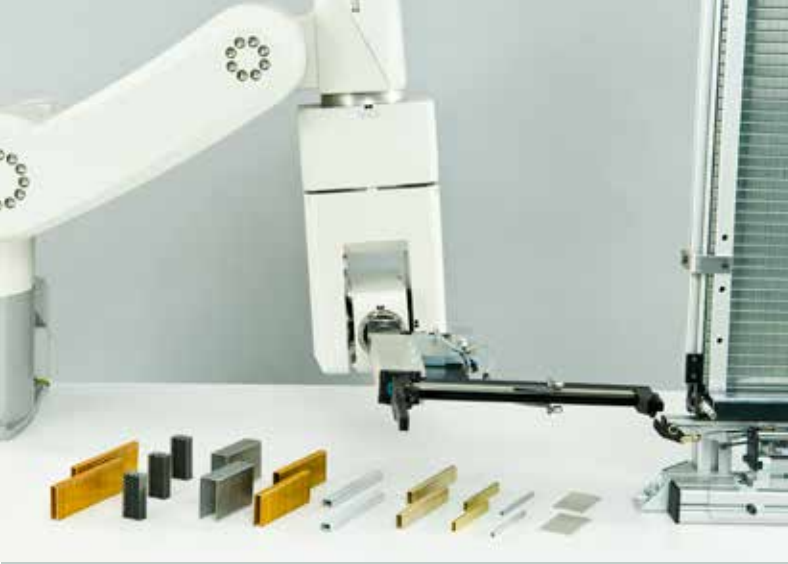

BeA robot reloading system

Magazine capacity up to 30.000 fasteners in lengths ranging from 8 - 65 mm

Please request additional information for specific fasteners.

BeA robot nailer with reloading station

For staples and pins

Incorporates fully automated production processes by being mounted on either multi axis robots or X/Y/Z linear units.

- Small dimensions and low weight (4.5 lbs.) accommodate easy handling and high process speeds. The automatic reloading feature minimizes the tool's weight by carrying only the necessary amount of fasteners per cycle
- Placement and stapling possible in any position and orientation
- Very high capacity of the stationary reloading unit (up to 30.000)

Applications:

Furniture industry, automotive, moulds for sand casting, specialty crate manufacturing

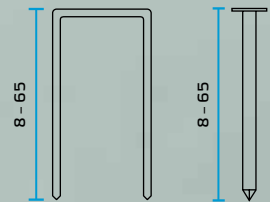

BeA Automated Fastening Systems - reaching beyond standard solutions

Magazine Selection for BeA Autotec

The selection of the magazine depends on:

- type and available space within the mounting system



Stapling station integrated in production line

- type of magazine required



- stapling direction

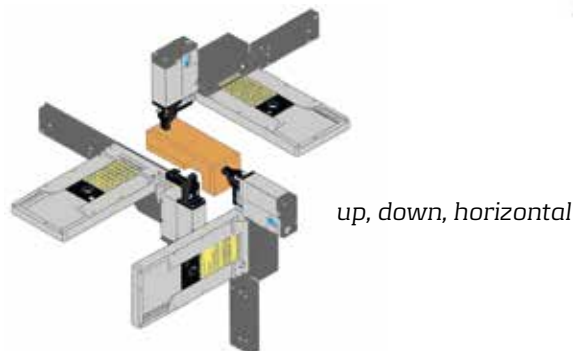

- available space for reloading

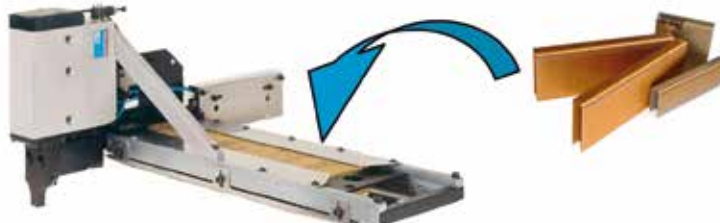

Selection of nose length

The nose length depends on the height of the workpiece

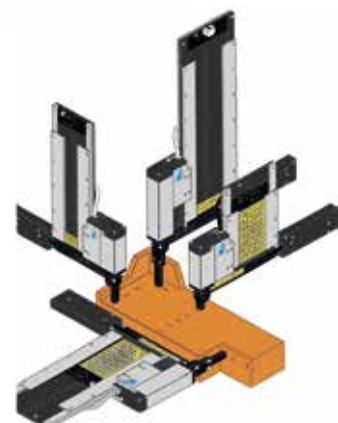

Magazine types



Long Magazine



Side Loader



Top Loader



Changeover Cassette



Self Reloading System



Reloading Station

Please contact our experts with any questions you may have or to enquire about our extensive product range:
+49(0)4102 78 445

BeA automatic fastening solutions for pallets and crates







BeA nailing tools and nailing units

- Automated machines for packing and much more
- CNC controlled machines
- Automation of assembly processes of crates, pallets and other wooden packaging
- Automation of assembly processes of pre-fabricated wooden crates, fences and garden furniture
- Extremely flexible due to supplemental tools, e.g. driller, moulding cutter or saw

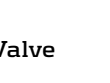

BeA Compressed Air Accessories

Description	Item No.	Min. order quantity
Single handed couplings		
 1/4" A Brass OD	14000256	5
 3/8" A Brass OD	14000224	5
 1/2" A Brass OD	14000226	5
 1/4" I Brass OD	14000198	5
 3/8" I Brass OD	14000199	5
 1/2" I Brass OD	14000232	5

Single handed couplings with hose fitting



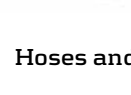

 6 mm LW Brass	14000234	5
 9 mm LW Brass	14000236	5
 13 mm LW Brass	14000238	5

Valve

 Valve 3/8" I with 2 couplings	14000200	-
 Valve 3/8" I with 3 couplings	14000201	-

Hoses and Accessories

 Spiral hose 6 mm I, 7.5 m	14000042	-
 Spiral hose 8 mm I, 7.5 m	14000043	-
 Spiral hose 5 mm I, 7.5 m	14000045	-
 Spiral hose 6.3 mm I, 7.5 m	14000046	-
 Spiral hose 8 mm I, 7.5 m	14000047	-
 PVC Hose 6 mm I, 12 mm A, roll 50 m	14000202	-
 PVC Hose 9 mm I, 15 mm A, roll 50 m	14000204	-
 PVC Hose 12 mm I, 20 mm A, roll 50 m	14000203	-
 Air hose complete. 9 mm I, 15 mm A, 15 m	14000051	-
 30 m Hose drum 8.5 mm inner width	14000406	-

Description	Item No.	Min. order quantity
Hose clamps		
 Clamps for hose 11 - 13 mm OD	14000052	10
 Clamps for hose 13 - 15 mm OD	14000053	10
 Clamps for hose 15 - 17 mm OD	14000054	10
 Screw clamps for hose 10 - 16 mm OD	14000055	10
 Screw clamps for hose 12 - 20 mm OD	14000056	10
 Screw clamps for hose 16 - 25 mm OD	14000057	10
 Screw clamps for hose 20 - 32 mm OD	14000058	10



Teflon sealing tape

 12 mm wide, 12 m long	13301438	-
--	----------	---



Screw lockings

 Adhesive and sealing compound 50 ml	14000060	-
---	----------	---



Grease

 O Ring grease 500 ml	14001362	-
 Frost resistant oil, 1000ml	14000197	-









Plastic blow gun

 1/4" Short nozzle	14000365	-
 1/4" Balancer with extension tube	14000366	-

Balancer

 Lifting capacity 1.0 - 2.0 kg	13301431	-
 Lifting capacity 2.0 - 4.5 kg	13301433	-
 Lifting capacity 6.0 - 8.0 kg	1301435	-



BeA Compressed Air Accessories

Description	Item No.	Min. order quantity
Maintenance units, block assembly		
 Maintenance unit 1/4"	14000150	-
 Maintenance unit 1/2"	14000152	-
 Pressure regulator 1/4"	14000156	-
 Pressure regulator 1/2"	14000158	-
 Pressure regulator 1/4"	14000159	-
 Pressure regulator 1/2"	14000161	-
 Filter air dryer 1/4"	14000162	-
 Lubricator 1/4"	14000165	-
 Lubricator 1/2"	14000167	-



Manometer for maintenance units

 40 mm G 1/8"	14000168	-
50 mm G 1/4"	14000170	-

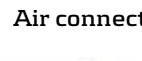
Air connector

 6 mm inner width brass	14000183	5
 9 mm inner width brass	14000184	5
 13 mm inner width brass	14000185	5

Air connector



 1/4" outer diameter steel	14000248	5
 3/8" outer diameter steel	14000249	5

Ball fitting





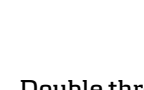

 1/4" steel	14000505	5
--	----------	---

Screw in hose fittings



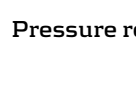

 1/4" G, 6 mm inner width brass	14000187	5
 1/4" G, 9 mm inner width brass	14000188	5
 1/2" G, 13 mm inner width brass	14000191	5

Description	Item No.	Min. order quantity
Polyamide gaskets		
 1/8" G, 10 mm I, 15 mm OD	14000192	10
 1/4" G, 13 mm I, 18.5 mm OD	14400063	10
 3/8" G, 17 mm I, 22 mm OD	14000194	10

Double thread nipple, cylindrical

 1/8" A, 1/4" A, 17 SW, MS	14000061	5
 1/4" A, 1/4" A, 17 SW, MS	14000062	5
 1/4" A, 3/8" A, 19 SW, MS	14000063	5
 3/8" A, 1/2" A, 24 SW, MS	14000064	5
 1/2" A, 1/2" A, 24 SW, MS	14000065	5
 1/4" A, 1/8" A, 17 SW, MS	14000066	5
 3/8" A, 1/4" A, 19 SW, MS	14000067	5
 1/2" A, 3/8" A, 22 SW, MS	14000068	5

Pressure reduction valve 3/8" with deairing

 Reduction to 6 bar	14001504	-
 Reduction to 8 bar	14001573	-
 Additional parts for 3/8"	13300854	-
 Additional parts for 1/4"	14000063 + 14000464	-

General Terms and Conditions of Business

The following General Terms and Conditions of Business (T&Cs) of Joh. Friedrich Behrens AG (hereinafter referred to as the "**Supplier**") form part of the agreement by mutual consent; they take precedence over any deviating terms set by the buyer (hereinafter referred to as the "**Customer**" or "**Buyer**"). This shall also apply if the Supplier provides services which deviate from the General Terms and Conditions of the Customer.

Terms and Conditions of Sale and Delivery

1. Order placement

- 1.1 An agreement shall only enter into effect upon written confirmation by the Supplier or upon execution of an order. Changes, additions and subsidiary agreements to the contract must be made in writing. This shall also apply to this clause.
- 1.2 The Buyer is liable for the accuracy of all documents provided by him, in particular for any drawings, instructions and samples. The Buyer must notify the Supplier of any obvious defects by providing measurements and calculations in good time prior to implementing the order. The Supplier is not obliged to examine the item.
- 1.3 Samples will be provided at additional cost unless otherwise agreed.
- 1.4 Figures, drawings, images and service descriptions provided in brochures, catalogues, price lists or documents relating to the order are approximations in keeping with standard commercial practices.

2. Performance period, impossibility, delay

- 2.1 The delivery dates specified by the Supplier shall be viewed as approximates unless a fixed delivery or performance date has specifically been agreed. A delivery date is considered as met if the goods are handed over to the Customer by the time agreed in Clause 5.2 or upon the Customer receiving notification that the goods are ready to ship.
- 2.2 In the event of subsequent amendments to the contract which could have an effect on the term of the contract, the latter shall be extended accordingly.
- 2.3 If the Supplier is unable to fulfil their obligation to deliver as a result of unforeseen, extraordinary events which, despite taking precautions reasonable for the circumstances in the specific case, are beyond their control - regardless of whether they occur at the Supplier's factory or at the premises of its subcontractors, in particular official interventions, operational disruptions, work disputes, delays to delivery of raw and auxiliary materials or force majeure - the delivery date shall be extended accordingly. If the execution of the contract is unreasonable for any of the parties due to the above-mentioned events, in particular if the execution of the contract is delayed substantially by more than 6 months, that party may request to withdraw from the contract.
- 2.4 If the Supplier does not receive the specific goods for fulfilling an order, or delivery of these is delayed or damaged, he is released from his obligation to supply the sold goods provided that he has taken the necessary steps to ensure timely self-delivery. The Supplier shall be responsible for immediately informing the Buyer in the event of non-availability and proceed with the prompt reimbursement of any services in return already provided.
- 2.5 If the Supplier is at fault for non-compliance with delivery dates or deadlines, the Customer may withdraw from the contract after fruitless expiry of a written, appropriate extension of the deadline. The Buyer may request compensation for damages in accordance with Section 12 of these T&Cs only. The same shall apply for other impossibilities of the Supplier.
- 2.6 In the event of impossibilities of the Supplier, the Buyer shall be obliged to reimburse the Supplier for any services carried out thus far based on the fair market value. The same shall apply if the Supplier is entitled to withdraw from the contract due to contractual or legal guidelines. Additional rights of the Supplier shall remain unaffected.

3. Pricing

- 3.1 Unless otherwise agreed, all prices are understood to be ex-works and exclusive of packaging, shipping, postage and insurance. All prices are quoted exclusive of statutory sales tax.
- 3.2 If prices are not quoted or are to be at "current list prices", the list prices valid at the date of delivery will be charged. If the agreed price is not based on a list price but an agreement between the contractual parties, and the list price, market price or price for a subcontractor service has increased by more than 5% since the point of conclusion of the agreement, the Supplier can request that the agreed price be adjusted accordingly (exemption limit). This shall apply if a delivery term of more than four months is agreed or delivery takes place more than four months after conclusion of the contract for valid reasons outside of the Buyer's control. The preceding provision shall apply for price increases of up to 10%. For greater price adjustments, a new price agreement is required. If the aforementioned comparison price has increased by more than 25% and neither parties agree to a price increase, the Supplier is entitled to withdraw from the contract. The Customer shall have no further rights in this case.

4. Payment terms

- 4.1 Payments are payable upon receipt of invoice and without deduction. Payments made to the Supplier's account within 8 days of receipt of invoice shall receive a 2% discount provided the Buyer is not in default in respect of payment for goods. The Supplier is entitled to send the Customer invoices electronically, i.e. via email.
- 4.2 Should the Supplier become aware after conclusion of the contract of a material adverse change on the part of the Buyer which may endanger his chances of claiming payment, up to the time of his delivery or providing the service agreed he may require the lodgement of a suitable guarantee within a reasonable period or provide his service step-by-step pursuant to Section 232 Para. 1 BGB. The Buyer can assign a qualified guarantor to act as security, to guarantee any claims as a primary liability and who is available for immediate consultation. If the Buyer does not satisfy the Supplier's justifiable demand or does not do so within a reasonable time, the Supplier may terminate the contract. In the event of termination of the contract, the Supplier shall be reimbursed for any preliminary work at the fair market value.
- 4.3 If the Buyer does not make payment in time, despite warning, the Supplier is entitled to discontinue all orders placed by the Buyer in addition to claim to performance and/or other legal or contractual rights.

5. Shipping and transfer of risk

- 5.1 Shipping takes place ex-works. Unless otherwise agreed, the Supplier is not obliged to choose the cheapest shipping option.
- 5.2 Risk shall be transferred to the Customer once the goods have been received by the ordering party. If goods are ready to ship and shipment or space allocation are delayed for reasons outside of the Supplier's control, the risk shall pass to the Buyer upon receipt of notification of readiness for dispatch.

6. Industrial property rights

- 6.1 Any images, drawings and other documents shall remain the property of the Supplier and subject to copyright law; they may not be made available to third parties without the Supplier's consent and must be returned immediately upon request.
- 6.2 If the production of goods based on drawings, samples or other information from Buyer violates the intellectual property rights of third parties, then the Buyer is obligated to release the Supplier from all claims or to compensate him for the damage that he claims to have suffered.

7. Retention of title

- 7.1 The Supplier reserves the title to the delivered goods until all claims have been settled with the Buyer (reserved goods). In the case of payment by means of cheque or bill of exchange, title to the goods is retained until the bill is cleared by the Customer. Cheques will only be accepted on condition of fulfilment and not instead of performance. In the case of current accounts, the retention of title will serve to balance the Supplier's claims. The Buyer is obliged to appropriately insure the reserved goods, at their own expense, against all common risks, particularly fire and theft, and submit proof upon request.
- 7.2 Acquisition of ownership by the Buyer pursuant to Section 950 BGB is not permitted. A potential connection, mixing, filling or manufacturing and processing of the reserved goods with other goods not belonging to the Supplier may take place in the knowledge that the Supplier shall acquire joint property rights of the new item whereby the invoice value of the reserved goods shall correspond to the overall sales value of the new item. The new item shall therefore be considered as reserved goods for the purpose of these conditions and will be stored by the Buyer for the Supplier. Should the Buyer acquire sole ownership of the new item, he shall transfer the co-ownership share to the Supplier in respect of the value of the processed reserved goods.
- 7.3 The Buyer may only sell the reserved goods in the normal course of business and provided he is not in default. The Buyer shall now assign all claims to the Supplier arising as a result of resale to third parties. This assignment occurs only on account of performance. This assignment extends to all future existing claims concerning resale of the reserved goods. If the reserved goods to which we have title are sold by the Buyer together with other goods not delivered or in a processed state by the Supplier, then the receivables ceded to us from the resale will not exceed the invoice value for the reserved goods. In the event of resale of new items of which the Supplier has acquired joint ownership, then the receivables ceded to us shall be the value of the co-ownership share. The assigned claims will serve as security to the Supplier's claims to the same extent as the reserved goods.
- 7.4 The Buyer himself may collect the assigned claims provided he has complied with the payment terms of the business relationship, is not in default and is not subject to insolvency proceedings.

General Terms and Conditions of Business

- 7.5 Should the Buyer not fulfil their contractual obligations, particularly with regard to delayed payment, the Supplier is entitled to demand temporary return of the reserved goods at the Buyer's expense and without exercising the right of withdrawal or setting a grace period.
- 7.6 In cases where third parties access the reserved goods or claims and securities of the Supplier, particularly in the event of pledging or other enforcement measures, the Buyer must indicate the Supplier's ownership and immediately notify the Supplier and provide the documents necessary for an intervention; this shall also apply to impairment of any other kind. The Buyer shall reimburse the Supplier for the costs of resisting such seizures and claims.
- 7.7 The Supplier is obliged to release at his own discretion any securities that he is entitled to in accordance with the above provisions to the extent that the realisable value of such securities exceeds the receivables to be secured by more than 10 percent.
- 8. Moulds and tools**
- 8.1 The costs for moulds or tools to be prepared will be invoiced pro rata and separately from the cost of the goods
- 8.2 Through remuneration of shares of costs for moulds/tools, the Buyer shall not acquire any rights to these; the moulds/tools shall remain the sole property of the Supplier. The Supplier is obliged to store the moulds/tools on the Buyer's behalf for a duration of one year from the final delivery. Should the Buyer provide notification before expiry of this deadline that they intend to place orders within this additional year, the storage period shall be extended further by one year.
- 8.3 Once this period has expired, the Supplier has free access to the moulds/tools. The Buyer may however acquire the moulds/tools by payment of the full costs.
- 9. Warranty**
- 9.1 If the goods delivered are faulty, the Supplier may then choose to either fulfil the order by remedying the defect or supplying a new product. He is obliged to bear the costs for all expenses, particularly transportation, tolls and material costs, required to remedy the defect as far as these costs are not increased by moving the delivery to a place other than the place of performance unless this complies with the use under the provisions of this contract.
- 9.2 If subsequent performance is not effected within a suitable period of time, i.e. a minimum of 2 weeks, or if the second attempt fails as well, the Buyer is entitled to choose between a reduction in the sale price or withdrawal from the contract.
- 9.3 The warranty obligation shall not apply if the Buyer does not use original parts or fixings and replacement parts approved by the Supplier with regards to the use of staplers and pneumatic nailers. The same shall apply to damages arising as a result of chemical influences on fixings used insofar as these are not foreseeable in the contract.
- 9.4 For defects caused by inappropriate or incorrect use, natural wear-and-tear, improper assembly or operation by the recipient or third party, or by incorrect or negligent treatment, warranty shall also not apply nor for the consequences of incorrect changes by the Buyer or third parties or those carried out without the Supplier's authorisation.
- 9.5 See Section 12 for claims for compensation of damages. Clause 12.5 shall apply for the limitation period of warranty claims.
- 10. Examination and notification obligation**
- 10.1 The Buyer is obliged to inspect the goods immediately upon delivery, and no later than immediately after unloading from the means of transport. Any defects, incorrect deliveries or missing items must be reported immediately. This notification must be made in writing. If the goods are being sent on further by the Buyer, inspection must take place at the initial place of delivery regardless. If own know-how is not sufficient, then an expert must be consulted immediately.
- 10.2 The notification period for non-conforming goods shall be two weeks from the date of delivery or release at the agreed location for defects which are detected in the course of proper inspection, and two weeks from the point of detection for defects that were not immediately apparent (hidden defects).
- 10.3 The Buyer must allow the Supplier sufficient opportunity to satisfy itself of the defect and notify them of the place where the goods are located and provide access to the goods. If this obligation is violated or the goods have been further processed, sent on or modified, these goods shall be considered approved. In the event of hidden defects, the Buyer shall bear the burden of proof that the goods were in a defective condition at the time of delivery.
- 10.4 Goods shall be considered approved if violation of obligation occurs pursuant to 11.1 to 11.3, and in the event of incorrect or non-timely notification of such defects that could have been detected upon proper inspection. Section 377 HGB shall apply unless otherwise stipulated in these T&Cs.
- 11. Compensation for breaches of duty**
- 11.1 The Supplier is liable without limitation in accordance with legal guidelines for damages occurring as a result of wilful intent or gross negligence. Excluded hereto is contractual violation due to gross negligence by simple vicarious agents, whereby liability shall be limited to predictable and typically occurring damage.
- 11.2 The Supplier shall be liable for damages from simple negligence if this breaches a material contractual obligation. Material contractual obligations are particularly those which are required in order to achieve the purpose of the contract and on which the customer may rely. In this instance, liability is limited to predictable and typically occurring damage. This liability is limited to a maximum amount of 2500 euros. This maximum liability amount shall also apply once more in the event of multiple breaches of duty (maximum overall amount).
- 11.3 Pursuant to legal guidelines, the Supplier shall be liable without limitation for damages to loss of life, bodily injury or damage to the health of a person. The Supplier's mandatory liability pursuant to product liability law shall also remain unaffected. Limitations of liability pursuant to Clauses 12.1 and 12.2 shall not apply.
- 11.4 Unless otherwise stipulated, compensation claims of the Buyer shall be excluded. The provisions in this clause shall also apply to non-contractual claims for damages as well as in favour of employees and other vicarious agents of the Supplier.
- 11.5 Excluded herewith are cases in which the Supplier is liable without limitation pursuant to the provisions in Section 12, whereby all warranty claims shall become statute-barred within one year as of the start of the statutory limitation period. This shall also apply for subsequent claims for defects. The statute of limitations in the event of a delivery recourse according to §§ 478, 479 BGB remain unaffected. This lasts for 2 years.
- 12. Applicable law, place of delivery, court of jurisdiction**
- 12.1 German law shall apply for all legal obligations and their implementation as well as any claims which may arise under exclusion of the UN Convention on the International Sale of Goods.
- 12.2 The place of fulfilment for all legal obligations is Joh. Friedrich Behrens AG.
- 12.3 The place of jurisdiction for any disputes arising from this contract is Hamburg. The Supplier is entitled to resolve disputes at the court of his registered offices.
- 13. Effectiveness in the event of partial invalidity, offsetting**
- 13.1 Should individual provisions of these contractual conditions be or become invalid, this shall not affect the validity of the other provisions. This ineffective provision shall be replaced by one which most closely resembles the originally intended purpose of the ineffective provision.
- 13.2 With regards to claims by the Supplier, the Buyer is not entitled to make deductions to payment of the purchase price or other claims or connection with the contract or exercise a right of retention unless this claim is known, undisputed or legally recognised. He is only authorised to effect a lien only, as far as his counterclaim is based on the same contractual relationship.
- 14. Special conditions for repairs**
- Repairs which do not come under the warranty in Section 10 are subject to the following conditions in addition to Section I. Insofar as the following provisions deviate from those stipulated in Section I, the following provisions apply.
- 15. Costs for non-executed orders**
- If a repair cannot be performed because the fault cannot be determined under observation of proper engineering standards or the order was withdrawn during implementation, the Buyer shall receive an invoice for any costs incurred.
- 16. Remuneration of a cost estimate**
- If a cost estimate is provided at the Buyer's request, they must remunerate any time-related costs which arise.
- 17. Extended lien on movable items**
- 17.1 The Supplier shall be entitled to a contractual right of lien on the Customer's item in its possession. The right of lien may also be claimed on account of claims arising from earlier work, replacement part deliveries or other services insofar as they relate to the item. For other claims arising from the business relationship, the right of lien is only valid insofar as these are undisputed or legally binding.
- 17.2 If the item is not collected within 4 weeks from the date of the collection request, the Supplier may charge a storage fee upon expiry of this period. If no collection is made after 3 months from the date of the collection request, the Supplier is no longer obliged to store the item and is not liable for minor negligent damage or destruction. The Buyer must be sent a due notice one month prior to expiry of this period. The Supplier is entitled to sell the item at market value upon expiry of this period in order to cover costs. The Buyer shall reimburse any loss in value.
- 18. Retention of title**
- 18.1 Unless spare parts etc. assembled within the scope of repair work become integral parts, the Supplier retains title to any assembled parts until all its claims from the existing contract have been settled.
- 18.2 Should the Buyer be in default, the Supplier may demand that the Buyer return the item to disassemble the built-in parts. The Buyer shall bear the costs of return and disassembly.
- 18.3 Should the Buyer conduct the repair, they must give the Supplier the opportunity to disassemble the item at the Buyer's premises. Labour and toll costs incurred shall be borne by the Buyer.

Ahrensburg, 1 September 2015

BeA Fasteners

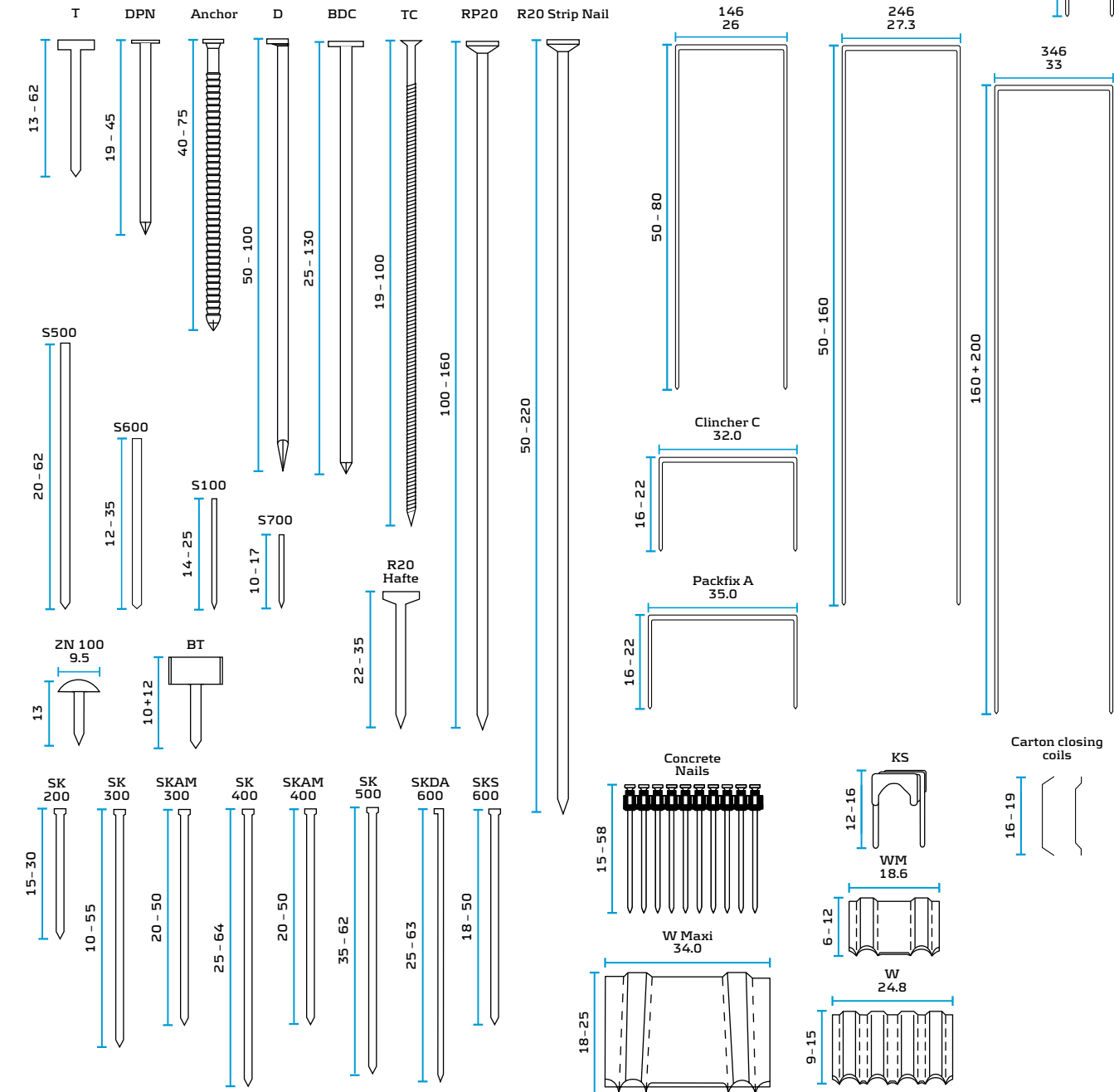
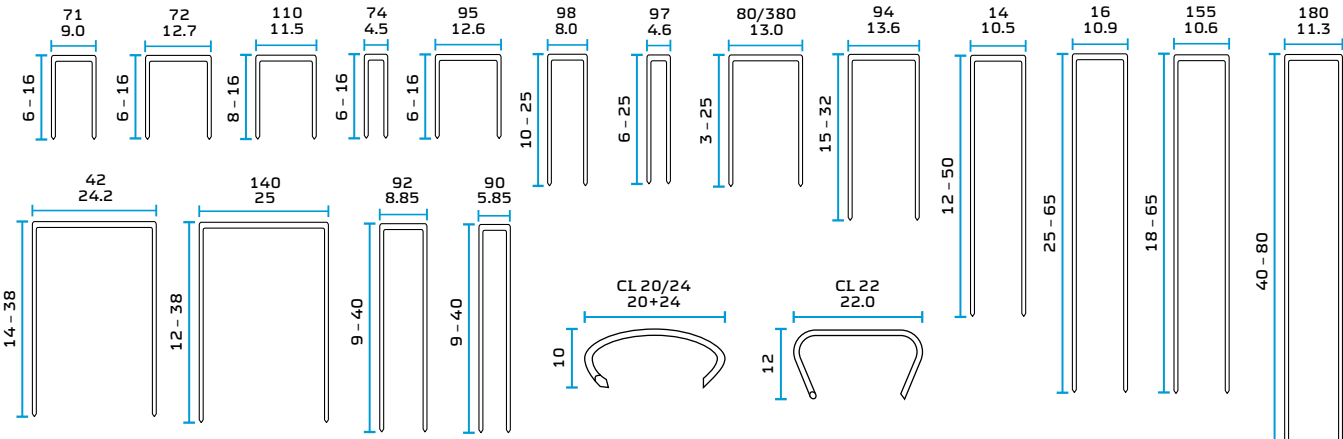



THE POWER OF FASTENING

**Joh. Friedrich Behrens AG
Industrial Fastening Systems**

Bogenstraße 43 - 45, 22926 Ahrensburg, Germany
Tel. +49 (0) 4102 78 - 445
Fax +49 (0) 4102 78 - 270
info@behrens-group.com

www.bea-group.com

