

THE POWER OF FASTENING



BeA Professional Tools and Fastening Systems

# Catalogue

*The complete range for distributors, craftsmen and industry*

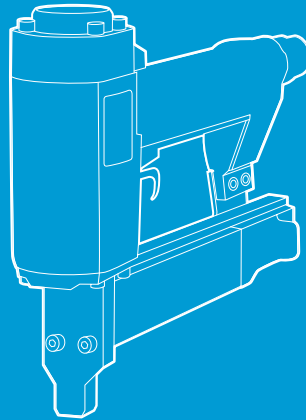
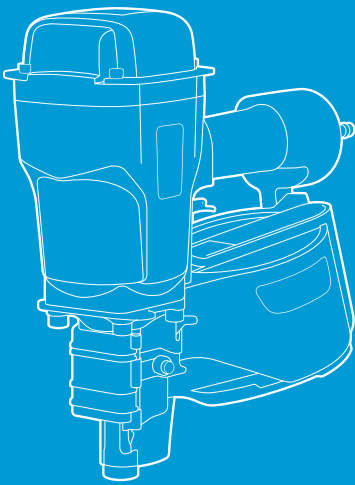

[www.bea-group.com](http://www.bea-group.com)



## BeA Tools and Fasteners – The complete range of fastening solutions for industry

The company BeA was founded in 1910. In more than 100 years of its existence, it has developed into a global group with a total turnover of over 120 million euros, achieving market leadership throughout Europe in the fastening technology field.

The BeA trademark stands for top of the range products in the fastening technology field. BeA pneumatic nailing and stapling tools and fasteners are characterised by top quality and reliability. In order to maintain these high standards in the future, we are constantly optimising and expanding our product range. By using innovative technologies, BeA sets the standards in fastening technology.

BeA tools and fasteners are easy to use and perform with excellent results. They speed up your manufacturing process and are more economical. Our tools are tested in various tough environments and continuously improved.

### BeA GmbH Industrial Fastening Systems

Bogenstraße 43 - 45, 22926 Ahrensburg, Germany  
Tel. +49 (0) 4102 78 - 445  
Fax +49 (0) 4102 78 - 270  
info@bea-group.com

[www.bea-group.com](http://www.bea-group.com)

BeA is a member of  
the following associations:



BeA Headquarters Ahrensburg / Germany







## BeA Nomenclature

### BeA Tool Description

**14/32 - 613**

Staple type  
Max. leg length  
BeA tool type

Shank properties

Smooth Ring Screw

### Material

- BK = Steel, bright
- NK = Steel, electro galvanized
- NK Hard = Steel, galvanized, hard
- NKS = Steel, galvanized, extra hard
- FV = Steel, hot-dipped galvanized
- VZ = Steel, heavy electro-galvanized
- LM = Aluminium
- A2 = Stainless Steel, comparable to material 1.4301
- A4 = Stainless Steel, comparable to material 1.4401
- KU = Copper
- MS = Brass

### Surface properties

- HZ = Steel, resin coated to attain higher withdrawal values
- Ring = Ring shank
- Screw = Screw shank
- NG = Screw nail

*Standard: All BeA Staples, SK Brads and Pins are manufactured with chisel point, except type 346*

*Standard: All BeA BDC and Strip Nails are manufactured with diamond point*

### Staple and nail points

- DP = Divergent point, staple legs divert sideways away from the crown
- IA = Inside chisel point: staple legs turn inwards
- AA = Outside chisel point: staple legs turn outwards
- CD = Rebated edge for gypsum fire board
- SS = Blunt point
- NI = Clinch point

### BeA certificates and classifications



All BeA Pneumatic tools are in compliance with safety regulations as outlined in the EG machinery directive 2006/42/EG and are labelled with the CE mark.



All fasteners available from BeA that are used in building load bearing structures have the characteristics specified in Eurocode 5.



BeA Staples 146, 155, 180, 200 and 246 are now approved with the European Technical Assessment (ETA) for the permanent fixing of wood, wood materials and wood fibre insulation boards, as well as for fixing of soft wood fibre insulation boards with a bulk density starting at 110 kg/m<sup>3</sup>.



EUROPEAN PALLET ASSOCIATION

BeA is a partner of the European Pallet Association and is approved to manufacture EPAL dome head ring nails.

### Service Classes

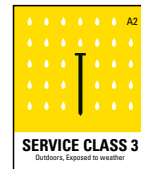

### BeA Staple points

Chisel point    Inside chisel point    Outside chisel point    Divergent point    Groove (flare)



## Contents

	Page
BeA Service	2
BeA International	3
BeA Nomenclature	4
BeA Applications	6-7
BeA Quick Overview	8-9
BeA Reciprocating	10-11
BeA Bedding Applications	12-13
BeA Skater	14-15
BeA Autotec	16-19
BeA Staplers for fine Wire	<i>Staple type 80/380/71/72/95/74/97/98</i>
BeA Staplers for medium Wires	<i>Staple type 90/92/94</i>
BeA Staplers for heavy Wires	<i>Staple type 14/180</i>
BeA Skater for Staples	<i>Staple type 14/180</i>
BeA Staplers for wide crown	<i>Staple type 42/146/145/246/</i>
BeA Staplers for EPAL Staples	<i>Staple type 33</i>
BeA Variant Tools	<i>Staple type 14/16/155/99 T-Nails and SK 300</i>
BeA Staplers for Carton Closing Staples	<i>Carton Closing Staple type Packfix</i>
BeA Stapler for Plastic Staples	<i>Plastic Staple type</i>
Bea Clipping Tools	<i>Staple type 95/195/380</i>
BeA Hog Ring Pliers	<i>Hog Rings</i>
BeA Hand and Hammer Tackers	<i>Staple type A11/R53</i>
BeA Pinners	<i>Pins S 700/ S100</i>
BeA Brad Nailers	<i>Brad type SK 200/300/400/SKAM 300/400</i>
BeA Brad Nailers	<i>Brad Type SKDA 600 / SKS 600</i>
BeA T Nailers	<i>T Nails</i>
BeA Nailers for Corrugated Fasteners	<i>Fastener type WM/W/Maxi W</i>
BeA Coil Nailers	<i>Wire collated BDC Nails</i>
BeA Skater for Coil Nails	<i>Wire collated BDC Nails</i>
BeA Coil Nailers for Nail typer BDC and TC	<i>Coil Nails type BDC and TC</i>
BeA Coil Nailers for EPAL Nails	<i>EPAL Coil Nails</i>
BeA Recipro Saber Saw Blades	<i>Saber Saw Blades</i>
BeA Coil Nailers for Roofing Nails	<i>Roofing Nail type DPN</i>
BeA Anchor Nailer for type TC	<i>Anchor Nail type TC</i>
BeA Anchor Nailer for type R25	<i>Anchor Nail type R25</i>
BeA Anchor Nailer for type R34	<i>Anchor Nail type R34</i>
BeA Strip Nailer for type D34	<i>Fastener type D34</i>
BeA Strip Nailer for type R20	<i>Fastener type R20</i>
BeA Rapid Clip	<i>Staple type 14/16</i>
BeA Bar Code Tools	<i>Staple type 380</i>
BeA Plastic Washer Stapler	<i>Plastic Washers and Staple type G4450</i>
BeA Glazier Tools and Deco Nailers	<i>Brad type SK 300 and Deco nail type ZN</i>
BeA Screwdriver	<i>Collated and Loose Drywall and Timber Screws</i>
BeA BeFIX Screws and BeA XL	72-85
BeA Timber Connectors	86-87
BeA Hotmelt Technology	88-91
BeA Compressors	92-93
BeA Autotec	94-105
BeA VIT-Connectors	106-107
BeA Compressed Air Accessories	108-110
BeA Fasteners	111-113
General Terms and Conditions of Business	114-115

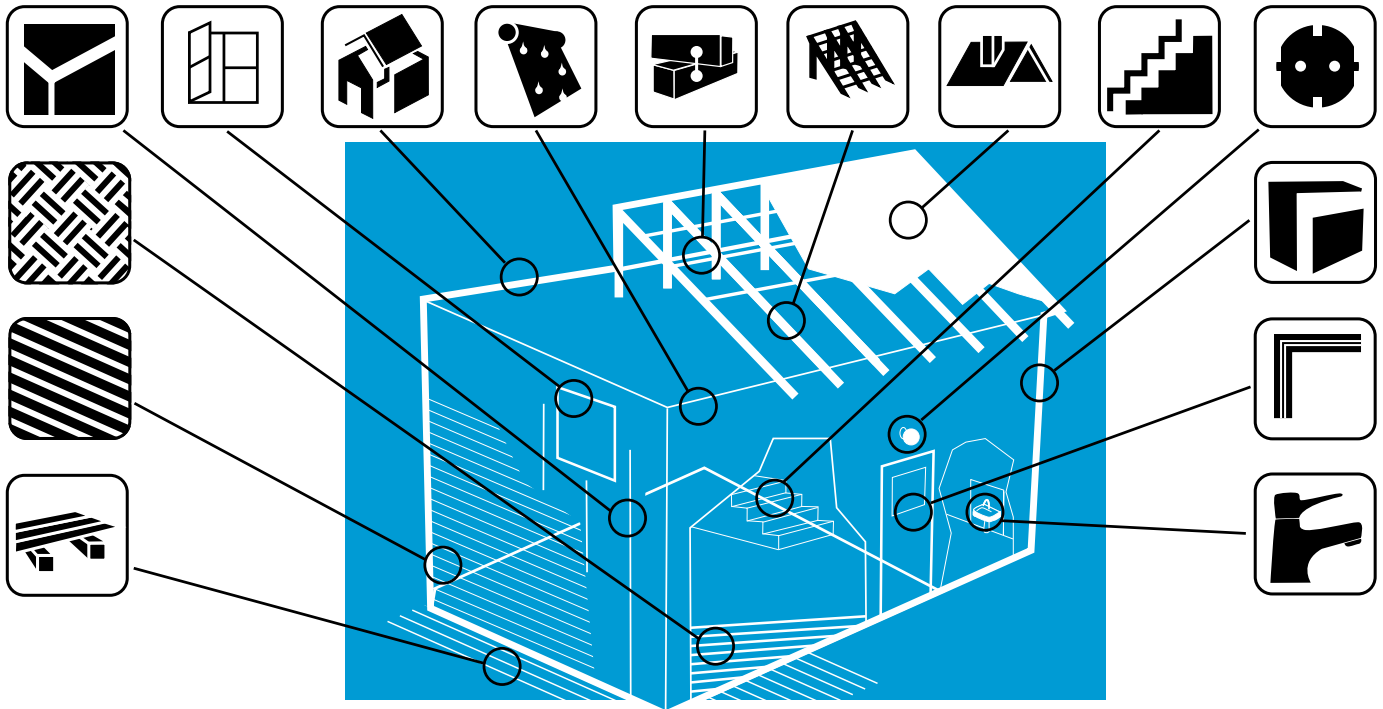

## Construction

Application	Fastener type	Page	Application	Fastener type	Page		
<b>Exterior Cladding</b>	Staple type 14	30, 32, 37	<b>Timber Connectors</b>	Anchor Nails	60-61		
	Staple type 180	31, 33		<b>Roofing</b>	Staple type 155	38	
	Brad type SKDA 600	48	BDC Nails		52-58		
	BDC Nails	52-58	D Head Nails 34°		61-62		
	<b>Inner Construction</b>	TC Nails	57, 59, 61	<b>Roof Truss</b>	R20 Strip Nails	63-65	
<b>Inner Construction</b>		Staple type 97	24		<b>Gypsum Boards</b>	D Head Nails 34°	61-62
		Staple type 90	26			BDC Nails	52-58
		Staple type 92	27			<b>Insulation</b>	Staple type 95
		Staple type 16/155	37-38	Staple type 80/380	21, 41		
		Brad type SK 200	44	Staple type 246	35		
	<b>Door Frames</b>	Brad type SK 300	38, 45	<b>Bathrooms</b>	Roofing Nails	55	
Brad type SKAM 300		46	<b>Windows &amp; Doors</b>		T Nails	38, 45	
<b>Stairs</b>		Brad type SKAM 400		47	<b>Windows &amp; Doors</b>	Brad type SK 300	38, 45
		T Nails	38, 49	Brad type SK 400		46	
	<b>Flooring &amp; Hardwood Floors</b>	Staple type 14	30, 32, 37	Brad type SKAM 300		46	
Staple type 180		31, 33	Brad type SKAM 400	47			
BDC Nails		52-58	Brad type SKDA 600	48			
Brad type SKDA 600		48	Steel Brad type SKS 600	48			
<b>Decks</b>	TC Nails	57, 59, 61					
	Screws	72-75					
	BDC Nails	52-58					
<b>Interior Trim</b>							

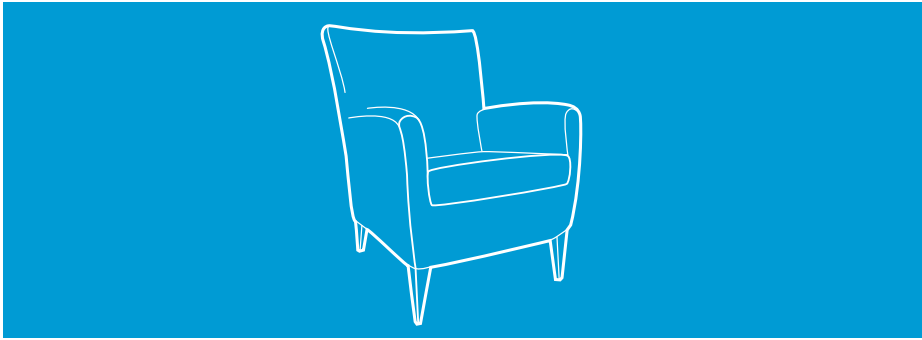

**Furniture**

Application	Fastener type	Page
<b>Chairs and Seats</b>	Staple type 71	22
	Staple type 92	27
	Staple type 80/380	21, 41
	RapidClip	66-67
	Hog Ring	42
	Decorative Nails	68
<b>Cabinets</b>	Pins S 100	44
	Brad type SK 200	44
	Brad type SKAM 300	46
	Collated Screws	72
	Brad type SK 300	38, 45
	Staple type 97	24
	Staple type 92	27

Application	Fastener type	Page
<b>Beds</b>	Staple type 80/380	21, 41
	Staple type 94	28
	Staple type 98	25
	Nail type BDC	52-58

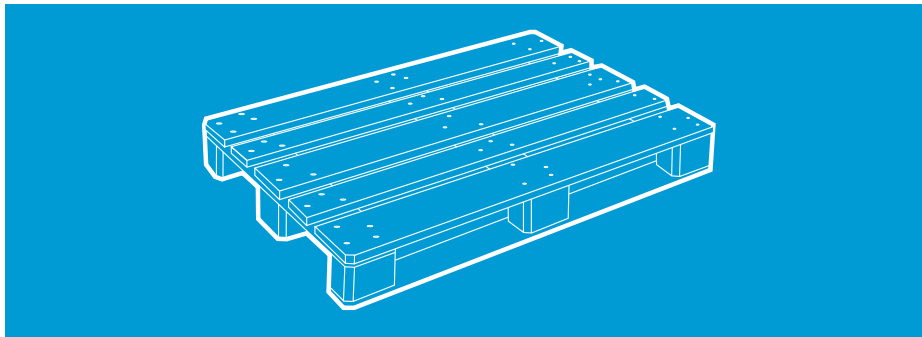

**Packaging**

Application	Fastener type	Page
<b>Packaging</b>	Carton Closing Staples Packfix	39
	Carton Closing Staples Clincher	39
	Staple type 95	23, 40
	Staple type 195	41
	Staple type 42	34
	Hotmelt Sticks	90-99
<b>Crates</b>	Staple type 94	28
	Staple type 14	30, 32, 37
	Staple type 155	38
	Staple type 180	31, 33
	BDC Nails	52-58
	R20 Strip Nails	63-65
	D Head Nails 34°	61-62
XL Packaging Programme	80-87	

Application	Fastener type	Page
<b>Small Crates</b>	Staple type 90	26
	Staple type 92	27
	Staple type 94	28
	Staple type 14	30, 32, 37
	Staple type 16	37-38
	Brad type SK 300	38, 45
<b>Pallets</b>	Brad type SKAM 300	46
	Brad type SK 400	46
	T Nails	38, 45
	Staple type 14	30, 32, 37
	BDC Nails	52-58
	EPAL Dome Head Ring Nails	58
	RECIPRO Saber Saw Blades	58



# BeA – the strong partner in the

## More power and even more products

**BeA Autotec 244**  
with changeover cassette  
for up to 3000 staples  
(21 - 32 mm)



**New**

**BeA Autotec – New Tools**  
(further information on page 16-19 and 94 - 105)

**BeA 346/284 SL**  
for staples 346 (160 - 200 mm)



**BeA 246/284 SL**  
with changeover cassette  
for staples 246  
(100 - 160 mm)



**New**

**BeA Autotec Screwdriver**  
for collated screws 35-80 mm  
in jumbo coils with a capacity  
of 700 screws



**BeA Autotec  
Strip Nailer type 296  
with reloading station  
type 297**  
for strip nails 130-160 mm  
up to Ø 5 mm, magazine capacity  
2 strips (40 nails)



**New**

**BeA Autotec tool 288**  
for jumbo coils up to 2500  
wire collated nails (50 - 80 mm)

**BeA «Pusher»**  
for W12 and K-Coil



## Skater for staples and coil nails

Two handles for operation by 2 people for board widths up to 3 m

- Safety yoke for the operator and the work piece
- Trigger on both handles
- Empty shot control
- Security contact on the circuit board
- Quick-Release
- Rotatable exhaust air cover

Best quality according to Eurocode 5

- Precise adjustment of the penetration depth
- Single actuation available anytime
- Non-marking wheels
- Pull-out handle for comfortable handling

A simple concept for simple maintenance

- The tool can be dismantled from the skater basis within less than 20 sec.

Applications

Timber frame constructions, pre-fabricated housings, packaging industry, all plasterboard, gypsum and wooden boards applications (see page 33 and 50 for more information)



**New**

# and reliable

# fastening industry

Highest quality + ideal solutions



### Pneumatic nailer with two-hand system BeA DC/80-802C Two Hand

BeA has developed a nailer with a two hand system in order to match the new security stipulations. The new double handed actuation system makes sure that the operative permanently has both hands on the tool (see page 50 for more information).

The BeA gas nailer range has been switched to our KMR range, but still offers the same quality, reliability, solidity, as well as all features.

In order to receive our special gas nailer brochure please contact our customer care team at [info@bea-group.com](mailto:info@bea-group.com) or by telephone on +49 (0)4102 78-445.

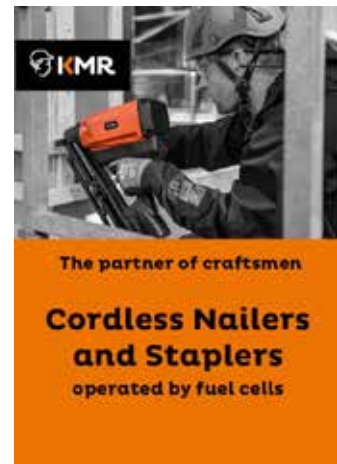

### Saber saw blades

BeA Recipro saber saw blades are specifically used by pallet repair shops and for wooden packages. These long lasting saber blades easily saw through timber and/or steel. BeA saber saw blades fit into all common saws (further information on pages 10-11, 56).



## Many different applications – ideal solutions – one supplier

GET SUPPLIED FROM ONE SOURCE

- High quality standard
- Certified products
- Warehousing and fast delivery times
- Expert consultation on site
- Optimal and custom made solutions
- Stringent quality management
- Less administration





# Reciprocating Saber Saw Blades



**BeA Recipro saber saw blades are specifically used by pallet repair shops and for wooden packages. These long lasting saber blades easily saw through timber and/or steel. BeA Recipro blades fit into all common saws.**

- Extremely durable Bi-Metal welded blades
- Universal feed
- Vario teething especially for nail embedded wood

**Applications**

Pallet repairs, nail embedded wood



**Technical Data**

Item Code	Description	Dimensions	Teething	Tip
11700001	Recipro 200x0.9x19 VTNT	200x0.9x19 mm	Vario Teething (10-14 TPI)	Normal Sharp Tip
11700002	Recipro 230x0.9x19 VTNT	230x0.9x19 mm	Vario Teething (10-14 TPI)	Normal Sharp Tip
11700003	Recipro 200x1.25x19 VTNT	200x1.25x19 mm	Vario Teething (10-14 TPI)	Normal Sharp Tip
11700004	Recipro 230x1.25x19 VTNT	230x1.25x19 mm	Vario Teething (10-14 TPI)	Normal Sharp Tip
11700011	Recipro 230x0.9x19 WTNT	230x0.9x19 mm	Wood Teething (10 TPI)	Normal Sharp Tip
11700018	Recipro 190x1.25x19 VVRT	190x1.25x19 mm	Vario Teething (10-14 TPI)	Reverse Sharp Tip
11700020	Recipro 200x0.9x19 WTNT	200x0.9x19 mm	Wood Teething (10 TPI)	Normal Sharp Tip
11700021	Recipro 200x1.25x19 WTNT	200x1.25x19 mm	Wood Teething (10 TPI)	Normal Sharp Tip
11700023	Recipro 190x0.9x19 VVRT	190x0.9x19 mm	Vario Teething (10-14 TPI)	Reverse Sharp Tip
11700024	Recipro 225x0.9x19 VVRT	225x0.9x19 mm	Vario Teething (10-14 TPI)	Reverse Sharp Tip
11700025	Recipro 225x1.25x19 VVRT	225x1.25x19 mm	Vario Teething (10-14 TPI)	Reverse Sharp Tip
11700026	Recipro 228x1x18.4 VVRT	228x1x18.4 mm	Carbide Teething (8 TPI) <b>NEW</b>	Reverse Sharp Tip

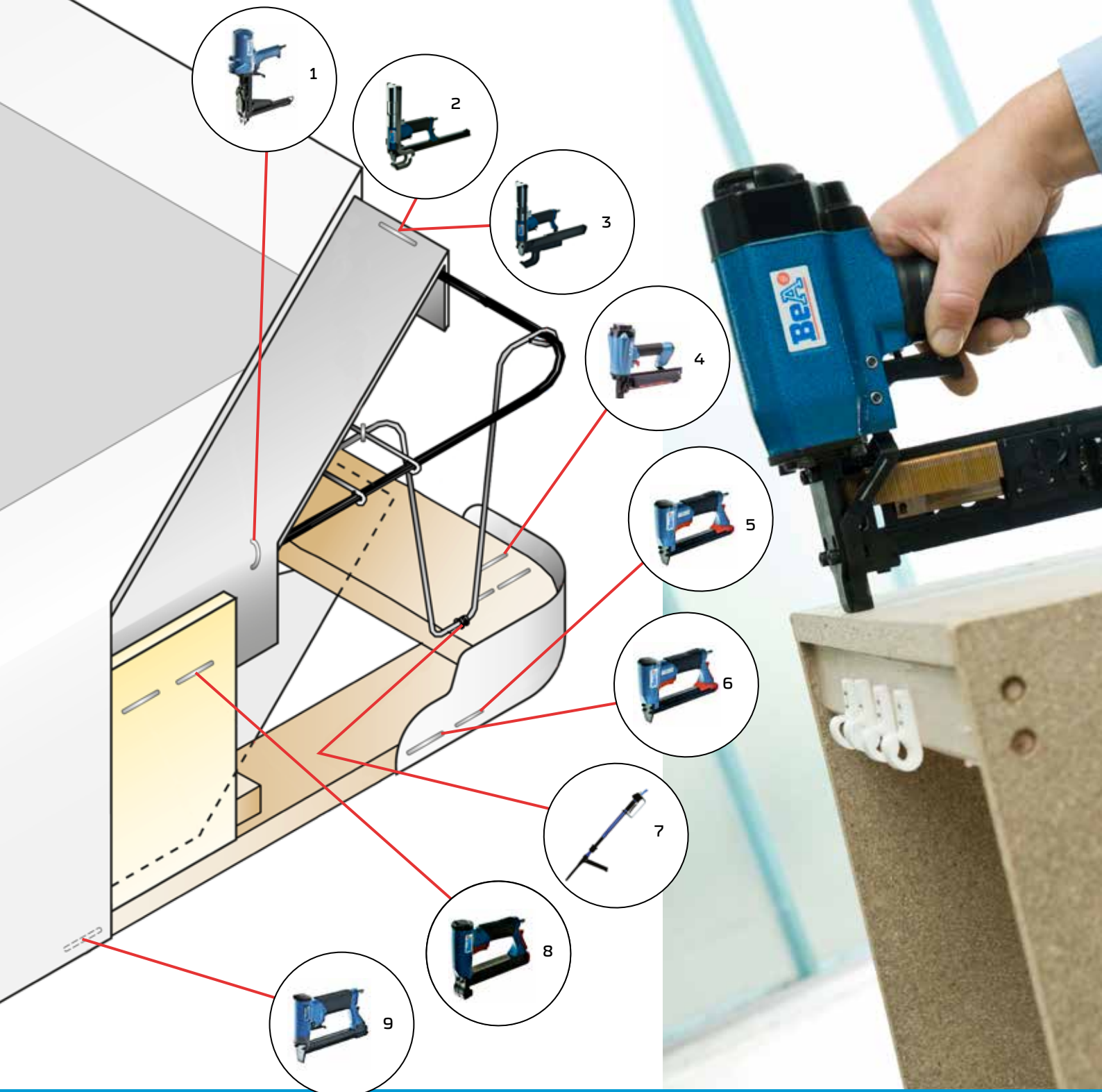











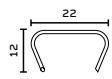

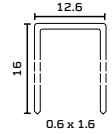

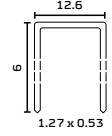

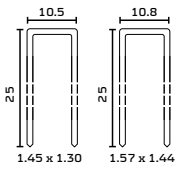
# BeA Bedding Applications

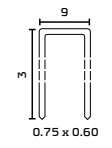
## INDUSTRIAL TOOLS & FASTENERS

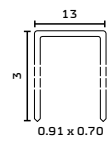
### A complete range of Fastening Solutions for Industry

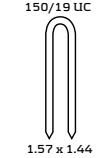
The BeA trademark stands for top of the range products in the fastening technology field. BeA compressed air nail guns and fasteners are characterised by top quality and reliability. In order to maintain these high standards in the future, we are constantly optimising and expanding our product range. By using innovative technologies, BeA sets the standard in fastening technology.

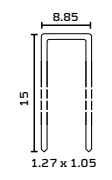
BeA tools and fasteners are easy to use and perform with excellent results. They speed up your manufacturing process and are more economical. Our tools are tested in various tough environments.

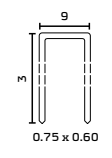
Tool	Technical Data	Application	Fastener
 <p>1</p>	<p><b>HR60-22</b> 12100000</p> <p>Weight: 1.76 kg Magazine: Rear Air consumpt.: .019 cuft/cycle, 5-6 bar Magazine capacity: 50 Fastener: CL22</p>	<p>Mattress spring building up, attaching fabric flanges to inner springs, edge roll to border wire</p>	
 <p>2</p>	<p><b>110/16-414L Plier</b> 12000447</p> <p>Weight: 1.7 kg Magazine: Top Air consumpt.: 0.23 cuft/cycle, 5-6 bar Magazine capacity: 184 Fastener: 110 up to 16 mm</p>	<p>Attaching sisal to border wire</p>	
 <p>3</p>	<p><b>195/25-526</b> 12000150</p> <p>Weight: 2.2 kg Magazine: Top Air consumpt.: 0.29 cuft/cycle, 6-8 bar Magazine capacity: 135 Fastener: 195 up to 25 mm</p>	<p>Attaching sisal to border wire</p>	
 <p>4</p>	<p><b>14/50-780 C</b> 12000522</p> <p>Weight: 2.34 kg Magazine: Top Air consumpt.: .053 cuft/cycle, 6-8 bar Magazine capacity: 50 Fastener: 14 &amp; 16</p>	<p>Foundation frames, heavy build-ups of flat members</p>	
 <p>5</p>	<p><b>71/16-421</b> 12000330</p> <p>Weight: 1.08 kg Magazine: Bottom Air consumpt.: .01 cuft/cycle, 5-6 bar Magazine capacity: 190 Fastener: 71</p>	<p>Stapling corner guards, securing pocketed coils to foundations and attaching ticking to dust covers</p>	
 <p>6</p>	<p><b>380/16-420</b> 12000063</p> <p>Weight: 1.08 kg Magazine: Bottom Air consumpt.: .01 cuft/cycle, 5-6 bar Magazine capacity: 157 Fastener: 80</p>	<p>Stapling metal corner guards, securing pocketed coils to foundations and attaching ticking and dust covers</p>	
 <p>7</p>	<p><b>Rammer</b> single fire/ double fire</p> <p>available on request</p>	<p>Fastening spring wires to foundations</p>	<p>150/19 UC</p> 
 <p>8</p>	<p><b>92/25-553FL</b> 12000450</p> <p>Weight: 1.59 kg Magazine: Bottom Air consumpt.: .01 cuft/cycle, 5-6 bar Magazine capacity: 120 Fastener: 92</p>	<p>Attaching fabric flanges to foam box spring side borders</p>	
 <p>9</p>	<p><b>71/14-451A</b> 12000077</p> <p>Weight: 1.00 kg Magazine: Bottom Air consumpt.: .01 cuft/cycle, 5-6 bar Magazine capacity: 194 Fastener: 71</p>	<p>Attaching ticking and dust covers to foundation bottoms and fastening corner guards</p>	



# BeA Skater - Functions and Features



- Optimal results according to Eurocode 5
- Flexible and adaptable
- Quick, safe and efficient

## Applications

Timber frame constructions, packaging industry, pre-fabricated housing and all other applications where plasterboard, gypsum board and wooden boards (e.g. OSB panels) are to be fitted/attached



# BeA Skater - 2 Skater bases



Item No.	Distance in mm
14412430	Standard: 40; 50; 66,7; 100; 200

available for alternative distances:



Item No.	Distance in mm
14414707	Short: 30/60; 45/90; 90/180



## BeA Skater for Heavy Wire Staples

	Item No.	Description	Fastener type	Length from - to in mm	Capacity/Pieces	Weight incl. base (net)
	12000624*	14/65-830 C Skater	14 16 155	40 - 65	Type 14 168 Staples Type 16 152 Staples Type 155 152 Staples	11.8 kg

## BeA Skater for Heavy Wire Staples

	Item No.	Description	Fastener type	Length from - to in mm	Capacity/Pieces	Weight incl. base (net)
	12000625*	180/65-835 C Skater	180	40 - 65	132	12.2 kg
	12000659*	180/90-839 C Skater	180	50 - 75	132	12.3 kg
	12200112*	K92/12-25 L5P Skater	92	12 - 25	300	13.1 kg

\* Tool without Skater base - fits with Skater base 14412430 (standard distances) and 14414707 (short distances), see page 3

For further information please see pages 32, 33 and 50



*The magazine on the  
BeA Autotec Screwdriver  
has the capacity for  
700 screws.*



**BeA Autotec**

Made in Germany

### For Coil Screws 35 - 80 mm

- Preset penetration depth +/- 2 mm, adjustable in 0.25 mm steps
- Optimal screwing performance
- Noise reduction
- Jumbo coil magazine (700 Screws)
- Optimal screw alignment through screw guide

### Applications









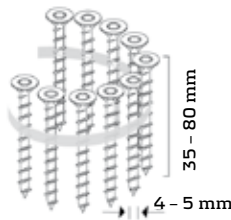

All applications which require flush setting of the screws, e.g. planking of stud frames with Fermacell, chipboards, etc. in the prefabricated house industry

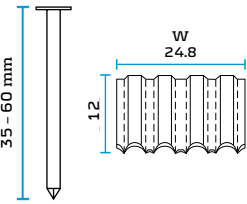

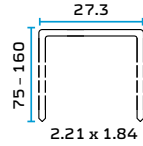
# BeA Autotec Screwdriver

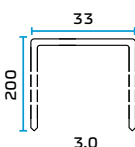
**New**

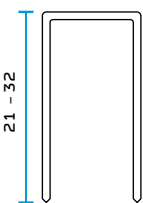

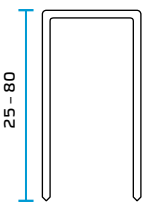



	Description	Capacity	Length from-to	Fastener type
	BeA Autotec Screwdriver	700	35 - 80 mm with conversion kit	
	BeA Autotec Pusher for corrugated nail type W12 and K-Coil	1000	35 - 50 mm	
	246/284 BeA Autotec with change over cassette	550	75 - 160 mm	
	346/284 BeA Autotec	600	200 mm	
	244 BeA Autotec with change over cassette	up to 3000	21 - 32 mm	
	264/284 BeA Autotec with change over cassette	up to 2,300	25 - 80 mm	

further information on page 94-105

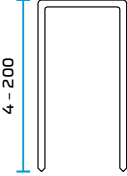
	Description	Capacity	Length from-to	Fastener type
	258/268/288 BeA Autotec for BDC jumbo coils	up to 900	30 - 130 mm	
	288 BeA Autotec for wire collated jumbo coils	up to 2500	50 - 80 mm	
	238/248/268/270 BeA Autotec Strip nailer	up to 400	12 - 120 mm	
	230/240/260 BeA Autotec Top loader	up to 10,000	4 - 65 mm	
	232/242/262/282 BeA Autotec Side loader	up to 2,300	4 - 110 mm	

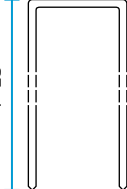
further information on page 94-105

	Description	Capacity	Length from-to	Fastener type
	235/245/265/285 BeA Autotec Long magazine	100-500	4 - 200 mm	
	239 BeA Autotec stationary clinching unit	up to 500	4 - 25 mm	
	236/246/266/296 BeA Autotec Robot Nailer with reloading station 237/247/267/297	up to 30,000	6 - 160 mm	
	BeA Autotec Strip Nailer 296 with reloading station 297	up to 1,800	130 - 160 mm	





further information on page 94-105



# BeA Pneumatic Staplers and Nailers



## BeA Staplers for Fine Wire Staples

Item No.	Description	Fastener type	Length from - to in mm	Capacity/Pieces	Weight (net)
	12000063 380/16-420	80 / 380	6 - 16	157	1.0 kg
	12000075 380/14-450 A Automatic	80 / 380	6 - 14	161	1.2 kg
	12000076 380/14-450 AL Automatic Long magazine	80 / 380	6 - 14	312	1.3 kg
	12000024 380/16-400 Flare	80 / 380	6 - 16	160	1.0 kg
	12000073 380/16-429 LN with 50 mm nose	80 / 380	6 - 16	161	1.4 kg

Item No.	Description	Mille/Box	Mille/Carton	Cartons/Pallet	KG/ Carton
10000731	380/06 NK	24	192.0	48	18.2
10000736	380/08 NK	21	168.0	48	19.0
10000741	380/10 NK	18	144.0	48	18.4
10000750	380/12 NK	15	120.0	48	17.6
10000754	380/14 NK	15	120.0	40	20.0
10000734	380/06 NKS	24	192.0	48	18.2
10000739	380/08 NKS	21	168.0	48	19.0
10000747	380/10 NKS	18	144.0	48	18.4
10000753	380/12 NKS	15	120.0	48	17.6
10000757	380/14 NKS	15	120.0	40	20.0
10000758	380/16 NKS	12	96.0	48	18.1
10003296	80/06 NR A4	25	200.0	40	19.0
10003288	80/08 NR A4	22.5	180.0	40	20.3
10003287	80/10 NR A4	20	160.0	40	20.5
10003297	80/12 NR A4	15	120.0	40	17.6
10003298	80/14 NR A4	15	120.0	40	20.0
10000732	380/06 NK black	24	192.0	48	18.2
10000737	380/08 NK black	21	168.0	48	19.0
10000745	380/10 NK black	18	144.0	48	18.4
10000751	380/12 NK black	15	120.0	48	17.6
10000755	380/14 NK black	15	120.0	40	20.0
10000203	80/06 NK DP	5	200.0	40	19.0
10000216	80/08 NK DP	5	160.0	40	18.9
10003294	80/06 LM	25	200.0	40	7.0
10003286	80/08 LM	22.5	180.0	40	7.4
10003285	80/10 LM	20	160.0	40	7.4
10003284	80/12 LM	15	120.0	40	6.9

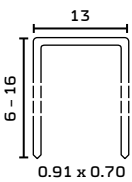



## BeA Staplers for Fine Wire Staples

	Item No.	Description	Fastener type	Length from - to in mm	Capacity/Pieces	Weight (net)
	12000330	71/16-421 with 25 mm nose	71	6 - 16	190	1.0 kg
	12000077	71/14-451 A Automatic Long magazine on request	71	6 - 14	194	1.2 kg
	12000324	71/16-421 Profil	71	6 - 16	190	1.1 kg
	12000074	71/16-436 LN Long nose	71	6 - 16	190	1.0 kg
	12000058	71/16-416 Profil LN Long nose	71	6 - 16	190	1.1 kg

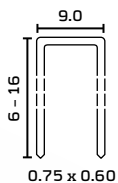
Item No.	Description	Mille/Box	Mille/Carton	Cartons/Pallet	KG/Carton
10000093	71/04 NK	20	480.0	40	21.6
10000095	71/05 NK	20	480.0	40	23.0
10000099	71/06 NK	20	360.0	40	20.9
10004564	71/08 NK	20	240.0	55	15.4
10000112	71/10 NK	20	240.0	50	18.5
10000125	71/12 NK	20	240.0	44	23.0
10001777	71/14 NK	20	160.0	55	16.5
10004239	71/16 NKS	12	168.0	40	20.2



## BeA Staplers for Fine Wire Staples

	Item No.	Description	Fastener type	Length from - to in mm	Capacity/Pieces	Weight (net)
	12000069	72/16-422	72	6 - 16	190	1.0 kg
	12000079	72/14-452 A Automatic	72	6 - 14	194	1.2 kg

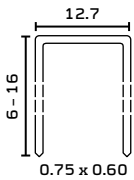

Item No.	Description	Mille/Box	Mille/Carton	Cartons/Pallet	KG/Carton
10000150	72/06 NKS	32.8	262.1	40	18.6
10000154	72/08 NKS	25.5	203.8	40	16.3
10000158	72/10 NKS	21.8	174.7	40	15.2
10000164	72/12 NKS	18.2	145.6	40	15.7
10000166	72/14 NKS	14.6	116.5	40	13.6

	Item No.	Description	Fastener type	Length from - to in mm	Capacity/Pieces	Weight (net)
	12000071	95/16-425	95	6 - 16	114	1.0 kg

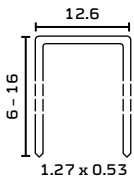



Item No.	Description	Mille/Box	Mille/Carton	Cartons/Pallet	KG/Carton
10001731	95/06 NK	5	140.0	40	15.8
10000433	95/08 NK	5	100.0	40	13.3
10000437	95/10 NK	5	100.0	40	15.3
10000439	95/12 NK	5	80.0	40	13.8
10000441	95/14 NK	5	80.0	40	15.4
10000444	95/16 NK	5	60.0	40	12.8

## BeA Staplers for Fine Wire Staples

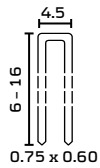
Item No.	Description	Fastener type	Length from - to in mm	Capacity/Pieces	Weight (net)	
	12000042	74/16-404	74	6 - 16	190	1.0 kg



Item No.	Description	Mille/Box	Mille/Carton	Cartons/Pallet	KG/Carton
10000171	74/08 NK	10	300.0	68	16.2
10000174	74/10 NK	10	200.0	68	13.0
10000175	74/12 NK	10	200.0	68	16.6
10000178	74/14 NK	10	200.0	51	18.8
10000182	74/16 NK	10	130.0	68	15.3

Item No.	Description	Fastener type	Length from - to in mm	Capacity/Pieces	Weight (net)	
	12000156	97/25-550	97	10 - 25	156	1.2 kg
	12000048	97/16-407	97	6 - 16	100	1.0 kg

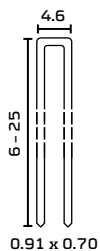

Item No.	Description	Mille/Box	Mille/Carton	Cartons/Pallet	KG/Carton
10000451	97/06 NK HZ	5	275.0	68	15.7
10000457	97/08 NK HZ	15.6	187.2	68	14.6
10001927	97/10 NK HZ	19.5	234.0	52	21.8
10001928	97/12 NK HZ	31.2	187.2	52	21.9
10001929	97/14 NK HZ	27.3	163.8	52	21.1
10001930	97/16 NK HZ	23.4	140.4	52	20.2
10001910	97/19 NK HZ	19.5	117.0	52	19.9
10001931	97/22 NK HZ	15.6	93.6	52	18.4
10001932	97/25 NK HZ	15.6	93.6	52	20.9
10000513	97/22 NR A4	7.8	70.2	65	13.8







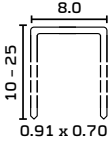

## BeA Staplers for Fine Wire Staples

Item No.	Description	Fastener type	Length from - to in mm	Capacity/Pieces	Weight (net)	
  	12000157	98/25-551	98	10 - 25	168	1.2 kg
	Item No.	Description	Mille/Box	Mille/Carton	Cartons/Pallet	KG/ Carton
	10001936	98/12 NK HZ	19.2	115.2	52	15.0
	10001937	98/14 NK HZ	16.8	100.8	52	14.0
	10001938	98/16 NK HZ	14.4	86.4	52	14.0
	10001939	98/19 NK HZ	12.0	72.0	52	14.0
	10001940	98/22 NK HZ	9.6	57.6	52	13.0
10001941	98/25 NK HZ	9.6	57.6	52	14.0	



## BeA Staplers for Medium Wire Staples

Item No.	Description	Fastener type	Length from - to in mm	Capacity/Pieces	Weight (net)	
      	12000158	90/25-552	90	9 - 25	120	1.2 kg
	12000199	90/32-611 C Contact Actuation Long magazine on request	90	15 - 32	125	1.3 kg
	12000230	90/40-621 C Contact Actuation	90	15 - 40	125	1.4 kg
	12000234	90/40-711 C Contact Actuation	90	15 - 40	125	1.9 kg

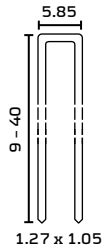
## BeA Staplers for Medium Wire Staples



Item No.	Description	Mille/ Box	Mille/ Carton	Cartons/ Pallet	KG/ Carton
10004105	90/09 NK HZ	9.8	117.6	68	19.5
10002642	90/12 NK HZ	7	70.0	60	15.8
10002643	90/15 NK HZ	6	60.0	60	16.8
10002644	90/18 NK HZ	5	50.0	60	16.7
10002946	90/21 NK HZ	4	40.0	64	15.3
10002646	90/25 NK HZ	3	45.0	48	20.5
10002648	90/30 NK HZ	3	30.0	60	16.4
10002649	90/32 NK HZ	3	30.0	60	17.1
10002650	90/35 NK HZ	2	30.0	48	18.9
10002651	90/38 NK HZ	2	30.0	48	20.8
10002652	90/40 NK HZ	2	20.0	64	14.5
10000309	90/25 NR A4	4.2	37.8	51	17.2
10000330	90/35 NR A4	2.8	33.6	51	21.2

Item No.	Description	Fastener type	Length from - to in mm	Capacity/ Pieces	Weight (net)
 12000159	92/25-553	92	9 - 25	120	1.2 kg
 12000450	92/25-553 Flare	92	9 - 25	120	1.4 kg
 12000437	92/32-632 C Contact Actuation	92	15 - 32	125	1.4 kg
14400902	Adjustable roller guide				

## BeA Staplers for Medium Wire Staples

	Item No.	Description	Fastener type	Length from - to in mm	Capacity/Pieces	Weight (net)
	12000214	92/32-612 AL Automatic Long magazine	92	15 - 32	215	1.9 kg
	12000343	92/40-722 C Contact Actuation	92	15 - 40	211	2.1 kg
	14400891	Height adjustable stop				
	12000630	92/40-772C 	92	25 - 40	210	2.0 kg

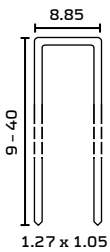



Item No.	Description	Mille/Box	Mille/Carton	Cartons/Pallet	KG/Carton
10000343	92/09 NK HZ	5	50.0	85	9.9
10002653	92/12 NK HZ	8.4	50.4	72	13.0
10002654	92/15 NK HZ	7.2	43.2	72	13.1
10002655	92/18 NK HZ	6	36.0	72	12.8
10002937	92/21 NK HZ	4.8	28.8	80	11.9
10002657	92/25 NK HZ	3.6	21.6	96	10.4
10002943	92/28 NK HZ	3.6	21.6	80	11.7
10002936	92/30 NK HZ*	3.6	21.6	80	12.3
10002660	92/32 NK HZ*	3.6	21.6	72	13.2
10002661	92/35 NK HZ*	2.4	21.6	72	14.2
10002662	92/38 NK HZ*	2.4	14.4	96	10.2
10002663	92/40 NK HZ*	2.4	14.4	80	10.9

\* Conforms to EN14566 and DIN 18182 Part 2



## BeA Staplers for Medium Wire Staples

	Item No.	Description	Fastener type	Length from - to in mm	Capacity/Pieces	Weight (net)
	12000220	94/32-614 C Contact Actuation Automatic on request	94	15 - 32	125	1.6 kg
	12000631	94/40-774C Kontaktauslösung	94	25 - 40	210	2.0 kg

**New**

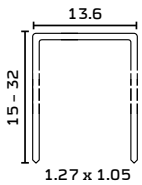

Item No.	Description	Mille/Box	Mille/Carton	Cartons/Pallet	KG/Carton
10000414	94/15 NK HZ	5.0	60.0	40	22.0
10000418	94/18 NK HZ	5.0	50.0	40	21.0
10000420	94/21 NK HZ	5.0	40.0	40	19.0
10000423	94/25 NK HZ	5.0	40.0	40	22.0
10000427	94/32 NK HZ	3.0	24.0	40	16.5
10002947	94/25 NR A4	5.0	40.0	40	22.0

## BeA Staplers for Heavy Wire Staples

Item No.	Description	Fastener type	Length from - to in mm	Capacity/Pieces	Weight (net)
 12000215	14/32-613 C Contact Actuation Long magazine on request	14 16 155	15 - 32	Type 14 168 Staples Type 16 102 Staples Type 155 102 Staples	1.4 kg
	14400847	Roller edge guide			
 12000533	14/40-770 C Contact Actuation	14 16 155	18 - 40	Type 14 168 Staples Type 16 152 Staples Type 155 152 Staples	1.9 kg
	 12000522	14/50-780 C Contact Actuation	14 16 155	32 - 50	Type 14 168 Staples Type 16 152 Staples Type 155 152 Staples
 12000649		14/50-785 A Automatic	14 16 155	32 - 50	Type 14 168 Staples Type 16 152 Staples Type 155 152 Staples
	 12000506	14/65-830 C Contact Actuation	14 16 155	40 - 65	Type 14 168 Staples Type 16 152 Staples Type 155 152 Staples
 12000651		14/65-830 A Automatic	14 16 155	40 - 65	Type 14 168 Staples Type 16 152 Staples Type 155 152 Staples



## BeA Staplers for Heavy Wire Staples

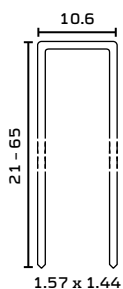
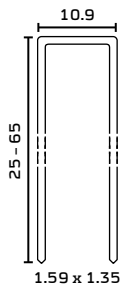
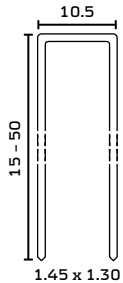

Item No.	Description	Mille/ Carton	Cartons/ Pallet	KG/ Carton
10000005	14/15 NK HZ	39.0	54	16.2
10000013	14/18 NK HZ	31.2	54	15.9
10000019	14/21 NK HZ	27.3	54	15.7
10000024	14/25 NK HZ	23.4	54	15.3
10000031	14/28 NK HZ	23.4	54	17.4
10000033	14/30 NK HZ	23.4	54	18.5
10003384	14/32 NK HZ	10.0	116	8.5
10004811	14/35 NK HZ*	10.0	96	9.2
10003385	14/38 NK HZ*	10.0	96	10.0
10004787	14/40 NK HZ*	10.0	84	10.3
10003386	14/45 NK HZ	10.0	75	11.5
10003387	14/50 NK HZ	10.0	75	12.9
10000029	14/25 NR HZ A4 DP	12.0	119	7.9
10003748	16/25 NK HZ	20.2	54	15.8
10003690	16/30 NK HZ	20.2	54	19.7
10004789	16/32 NK HZ	10.0	88	10.4
10004804	16/35 NK HZ	10.0	88	10.9
10002618	16/38 NK HZ*	10.0	88	11.8
10003352	16/40 NK HZ*	10.0	88	12.4
10002619	16/45 NK HZ*	10.0	80	13.6
10002620	16/50 NK HZ*	10.0	60	15.1
10003751	16/60 NK HZ*	10.0	54	18.7
10003693	16/65 NK HZ*	10.0	45	20.2
10003268	16/32 NK HZ	16.8	54	17.4
10003270	16/38 NK HZ	10.0	88	11.8
10003272	16/45 NK HZ	10.0	80	13.6
10003274	16/50 NK HZ	10.0	60	15.1
10000604	155/21 NK HZ CD	13.0	68	9.2
10000629	155/45 NR HZ A4	9.0	85	12.2
10002051	155/50 NR HZ A4	7.0	85	11.0
10004890	155/45 VZ HZ	10.0	80	13.6
10004838	155/50 VZ HZ	10.0	60	15.1
10002719	155/56 VZ HZ	10.9	54	20.2
10002177	155/65 VZ HZ	10.9	45	22.5

\* Conforms to EN14566 and DIN 18182 Part 2



Staple type 155 in heavy galvanized and stainless steel (A4) are certified to DIN 1052 and have the required characteristics specified in Eurocode 5. Further information on page 4



For information  
[www.bea-group.com](http://www.bea-group.com)  
 or call +49 (0)4102 78-445



## BeA Staplers for Heavy Wire Staples

Item No.	Description	Fastener type	Length from - to in mm	Capacity/Pieces	Weight (net)
	12000500 180/65-835 C Contact Actuation	180	40 - 65	132	2.7 kg
	12000650 180/65-835 A Automatic	180	40 - 65	132	2.7 kg
	12000541 180/90-839 C Contact Actuation	180	40 - 90	132	3.1 kg

Item No.	Description	Mille/ Carton	Cartons/ Pallet	KG/ Carton
10004812	180/40 NK HZ	10,0	65	16,6
10004800	180/45 NK HZ	10,0	63	18,3
10004836	180/50 NK HZ	5,0	84	10,6
10004864	180/55 NK HZ	5,0	78	11,2
10004865	180/60 NK HZ	5,0	78	12,1
10004801	180/63 NK HZ	5,0	78	12,7
10004813	180/65 NK HZ	5,0	78	13,1
10002076	180/70 NK HZ	3,8	102	11,6
10002077	180/75 NK HZ	3,2	102	9,8
10001810	180/80 NK HZ	3,2	102	10,5
10003482	180/90 NK HZ	3,8	68	13,2
10004835	180/45 VZ HZ	10,0	63	18,3
10004837	180/50 VZ HZ	5,0	84	10,6
10005445	180/56 VZ HZ	8,6	54	20,7
10005360	180/63 VZ HZ	5,0	78	12,7
10000697	180/65 VZ HZ	4,0	102	10,5
10000676	180/50 NR HZ A4	5,0	102	10,6
10000692	180/63 NR HZ A4	4,0	102	10,2

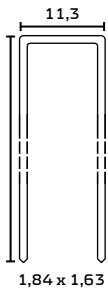

Staple type 180 in heavy galvanized and stainless steel (A4) are certified to DIN 1052 and have the required characteristics specified in Eurocode 5. Further information on page 4



## BeA Skater for Heavy Wire Staples

Item No.	Description	Fastener type	Length from - to in mm	Capacity/Pieces	Weight incl. base
 12000624*	Skater 14/65-830 C	14	40 - 65	Type 14	11.8 kg
		16		Type 16	
155	Type 155				

\* Tool without Skater base - fits with Skater base 14412430 (standard distances) and 14414707 (short distances)

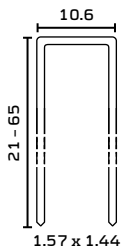
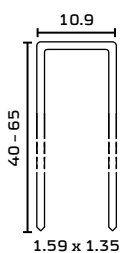
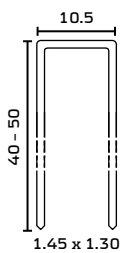

Item No.	Description	Mille/ Carton	Cartons/ Pallet	KG/ Carton
10004787	14/40 NK HZ*	10.0	84	10.3
10003386	14/45 NK HZ	10.0	75	11.5
10003387	14/50 NK HZ	10.0	75	12.9
10003352	16/40 NK HZ*	10.0	88	12.4
10002619	16/45 NK HZ*	10.0	80	13.6
10002620	16/50 NK HZ*	10.0	60	15.1
10003751	16/60 NK HZ*	10.0	54	18.7
10003693	16/65 NK HZ*	10.0	45	20.2
10003272	16/45 NK HZ	10.0	80	13.6
10003274	16/50 NK HZ	10.0	60	15.1
10000604	155/21 NK HZ CD	13.0	68	9.2
10004890	155/45 VZ HZ	10.0	80	13.6
10004838	155/50 VZ HZ	10.0	60	15.1
10002719	155/56 VZ HZ	10.9	54	20.2
10002177	155/65 VZ HZ	10.9	45	22.5
10000629	155/45 NR HZ A4	9.0	85	12.2
10002051	155/50 NR HZ A4	7.0	85	11.0

\* Conforms to EN14566 and DIN 18182 Part 2





Item No.	Description	Fastener type	Length from - to in mm	Capacity/Pieces	Weight incl. base
 12200112*	K92/12-25 L5P Skater	92	12 - 25	300	4.1 kg

\* Tool without Skater base - fits with Skater base 14412430 (standard distances) and 14414707 (short distances)



Item No.	Description	Mille/ Box	Mille/ Carton	Cartons/ Pallet	KG/ Carton
10002653	92/12 NK HZ	8,4	50,4	72	13,0
10002654	92/15 NK HZ	7,2	43,2	72	13,1
10002655	92/18 NK HZ	6	36,0	72	12,8
10002937	92/21 NK HZ	4,8	28,8	80	11,9
10002657	92/25 NK HZ	3,6	21,6	96	10,4

## BeA Skater for Heavy Wire Staples



Item No.	Description	Fastener type	Length from - to in mm	Capacity/Pieces	Weight (incl. base)
 12000625*	Skater 180/65-835 C	180	40 - 65	132	3.2kg
 12000659*	180/90-839 Skater 	180	50 - 75	132	3.2kg

\* Tool without Skater base - fits with Skater base 14412430 (standard distances and 14414707 (short distances)



Item No.	Description	Mille/ Carton	Cartons/ Pallet	KG/ Carton
10004812	180/40 NK HZ	10,0	65	16,6
10004800	180/45 NK HZ	10,0	63	18,3
10004836	180/50 NK HZ	5,0	84	10,6
10004864	180/55 NK HZ	5,0	78	11,2
10004865	180/60 NK HZ	5,0	78	12,1
10004801	180/63 NK HZ	5,0	78	12,7
10002076	180/70 NK HZ	3,8	102	11,6
10002077	180/75 NK HZ	3,2	102	9,8
10004813	180/65 NK HZ	5,0	78	13,1
10004835	180/45 VZ HZ	10,0	63	18,3
10004837	180/50 VZ HZ	5,0	84	10,6
10005445	180/56 VZ HZ	8,6	54	20,7
10005360	180/63 VZ HZ	5,0	78	12,7
10000676	180/50 NR HZ A4	5,0	102	10,6
10000692	180/63 NR HZ A4	4,0	102	10,2

Staple type 180 in heavy galvanized and stainless steel (A4) are certified to DIN 1052 and have the required characteristics specified in Eurocode 5. Further information on page 4

Item No.	Accessories for Skater
14414707	Skater (short distances 30/60mm; 45/90mm; 90/180mm) basis without tool
14412430	Skater (standard distances) basis without tool
 14412428	Edge guide
 14412429	Extension handle
14406482	Rail 3.0 m (in connection with edge guide)
14409063	Rail 3.5 m (in connection with edge guide)
14412767	Rail guide set for Festool rail



## BeA Staplers for Wide Crown Staples

Item No.	Description	Fastener type	Length from - to in mm	Capacity/Pieces	Weight (net)
 12000663	42/40-776 C Contact Actuation	42	18 - 40	148	2.2 kg

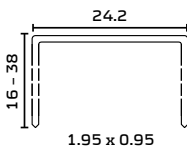



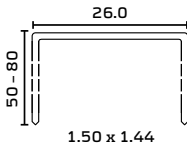

Item No.	Description	Mille/ Carton	Cartons/ Pallet	KG/ Carton
10002724	42/16 NK	16.4	68	12.6
10002725	42/19 NK	13.3	68	11.4
10002726	42/22 NK	11.5	68	10.9
10002727	42/25 NK	10.7	68	11.0
10002729	42/30 NK	8.9	68	10.4
10002730	42/35 NK	7.1	68	9.4
10002632	42/38 NK	7.1	68	9.9

Item No.	Description	Fastener type	Length from - to in mm	Capacity/Pieces	Weight (net)
 12200061	146/80-159 C Contact Actuation	146	50 - 80	150	3.0 kg



Item No.	Description	Mille/ Carton	Cartons/ Pallet	KG/ Carton
10003383	146/50 NK HZ	3.0	102	7.5
10002349	146/75 VZ HZ	2.0	102	6.0
10003809	146/75 NR HZ	2.0	102	6.0

Item No.	Description	Fastener type	Length from - to in mm	Capacity/Pieces	Weight (net)
 12000639	145/40-779C 	140/145	18 - 40	150	2.2 kg
 12000648	145/20-778C 	140/145	12 - 20	150	2.2 kg
 12000194	145/32-178 Contact Actuation	140	12-32	165	2.3 kg



## BeA Staplers for Wide Crown Staples

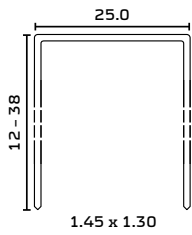

Item No.	Description	Mille/ Carton	Cartons/ Pallet	KG/ Carton
10001796	140/14 NK HZ	20.0	68	11.7
10001797	140/16 NK HZ	18.0	68	11.5
10001798	140/19 NK HZ	14.0	68	9.9
10001799	140/22 NK HZ	12.0	68	9.4
10001800	140/25 NK HZ	12.0	68	10.3
10001801	140/30 NK HZ	10.0	68	9.8
10001802	140/35 NK HZ	8.0	68	8.8
10001803	140/38 NK HZ	8.0	68	9.3



Item No.	Description	Fastener type	Length from - to in mm	Capacity/ Pieces	Weight [net]
12100471	246/130-944 E Single Actuation	246	65 - 130	120	5.4 kg
12100476	246/160-964 E Single Actuation	246	65 - 160	125	6.3 kg
14001504	Pressure reduction valve 6 bar R 1/4				

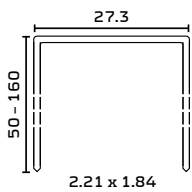

Item No.	Description	Mille/ Carton	Cartons/ Pallet	KG/ Carton
10004384	246/75 RF HZ A2	2.9	63	13.7
10003885	246/90 RF HZ A2	2.9	54	14.9
10003890	246/100 RF HZ A2	2.9	60	16.9
10004523	246/105 RF HZ A2	2.9	45	19.8
10003891	246/110 RF HZ A2	2.9	45	19.2
10003892	246/120 RF HZ A2	1.4	90	10.3
10003893	246/130 RF HZ A2	1.4	96	11.0
10001917	246/150 RF HZ A2	1.4	63	12.4

\* Staple type 180 246 in stainless steel have the required characteristics specified in Eurocode 5.  
Further information on page 4

## BeA Staplers for EPAL Staples



Item No.	Description	Fastener type	Length from - to in mm	Capacity/ Pieces	Weight [net]
12000662	Stapler 33/13-777 for EPAL Staples Contact Actuation	33	13 mm	80	2.2 kg
12300970	BeA Autotec 33/13 L5E for EPAL Staples	33	13 mm	280	4.0 kg



BeA is a partner of the European Pallet Association (EPAL). BeA produces all embossed staples for the EPAL Association. These staples are only available directly from the EPAL Association.

## BeA Variant Tools





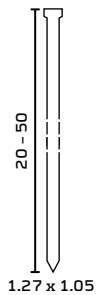
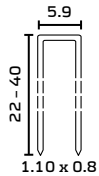

Item No.	Description	Fastener type	Length from - to in mm	Capacity/Pieces	Weight (net)
12100347	Variant Tool 229 C Contact Actuation	99 SK 300	Staples 22 - 40 SK Nails 20 - 50	Staples 100 SK Nails 80	1.4 kg





Item No.	Description	Mille/Box	Mille/Carton	Cartons/Pallet	KG/Carton
10000568	99/25 NK HZ	4	40.0	68	14.9
10000569	99/30 NK HZ	4	40.0	68	17.4
10000571	99/40 NKS HZ	3.2	25.6	68	14.3
10300644	SK 320 NK	5	60.0	60	10.9
10300645	SK 325 NK	5	60.0	60	13.7
10300646	SK 330 NK	5	60.0	60	16.1
10300717	SK 332 NK	5	60.0	48	17.9
10300648	SK 335 NK	5	50.0	51	16.0
10300649	SK 338 NK	5	50.0	51	16.7
10300650	SK 340 NK	5	50.0	51	17.8
10300651	SK 345 NK	5	40.0	40	16.1
10300652	SK 350 NK	5	40.0	40	17.8

For information  
[www.bea-group.com](http://www.bea-group.com)  
 or call +49 (0)4102 78-445

## BeA Staplers for Carton Closing Staples

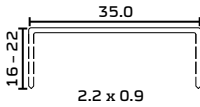
	Item No.	Description	Fastener type	Length from - to in mm	Capacity/Pieces	Weight (net)
	12100278	MT A18 Manual	Packfix	16 - 19	100	2.1 kg
	12100281	MT A22 Manual	Packfix	19 - 22	100	2.1 kg
	12100282	AT A18 Pneumatic	Packfix	16 - 19	100	2.5 kg
	12100283	AT A22 Pneumatic	Packfix	19 - 22	100	2.5 kg

	Item No.	Description	Mille/Box	Mille/Carton	Cartons/Pallet	KG/Carton
	10002763	Packfix 5/8 VK (35/15)	2	20.0	36	18.7
	10002764	Packfix 3/4 VK (35/18)	2	20.0	36	19.5
	10002765	Packfix 7/8 VK (35/22)	2	16.0	32	21.0

	Item No.	Description	Fastener type	Length from - to in mm	Capacity/Pieces	Weight (net)
	12100287	CT IC 1823 Coil Pneumatic	Packfix coil GR I	16 - 19	1 Coil	2.5 kg

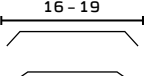
	Item No.	Description	Mille/Carton	Cartons/Pallet	KG/Carton
	10002775	Packfix coil GR I, 5/8 VK	24.0	48	20.3
	10002776	Packfix coil GR I, 3/4 VK	24.0	48	22.8



## BeA Stapler for Plastic Staples

Item No.	Description	Fastener type	Length from - to in mm	Capacity/Pieces	Weight (net)
12000358	P8/16-428 for Plastic Staples Also available with safety yoke	P8	10 - 15	76	1.0 kg

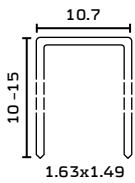

Item No.	Description	Mille/Box	Mille/ Carton	Cartons/ Pallet	KG/ Carton
10002611	Plastic Staple P8/10	10.1	201.6	9	16.6
10004563	Plastic Staple P8/15	8.0	159.6	24	18.0

## BeA Pneumatic Clipping Tool

Item No.	Description	Fastener type	Length from - to in mm	Capacity/Pieces	Weight (net)
12000060	95/16-418 Long magazine on request	95	6 - 16	114	1.4 kg

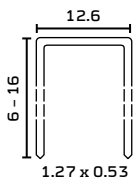

Item No.	Description	Mille/Box	Mille/ Carton	Cartons/ Pallet	KG/ Carton
10001731	95/06 NK	5	140.0	40	15.8
10000433	95/08 NK	5	100.0	40	13.3
10000437	95/10 NK	5	100.0	40	15.3
10000439	95/12 NK	5	80.0	40	13.8
10000441	95/14 NK	5	80.0	40	15.4
10000444	95/16 NK	5	60.0	40	12.8





## BeA Pneumatic Clipping Tool



Item No.	Description	Fastener type	Length from - to in mm	Capacity/Pieces	Weight [net]
12000062	380/16-419	80/380	6 - 16	160	1.4 kg

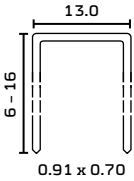

Item No.	Description	Mille/Box	Mille/Carton	Cartons/Pallet	KG/ Carton
10000731	380/06 NK	24	192.0	48	18.2
10000736	380/08 NK	21	168.0	48	19.0
10000741	380/10 NK	18	144.0	48	18.4
10000750	380/12 NK	15	120.0	48	17.6
10000754	380/14 NK	15	120.0	40	20.0
10000758	380/16 NKS	12	96.0	48	18.1



Item No.	Description	Fastener type	Length from - to in mm	Capacity/Pieces	Weight [net]
12000150	195/25-526	195	15 - 25	135	1.8 kg



12200081	195/25-526 with 130 mm throat	195	15 - 25	135	2.2 kg
----------	-------------------------------	-----	---------	-----	--------



Item No.	Description	Mille/Box	Mille/Carton	Cartons/Pallet	KG/ Carton
10000706	195/15 NK	5	50.0	40	18.0
10000707	195/18 NK	5	40.0	40	16.5
10000708	195/21 NK	5	30.0	40	14.0
10000709	195/25 NK	5	30.0	40	15.0

## BeA Hog Ring Pliers

	Item No.	Description	Fastener type	Length from - to in mm	Capacity/Pieces	Weight (net)
	12100604	Hog Ring Plier CL 20 Flex-HR 65 LN	Hog Ring CL 20	-	140	1.6 kg

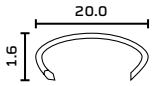

Item No.	Description	Mille/Box	Mille/Carton	Cartons/Pallet	KG/ Carton
10001916	Hog Ring CL 20x1.6 NK Flexible	4.2	33.6	40	15.5

	Item No.	Description	Fastener type	Length from - to in mm	Capacity/Pieces	Weight (net)
	12100447	Hog Ring Plier CL 24-HR 68	Hog Ring CL 24	-	140	1.6 kg

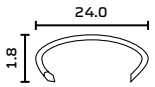

Item No.	Description	Mille/Box	Mille/Carton	Cartons/Pallet	KG/ Carton
10001744	Hog Ring CL 24 NK Flexible	5.0	25.0	34	21.1



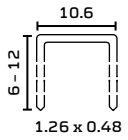

## BeA Manual Hand and Hammer Tacker

Item No.	Description	Fastener type	Length from - to in mm	Capacity/Pieces	Weight (net)
 12100028	Hammer Tacker HT11	A 11	6 - 10	168	1.0 kg



Item No.	Description	Mille/Box	Mille/Carton	Cartons/Pallet	KG/ Carton
10004652	A 11/06 NK	5	100.0	60	11.5
10000711	A 11/08 NK	5	100.0	40	12.6
10000712	A 11/10 NK	5	100.0	40	14.8
10002246	A 11/12 NK	5	80.0	40	13.9

Item No.	Description	Fastener type	Length from - to in mm	Capacity/Pieces	Weight (net)
 12100031	Rapid 153	53	6 - 8	156	0.5 kg
 12100032	Rapid 353	53	6 - 14	156	0.8 kg

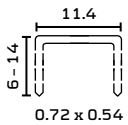

Item No.	Description	Mille/Box	Mille/Carton	Cartons/Pallet	KG/ Carton
10003129	R 53/06 NK	2.5	135.0	51	9.3
10003130	R 53/08 NK	2.5	105.0	51	9.4



## BeA Pinner

Item No.	Description	Fastener type	Length from - to in mm	Capacity/Pieces	Weight (net)
12000052	S 717-410	S 700	10 - 17	130	1.0 kg



Item No.	Description	Mille/Box	Mille/ Carton	Cartons/ Pallet	KG/ Carton
10100037	S 710 NK	12	288.0	84	8.6
10100038	S 712 NK	12	240.0	84	8.6
10100039	S 714 NK	12	216.0	84	9.3
10100040	S 717 NK	12	168.0	84	8.6

Item No.	Description	Fastener type	Length from - to in mm	Capacity/Pieces	Weight (net)
12000439	S 125-569	S 100	14 - 25	126	1.1 kg

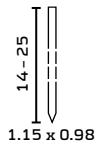

Item No.	Description	Mille/Box	Mille/ Carton	Cartons/ Pallet	KG/ Carton
10100001	S 114 NK	5	90.0	84	9.3
10100003	S 116 NK	5	80.0	84	9.0
10100005	S 119 NK	5	70.0	84	9.7
10100008	S 122 NK	5	60.0	84	9.5
10100010	S 125 NK	5	50.0	84	9.2

## BeA Brad Nailers

Item No.	Description	Fastener type	Length from - to in mm	Capacity/Pieces	Weight (net)
12000476	SK 240-225C Contact Actuation with case	SK 200	12 - 40	180	1.3 kg







Item No.	Description	Mille/Box	Mille/ Carton	Cartons/ Pallet	KG/ Carton
10300669	SK 215 NK	16.0	160.0	56	12.0
10300666	SK 218 NK	16.0	160.0	56	12.0





## BeA Brad Nailers

Item No.	Description	Fastener type	Length from - to in mm	Capacity/Pieces	Weight (net)
	12100004 SK 335-201 with case	SK 300	10 - 35	100	0.8 kg
	12000225 SK 338-616 C Contact Actuation	SK 300	22 - 38	125	1.6 kg
	12000467 SK 350-224 C Contact Actuation with case	SK 300	18 - 50	104	1.2 kg
	12100666 SK 355-214 E Single Actuation with case	SK 300	15 - 55	100	1.3 kg



Item No.	Description	Mille/Box	Mille/Carton	Cartons/Pallet	KG/Carton
10300449	SK 310 NK	5	100.0	72	8.5
10300261	SK 314 NK	5	100.0	72	13.4
10300643	SK 315 NK	5	100.0	60	13.8
10300670	SK 316 NK	5	100.0	72	15.0
10300268	SK 319 NK	5	100.0	72	17.5
10300644	SK 320 NK	5	60.0	60	10.9
10300645	SK 325 NK	5	60.0	60	13.7
10300646	SK 330 NK	5	60.0	60	16.1
10300717	SK 332 NK	5	60.0	48	17.9
10300648	SK 335 NK	5	50.0	51	16.0
10300649	SK 338 NK	5	50.0	51	16.7
10300650	SK 340 NK	5	50.0	51	17.8
10300651	SK 345 NK	5	40.0	40	16.1
10300652	SK 350 NK	5	40.0	40	17.8
10300337	SK 330 NR A4	5	60.0	60	17.6
10300338	SK 335 NR A4	5	50.0	51	16.5



## BeA Brad Nailers



Item No.	Description	Fastener type	Length from - to in mm	Capacity/Pieces	Weight (net)
12100233	SKAM 350-226 C Contact Actuation with case	SKAM 300	20 - 50	128	1.4 kg

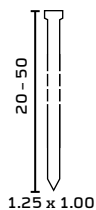

Item No.	Description	Mille/Box	Mille/Carton	Cartons/Pallet	KG/Carton
10300487	SKAM 320 NK	3	60.0	80	11.1
10300488	SKAM 325 NK	3	60.0	60	13.6
10300489	SKAM 332 NK	3	60.0	60	18.7
10300490	SKAM 338 NK	2	40.0	72	14.6
10300491	SKAM 345 NK	2	40.0	64	16.2
10300492	SKAM 350 NK	2	40.0	64	16.8



Item No.	Description	Fastener type	Length from - to in mm	Capacity/Pieces	Weight (net)
12100427	SK 464-343 C Contact Actuation with case	SK 400	25 - 64	100	1.5 kg



12000256	SK 451-717 C Contact Actuation	SK 400	25 - 51	97	2.2 kg
----------	--------------------------------	--------	---------	----	--------

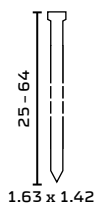

Item No.	Description	Mille/Box	Mille/Carton	Cartons/Pallet	KG/Carton
10300633	SK 425 NK	2	36.0	54	13.9
10300634	SK 432 NK	2	36.0	54	18.0
10300635	SK 435 NK	2	24.0	54	13.2
10300636	SK 438 NK	2	24.0	54	14.9
10300637	SK 445 NK	2	24.0	54	16.9
10300638	SK 450 NK	2	24.0	54	18.1
10300716	SK 464 NK	2	16.0	40	12.2
10300340	SK 438 NR A4	2	24.0	54	15.1

## BeA Brad Nailers



Item No.	Description	Fastener type	Length from - to in mm	Capacity/Pieces	Weight (net)
12100293	SKAM 450-227 C Contact Actuation with case	SKAM 400	25 - 50	100	1.4 kg

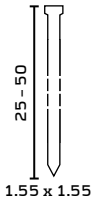

Item No.	Description	Mille/Box	Mille/Carton	Cartons/Pallet	KG/ Carton
10300518	SKAM 432 NK	5	20.0	90	11.2
10300519	SKAM 438 NK	5	20.0	90	12.8
10300520	SKAM 445 NK	5	20.0	72	15.2
10300521	SKAM 450 NK	5	20.0	64	16.7

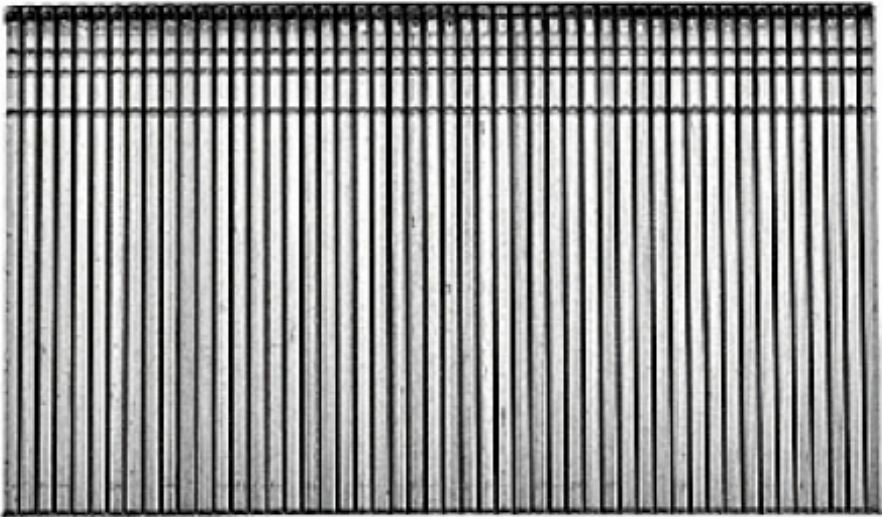

## BeA Brad Nailers



Item No.	Description	Fastener type	Length from - to in mm	Capacity/Pieces	Weight (net)
12100345	SKDA 663-771 C Contact Actuation with case	SKDA 600	32 - 63	100	1.9 kg

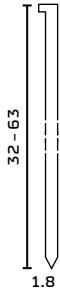

Item No.	Description	Mille/Box	Mille/Carton	Cartons/Pallet	KG/Carton
10300397	SKDA 632 NK HZ	4	16.0	56	11.7
10300398	SKDA 638 NK HZ	4	16.0	56	13.3
10300399	SKDA 644 NK HZ	4	16.0	56	15.4
10300400	SKDA 650 NK HZ	4	16.0	56	17.9
10300401	SKDA 656 NK HZ	4	16.0	56	21.0
10300402	SKDA 663 NK HZ	4	16.0	56	21.8
10300405	SKDA 638 RF HZ A2	4	16.0	56	13.3
10300407	SKDA 650 RF HZ A2	4	16.0	56	17.9
10300409	SKDA 663 RF HZ A2	4	16.0	56	21.8



Item No.	Description	Fastener type	Length from - to in mm	Capacity/Pieces	Weight (net)
12100331	SKS 650-228 C Contact Actuation with case	Steel Nails SKS 600	18 - 50	77	1.5 kg

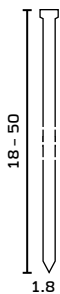

Item No.	Description	Mille/Box	Mille/Carton	Cartons/Pallet	KG/Carton
10300550	SKS 618 NK Steel	3	30.0	76	12.8
10300551	SKS 620 NK Steel	3	30.0	88	12.3
10300552	SKS 625 NK Steel	3	30.0	64	15.3
10300553	SKS 630 NK Steel	3	30.0	56	18.4
10300555	SKS 640 NK Steel	1.5	15.0	80	12.7
10300557	SKS 650 NK Steel	1.5	15.0	64	15.7

For information  
[www.bea-group.com](http://www.bea-group.com)  
 or call +49 (0)4102 78-445



# BeA T Nailers



Item No.	Description	Fastener type	Length from - to in mm	Capacity/ Pieces	Weight (net)
12000244	T 25-155 Contact Actuation also available with RapidClip attachment	T	13 - 25	82	2.7 kg
12000243	T 54-155 Contact Actuation also available with RapidClip attachment	T	25 - 54	82	2.7 kg

Item No.	Description	Mille/ Box	Mille/ Carton	Cartons/ Pallet	KG/ Carton
10200257	T 15 NKS	1.0	20.0	45	10.0
10200258	T 18 NKS	1.0	20.0	45	13.0
10200042	T 21 NKS	1.0	10.0	140	8.0
10200259	T 25 NKS	1.0	20.0	45	18.0
10200260	T 32 NKS	2.0	20.0	50	21.0
10200199	T 38 NKS	1.0	10.0	54	13.0
10200261	T 32 NK	1.0	10.0	54	11.0
10200247	T 38 NK	1.0	10.0	54	14.0
10200246	T 44 NK	1.0	10.0	54	16.0
10200242	T 50 NK	1.0	10.0	54	17.0
10200245	T 54 NK	1.0	10.0	45	18.0
10200244	T 62 NK	1.0	10.0	36	20.0

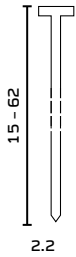

## BeA Nailers for Corrugated Fasteners

Item No.	Description	Fastener type	Length from - to in mm	Capacity/ Pieces	Weight (net)
	12000126 WM 12-156 C Contact Actuation	WM	6 - 12	75	2.8 kg

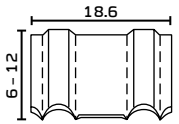

Item No.	Description	Mille/ Carton	Cartons/ Pallet	KG/ Carton
10800000	WM 06 BK A	17.3	85	7.5
10800002	WM 09 BK A	11.5	85	7.9
10800004	WM 12 BK A	8.6	85	8.2

Item No.	Description	Fastener type	Length from - to in mm	Capacity/ Pieces	Weight (net)
	12000660 W 15-788 C Contact Actuation	W	9 - 15	77	3.0 kg

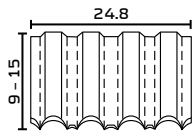

Item No.	Description	Mille/ Carton	Cartons/ Pallet	KG/ Carton
10800007	W 09 BK A	9.2	85	8.4
10800014	W 12 BK A	6.9	85	8.7
10800021	W 15 BK A	5.2	85	8.6

Item No.	Description	Fastener type	Length from - to in mm	Capacity/ Pieces	Weight (net)
	12000610 W 25-826 E Single Actuation	Maxi W	18 - 25	80	3.7 kg

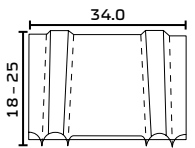

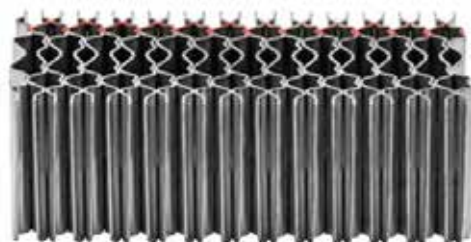

Item No.	Description	Mille/ Carton	Cartons/ Pallet	KG/ Carton
10800043	W 18 BK Maxi	2.7	85	5.4
10800039	W 25 BK Maxi	1.9	85	7.5



## BeA Coil Nailers for Nail type BDC

	Item No.	Description		Fastener type	Length from - to in mm	Capacity/Pieces	Weight (net)
	12100673	DC/55-572C Contact Actuation		BDC	30 - 55 Ø 2.1 - 2.4	1 Coil	2.6 kg
	12200099	570 DC Two Hand Actuation		BDC	25 - 57 Ø 2.1 - 2.5	1 Coil	3.6 kg
	12100510	564 DC Contact Actuation		BDC	38 - 65 Ø 2.1 - 2.9	1 Coil	2.7 kg
	12100667	DC/70-702C Contact Actuation		BDC	42 - 70 Ø 2.2 - 2.8	1 Coil	3.6 kg
	12100670	DC/80-802C Contact Actuation		BDC	50 - 80 Ø 2.5 - 3.1	1 Coil	3.8 kg
	12100696	DC/90-902C Contact Actuation		BDC	50 - 90 Ø 2.5 - 3.4	1 Coil	3.6 kg
	12100691	DC/100-1002C Contact Actuation		BDC	65 - 100 Ø 2.5 - 3.4	1 Coil	5.6 kg
	12200100	102 DC Two Hand Actuation		BDC	55 - 100 Ø 2.5 - 3.8	1 Coil	7.2 kg
	12100689	DC/130-1302E Single Shot Actuation		BDC	90 - 130 Ø 3.3 - 3.8	1 Coil	6.0 kg
	14404669	Tool Balancer					
	14001692	Balancer M6 - 500mm (Set a 2 pcs.)					
	14001740	Balancer M8 - 500mm (Set a 2 pcs.)					
	14414191	Second handle for DC/55-572C					
	14414192	Second handle for DC/70-702C + DC/80-802C					

## BeA Coil Nailers for Nail type BDC

	Item No.	Description	Fastener type	Length from - to in mm	Capacity/Pieces	Weight (net)
	12200110	DC/80-802C Two Hand	BDC	50 - 80	1 Coil	5.7 kg
	12200111	DC/80-802C Two Hand light	BDC	50 - 80	1 Coil	5.5 kg

## BeA Skater for Nail type BDC

	Item No.	Description	Fastener type	Length from - to in mm	Capacity/Pieces	Weight (net)
	12000666*	Skater DC/90-902C	BDC	50 - 80 Ø 2.5 - 3.1	1 Coil	2.8 kg

\* Tool without Skater base - fits with Skater base 14412430 (standard distances and 14414707 (short distances)

### Item No. Accessories for Skater

14414707	Skater (short distances 30/60mm; 45/90mm; 90/180mm) basis without tool
14412430	Skater (standard distances) basis without tool
14412428	Edge guide
14412429	Extension handle
14406482	Rail 3.0 m (in connection with edge guide)
14409063	Rail 3.5 m (in connection with edge guide)
14412767	Rail guide set for Festool rail



## BeA Coil Nailers for Nail type BDC

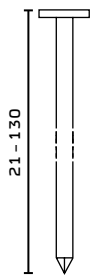

Item No.	Description	Mille/ Carton	Cartons/ Pallet	KG/ Carton
10500628	BDC 2.1x35 BK	14.7	40	13.6
10500637	BDC 2.1x40 BK	12.6	40	13.3
10500644	BDC 2.1x45 BK	12.6	40	15.0
10500650	BDC 2.1x50 BK	10.5	40	13.8
10500479	BDC 2.1x40 BK Clinch	12.6	40	15.2
10500394	BDC 2.1x45 BK Clinch	12.6	40	15.0
10500419	BDC 2.1x27 BK Ring	16.8	40	11.8
10500619	BDC 2.1x30 BK Ring	16.8	40	13.4
10500625	BDC 2.1x32 BK Ring	16.8	40	14.3
10500629	BDC 2.1x35 BK Ring	14.7	40	13.6
10500634	BDC 2.1x38 BK Ring	14.7	40	14.8
10500639	BDC 2.1x40 BK Ring	12.6	40	13.3
10500646	BDC 2.1x45 BK Ring	12.6	40	15.0
10500652	BDC 2.1x50 BK Ring	10.5	40	13.8
10500656	BDC 2.1x55 BK Ring	10.5	40	18.2
10500642	BDC 2.1x40 NK Ring	12.6	40	13.3
10500653	BDC 2.1x50 NK Ring	10.5	40	13.8
10501717	BDC 2.3x40 BK Ring	12.0	40	16.4
10501718	BDC 2.3x45 BK Ring	12.0	40	17.2
10501719	BDC 2.3x50 BK Ring	10.0	40	15.9
10500397	BDC 2.3x55 BK	10.0	40	17.4
10501714	BDC 2.3x60 BK	8.0	40	15.2
10501720	BDC 2.3x55 BK Ring	10.0	40	17.4
10501724	BDC 2.5x42 BK Ring	10.8	40	17.8
10500382	BDC 2.5x45 BK	10.8	40	19.1
10500429	BDC 2.5x50 BK	9.0	40	16.8
10500430	BDC 2.5x55 BK	9.0	40	18.4
10500431	BDC 2.5x60 BK	7.2	40	11.3
10500141	BDC 2.5x65 BK	7.2	40	12.2
10500156	BDC 2.5x70 BK	7.2	40	18.0
10500434	BDC 2.5x45 BK Ring	10.8	40	19.1
10500435	BDC 2.5x50 BK Ring	9.0	40	16.8
10500458	BDC 2.5x50 NK Ring	9.0	40	16.8
10500436	BDC 2.5x55 BK Ring	9.0	40	18.4
10500487	BDC 2.5x57 BK Ring	7.2	40	15.5
10500437	BDC 2.5x60 BK Ring	7.2	40	13.0
10500146	BDC 2.5x65 BK Ring	7.2	40	14.0
10500160	BDC 2.5x70 BK Ring	7.2	40	18.0
10500457	BDC 2.5x45 NK Ring	10.8	40	19.1
10500459	BDC 2.5x55 NK Ring	9.0	40	18.4
10500460	BDC 2.5x60 NK Ring	7.2	40	18.1
10500259	BDC 2.5x65 NK	7.2	40	17.8
10501271	BDC 2.5x65 NK Ring	7.2	40	19.5
10500690	BDC 2.5x65 FV Ring	7.2	40	17.4
10501494	BDC 2.5x65 NR Ring A4 LK	7.2	40	17.5
10500122	BDC 2.8x60 BK	6.0	40	18.0
10500144	BDC 2.8x65 BK	6.0	40	18.8



All above mentioned BDC Nails (except Clinch) have the required characteristics specified in Eurocode 5.  
Further information on page 4





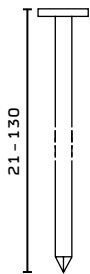

## BeA Coil Nailers for Nail type BDC

Item No.	Description	Mille/ Carton	Cartons/ Pallet	KG/ Carton
10501259	BDC 2.8x70 BK	6.0	40	20.0
10500173	BDC 2.8x75 BK	4.5	40	16.8
10500183	BDC 2.8x80 BK	4.5	40	17.1
10500126	BDC 2.8x60 BK Ring	6.0	40	18.0
10501258	BDC 2.8x65 BK Ring	6.0	40	18.8
10500161	BDC 2.8x70 BK Ring	6.0	40	20.0
10500176	BDC 2.8x75 BK Ring	4.5	40	16.8
10500186	BDC 2.8x80 BK Ring	4.5	40	17.1
10501183	BDC 2.8x90 BK Ring	4.5	40	20.1
10500957	BDC 2.8x65 BK Screw	6.0	40	19.2
10501159	BDC 2.8x70 BK Screw	6.0	40	20.5
10501261	BDC 2.8x75 BK Screw	4.5	40	16.8
10500188	BDC 2.8x80 BK Screw	4.5	40	17.1
10501260	BDC 2.8x70 NK	6.0	40	20.0
10500138	BDC 2.8x65 NK Ring	6.0	40	18.8
10500155	BDC 2.8x70 NK Ring	6.0	40	20.0
10501162	BDC 2.8x75 NK Ring	4.5	40	16.8
10502209	BDC 2.8x65 NK Screw TX	6.0	40	19.7
10502225	BDC 2.8x80 NK Screw TX	3.96	40	15.6
10501546	BDC 2.8x65 NR Ring A4 LK	6.0	40	18.8
10501496	BDC 2.8x70 NR Ring A4 LK	6.0	40	20.0
10501497	BDC 2.8x80 NR Ring A4 LK	4.5	40	17.6
10501247	BDC 3.1x70 BK	4.8	40	19.4
10500184	BDC 3.1x80 BK	3.6	40	17.6
10500198	BDC 3.1x90 BK	3.6	40	19.8
10501248	BDC 3.1x70 BK Ring	4.8	40	19.4
10501511	BDC 3.1x80 BK Ring	3.6	40	17.6
10500201	BDC 3.1x90 BK Ring	3.6	40	19.8
10500189	BDC 3.1x80 BK Screw	3.6	40	17.5
10500202	BDC 3.1x90 BK Screw	3.6	40	19.8
10500314	BDC 3.1x70 NK	4.8	40	20.7
10501251	BDC 3.1x80 NK	3.6	40	17.1
10501254	BDC 3.1x90 NK	3.6	40	18.9
10501252	BDC 3.1x80 NK Ring	3.6	40	16.6
10501255	BDC 3.1x90 NK Ring	3.6	40	18.4
10501533	BDC 3.1x90 NR Ring A4 LK	3.6	40	18.9
10501776	BDC 3.8x110 BK	1.8	40	20.2
10501773	BDC 3.8x120 BK	1.8	40	21.6
10501785	BDC 3.8x130 BK	1.8	40	23.4
10501769	BDC 3.8x120 BK Ring	1.8	40	22.2
10501811	BDC 3.8x130 BK Ring	1.8	40	23.9
10501790	BDC 3.8x120 BK Screw	1.8	40	22.2
10501792	BDC 3.8x130 BK Screw	1.8	40	23.9
10500315	BDC 3.8x120 NK Ring	1.8	40	22.2
10501830	BDC 3.8x130 NK Ring	1.8	40	23.9



All above mentioned BDC Nails (except Clinch) have the required characteristics specified in Eurocode 5 and EN 14592. Further information on page 4

BeA Coil Nailers for Nail types BDC and TC

Item No.	Description	Fastener type	Length from - to in mm	Capacity/Pieces	Weight (net)
 12100648	557 DC Contact Actuation with case	BDC + TC	32 - 50 TC + BDC Ø 2.1 - 2.5	1 Coil	2.0 kg
 12100458	567 DC Contact Actuation (Single actuation on request)	BDC + TC	32 - 65 BDC Ø 2.1 - 2.5 TC Ø 2.2 - 2.5	1 Coil	2.1 kg
 12100635	780 DCC Contact Actuation	BDC+TC	45 - 70 BDC Ø 2.5 - 3.3 TC Ø 2.3 - 2.5	1 Coil	2.9 kg
 12100470	903 DC Contact Actuation (Single actuation on request) with case	BDC + TC	BDC 45 - 90 Ø 2.5 - 3.8 TC 45 - 75 Ø 2.5 - 3.0	1 Coil	3.0 kg
14404669	Tool Balancer				



depth adjustment

## BeA Coil Nailers for Nail types BDC and TC

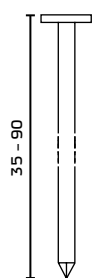

Item No.	Description	Mille/ Carton	Cartons/ Pallet	KG/ Carton
10500628	BDC 2.1x35 BK	14.7	40	13.6
10500637	BDC 2.1x40 BK	12.6	40	13.3
10500644	BDC 2.1x45 BK	12.6	40	15.0
10500650	BDC 2.1x50 BK	10.5	40	13.8
10500479	BDC 2.1x40 BK Clinch	12.6	40	15.2
10500394	BDC 2.1x45 BK Clinch	12.6	40	15.0
10500419	BDC 2.1x27 BK Ring	16.8	40	11.8
10500619	BDC 2.1x30 BK Ring	16.8	40	13.4
10500625	BDC 2.1x32 BK Ring	16.8	40	14.3
10500629	BDC 2.1x35 BK Ring	14.7	40	13.6
10500634	BDC 2.1x38 BK Ring	14.7	40	14.8
10500639	BDC 2.1x40 BK Ring	12.6	40	13.3
10500646	BDC 2.1x45 BK Ring	12.6	40	15.0
10500652	BDC 2.1x50 BK Ring	10.5	40	13.8
10500656	BDC 2.1x55 BK Ring	10.5	40	18.2
10500642	BDC 2.1x40 NK Ring	12.6	40	13.3
10500653	BDC 2.1x50 NK Ring	10.5	40	13.8
10501717	BDC 2.3x40 BK Ring	12.0	40	16.4
10501718	BDC 2.3x45 BK Ring	12.0	40	17.2
10501719	BDC 2.3x50 BK Ring	10.0	40	15.9
10500397	BDC 2.3x55 BK	10.0	40	17.4
10501714	BDC 2.3x60 BK	8.0	40	15.2
10501720	BDC 2.3x55 BK Ring	10.0	40	17.4
10501724	BDC 2.5x42 BK Ring	10.8	40	17.8
10500382	BDC 2.5x45 BK	10.8	40	19.1
10500429	BDC 2.5x50 BK	9.0	40	16.8
10500430	BDC 2.5x55 BK	9.0	40	18.4
10500431	BDC 2.5x60 BK	7.2	40	11.3
10500141	BDC 2.5x65 BK	7.2	40	12.2
10500156	BDC 2.5x70 BK	7.2	40	18.0
10500434	BDC 2.5x45 BK Ring	10.8	40	19.1
10500435	BDC 2.5x50 BK Ring	9.0	40	16.8
10500458	BDC 2.5x50 NK Ring	9.0	40	16.8
10500436	BDC 2.5x55 BK Ring	9.0	40	18.4
10500487	BDC 2.5x57 BK Ring	7.2	40	15.5
10500437	BDC 2.5x60 BK Ring	7.2	40	13.0
10500146	BDC 2.5x65 BK Ring	7.2	40	14.0
10500160	BDC 2.5x70 BK Ring	7.2	40	18.0
10500457	BDC 2.5x45 NK Ring	10.8	40	19.1
10500459	BDC 2.5x55 NK Ring	9.0	40	18.4
10501490	BDC 2.5x55 NR Ring A4 LK	9.0	40	18.4
10500460	BDC 2.5x60 NK Ring	7.2	40	18.1
10500259	BDC 2.5x65 NK	7.2	40	17.8
10500173	BDC 2.8x75 BK	4.5	40	16.8
10500183	BDC 2.8x80 BK	4.5	40	17.1
10500126	BDC 2.8x60 BK Ring	6.0	40	18.0



All above mentioned BDC Nails (except Clinch) have the required characteristics specified in Eurocode 5 and EN 14592. Further information on page 4

## BeA Coil Nailers for Nail types BDC and TC

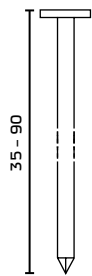

Item No.	Description	Mille/ Carton	Cartons/ Pallet	KG/ Carton
10501258	BDC 2.8x65 BK Ring	6.0	40	18.8
10500161	BDC 2.8x70 BK Ring	6.0	40	20.0
10500176	BDC 2.8x75 BK Ring	4.5	40	16.8
10500186	BDC 2.8x80 BK Ring	4.5	40	17.1
10501183	BDC 2.8x90 BK Ring	4.5	40	20.1
10500957	BDC 2.8x65 BK Screw	6.0	40	19.2
10501159	BDC 2.8x70 BK Screw	6.0	40	20.5
10501261	BDC 2.8x75 BK Screw	4.5	40	16.8
10500188	BDC 2.8x80 BK Screw	4.5	40	17.1
10501260	BDC 2.8x70 NK	6.0	40	20.0
10500138	BDC 2.8x65 NK Ring	6.0	40	18.8
10500155	BDC 2.8x70 NK Ring	6.0	40	20.0
10501162	BDC 2.8x75 NK Ring	4.5	40	16.8
10502209	BDC 2.8x65 NK Screw TX	6.0	40	19.7
10502225	BDC 2.8x80 NK Screw TX	3.96	40	15.6
10501546	BDC 2.8x65 NR Ring A4 LK	6.0	40	18.8
10501496	BDC 2.8x70 NR Ring A4 LK	6.0	40	20.0
10501497	BDC 2.8x80 NR Ring A4 LK	4.5	40	17.6
10500138	BDC 2.8x65 NK Ring	6.0	40	18.8
10500155	BDC 2.8x70 NK Ring	6.0	40	20.0
10501247	BDC 3.1x70 BK	4.8	40	19.4
10500184	BDC 3.1x80 BK	3.6	40	17.6
10500198	BDC 3.1x90 BK	3.6	40	19.8
10501248	BDC 3.1x70 BK Ring	4.8	40	19.4
10501511	BDC 3.1x80 BK Ring	3.6	40	17.6
10500201	BDC 3.1x90 BK Ring	3.6	40	19.8
10500189	BDC 3.1x80 BK Screw	3.6	40	17.5
10500202	BDC 3.1x90 BK Screw	3.6	40	19.8
10500314	BDC 3.1x70 NK	4.8	40	20.7
10501251	BDC 3.1x80 NK	3.6	40	17.1
10501254	BDC 3.1x90 NK	3.6	40	18.9
10501252	BDC 3.1x80 NK Ring	3.6	40	16.6
10501255	BDC 3.1x90 NK Ring	3.6	40	18.4
10501533	BDC 3.1x90 NR Ring A4 LK	3.6	40	18.9



All above mentioned BDC Nails have the required characteristics specified in Eurocode 5 and EN 14592.  
Further information on page 4

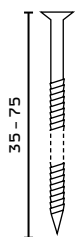





Item No.	Description	Mille/ Carton	Cartons/ Pallet	KG/ Carton
10600029	TC-NG 2.0x35 NK PZ	8.0	28	11.0
10600031	TC-NG 2.5x40 NK PZ	8.0	28	12.6
10600196	TC-NG 2.5x40 NK TX	8.0	28	12.6
10600245	TC-NG 2.5x45 NK TX	8.0	28	14.7
10600246	TC-NG 2.5x50 NK TX	8.0	28	15.7
10600045	TC-FAS 2.3x37 NR Ring A2	3.2	105	3.9



All above mentioned TC Nails have the required characteristics specified in Eurocode 5 and EN 14592.  
Further information on page 4

## BeA Coil Nailers for EPAL Nails

Item No.	Description	Fastener type	Length from - to in mm	Capacity/Pieces	Weight (net)
	12100667 DC/70-702C Contact Actuation 	BDC	42 - 70 Ø 2.2 - 2.8	1 Epal-Coil	3.6 kg
	12100692 DC/100-1002C Epal Contact Actuation 	EPAL-Coil nails	70 - 90 Ø 3.4	1 Epal-Coil	5.6 kg

Item No.	Description	Mille/ Carton	Cartons/ Pallet	KG/ Carton
10500370	BDC 3.0x40 BK Ring EPAL	8.1	40	16.6
10500342	BDC 3.4x70 BK Ring EPAL	4.3	30	19.0
10502124	BDC 3.3x90 BK Ring EPAL	3.2	40	17.8

Certified by the European Pallet Association (EPAL)

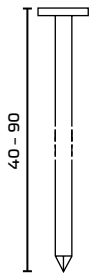

## BeA Recipro Saber Saw Blades

Item No.	Description	Dimension in mm	Teething	Tip
11700001	Recipro 200x0.9x19 VTNT	200x0.9x19	Vario Teething (10-14 TPI)	Normal Sharp Tip
11700002	Recipro 230x0.9x19 VTNT	230x0.9x19	Vario Teething (10-14 TPI)	Normal Sharp Tip
11700003	Recipro 200x1.25x19 VTNT	200x1.25x19	Vario Teething (10-14 TPI)	Normal Sharp Tip
11700004	Recipro 230x1.25x19 VTNT	230x1.25x19	Vario Teething (10-14 TPI)	Normal Sharp Tip
11700011	Recipro 230x0.9x19 WTNT	230x0.9x19	Wood Teething (10 TPI)	Normal Sharp Tip
11700018	Recipro 190x1.25x19 VVRT	190x1.25x19	Vario Teething (10-14 TPI)	Reverse Sharp Tip
11700020	Recipro 200x0.9x19 WTNT	200x0.9x19	Wood Teething (10 TPI)	Normal Sharp Tip
11700021	Recipro 200x1.25x19 WTNT	200x1.25x19	Wood Teething (10 TPI)	Normal Sharp Tip
11700023	Recipro 190x0.9x19 VVRT	190x0.9x19	Vario Teething (10-14 TPI)	Reverse Sharp Tip
11700024	Recipro 225x0.9x19 VVRT	225x0.9x19	Vario Teething (10-14 TPI)	Reverse Sharp Tip
11700025	Recipro 225x1.25x19 VVRT	225x1.25x19	Vario Teething (10-14 TPI)	Reverse Sharp Tip
11700026	Recipro 228x1x18.4 VVRT	228x1x18.4	Carbide Teething (8TPI) <b>NEW</b>	Reverse Sharp Tip





## BeA Coil Nailers for Roofing Nails



Item No.	Description	Fastener type	Length from - to in mm	Capacity/Pieces	Weight (net)
12100609	556 DC Contact Actuation with case	DPN	19 - 45 Ø 3.1	1 Coil	2.3 kg



Item No.	Description	Mille/ Carton	Cartons/ Pallet	KG/ Carton
10500001	DPN 3.1x19 NK	7.2	36	10.0
10500004	DPN 3.1x22 NK	7.2	36	10.7
10500007	DPN 3.1x25 NK	7.2	36	12.9
10500010	DPN 3.1x32 NK	7.2	36	14.7
10500013	DPN 3.1x38 NK	7.2	24	18.2
10500016	DPN 3.1x45 NK	7.2	24	21.9
10500002	DPN 3.1x19 FV	7.2	36	10.0
10500005	DPN 3.1x22 FV	7.2	36	10.7
10500008	DPN 3.1x25 FV	7.2	36	12.9
10500011	DPN 3.1x32 FV	7.2	36	14.7
10500014	DPN 3.1x38 FV	7.2	24	18.2
10500595	DPN 3.1x19 NK Ring	7.2	36	10.5
10500596	DPN 3.1x22 NK Ring	7.2	36	11.3
10500597	DPN 3.1x25 NK Ring	7.2	36	13.3
10500623	DPN 3.1x32 NK Ring	7.2	36	15.1

## Plastic Collated Nails for CN 450 G - art. no. 12100241

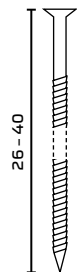

Item No.	Description	Mille/ Carton	Cartons/ Pallet	KG/ Carton
<b>Plasterboard Nails</b>				
10600314	TC-NG GK 22x30 NK Ring*	10.8	40	9.7
<b>Nail Screws with Recessed Phillips Head</b>				
10600146	TC 2.0x26 NK Screw PZ	8.0	40	7.2
10600025	TC 2.5x26 NK Screw PZ	8.0	28	7.4
10600027	TC 2.5x30 NK Screw PZ	8.0	28	9.4
10600029	TC 2.5x35 NK Screw PZ	8.0	28	11.0
10600031	TC 2.5x40 NK Screw PZ	8.0	28	8.8
10600196	TC 2.5x40 NK Screw TX	8.0	28	12.6
<b>Copper Roofing Pins</b>				
10600262	TC 2.6/2.8x26 A2 Copper Roofing Nails	3.6	100	5.9
<b>Slate Pins</b>				
10600115	TC 2.8x35 FV Slate	3.2	105	6.5
10600263	TC 2.8x35 A2 Ring Slate	3.6	100	7.3
<b>Facade Nails</b>				
10600045	TC 2.3x37 A2 Ring Dark Grey	3.2	105	3.8

\* Conforms to DIN 18182 Part 2

## BeA Anchor Nailer for Nail type TC - Plastic Collated



Item No.	Description	Fastener type	Length from - to in mm	Capacity/Pieces	Weight (net)
12100506	AN 560 TC Single Actuation with case	TC Anchor Nails	40 - 60 Ø 4.0	1 Coil	2.3 kg



Item No.	Description	Mille/Bucket	Bucket/Pallet	KG/Bucket
10600195	TC Anchor Nails 4.0x40 NK Ring	2.0	60	8.6
10600296	TC Anchor Nails 4.0x50 NK Ring	2.0	60	11.2
10600514	TC Anchor Nails 4.0x60 NK Ring	2.0	60	10.7

Collating angle = 16°. Not for use in BeA Multifix TC 300

All above mentioned Anchor Nails have the required characteristics specified in Eurocode 5 and EN 14592. Further information on page 4

## BeA Anchor Nailer for Nail type R25 - Plastic Collated



Item No.	Description	Fastener type	Length from - to in mm	Capacity/Pieces	Weight (net)
12100436	R 60-943 E Single Actuation with case	R25 Anchor Nails	40 - 60 Ø 4.0	28	2.5 kg

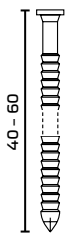

Item No.	Description	Mille/Bucket	Bucket/Pallet	KG/Bucket
10401172	R25 4.0x40 NK Ring	1.0	84	4.6
10401173	R25 4.0x50 NK Ring	1.0	84	5.4
10401174	R25 4.0x60 NK Ring	1.0	84	6.3

All above mentioned Anchor Nails have the required characteristics specified in Eurocode 5 and EN 14592. Further information on page 4

Anchor Nails in versatile plastic bucket



## BeA Anchor Nailer for Nail type R34 – Plastic Collated

Item No.	Description	Fastener type	Length from - to in mm	Capacity/ Pieces	Weight (net)	
	12100507	AN R60-34° E Single Actuation	R34 Anchor Nails	40 - 60 Ø 4.0	25	2.3 kg



Item No.	Description	Mille/ Bucket	Bucket/ Pallet	KG/ Bucket
10401267	R34 4.0x40 NK Ring	1.25	84	5.6
10401268	R34 4.0x50 NK Ring	1.25	84	7.2
10401269	R34 4.0x60 NK Ring	1.25	84	8.3

All above mentioned Anchor Nails have the required characteristics specified in Eurocode 5 and EN 14592. Further information on page 4

### Anchor Nails for Multifix TC300



Item No.	Description	Mille/ Carton	Cartons/ Pallet	KG/ Carton
10600064	TC 4.0x40 NK Ring Anchor Nails	3.0	40	13.1
10600065	TC 4.0x50 NK Ring Anchor Nails	2.4	40	12.3
10600066	TC 4.0x60 NK Ring Anchor Nails	2.4	40	14.5
10600067	TC 4.0x75 NK Ring Anchor Nails	1.8	40	15.3

All above mentioned Anchor Nails have the required characteristics specified in Eurocode 5 and EN 14592. Further information on page 4



Please ask for our detailed HVV timber connector catalogue



## BeA Strip Nailers for Paper Collated D Head Nails

Item No.	Description	Fastener type	Length from - to in mm	Capacity/ Pieces	Weight (net)	
	12100234	D 100-934 C Contact Actuation (Single actuation on request) with case	Paper Collated D Head Nails	50 - 100 Ø 2.9 - 3.4	90	3.5 kg

## BeA Strip Nailers for Paper Collated D Head Nails

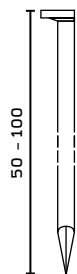

Item No.	Description	Mille/ Carton	Cartons/ Pallet	KG/ Carton
10400817	D34 2.9x65 BK	5.0	48	17.9
10400561	D34 2.9x70 BK	5.0	48	19.2
10400775	D34 2.9x76 BK	4.0	48	16.6
10400626	D34 2.9x80 BK	3.0	48	13.3
10400562	D34 3.1x83 BK	3.0	48	15.3
10400563	D34 3.1x90 BK	3.0	48	16.5
10400564	D34 3.4x90 BK	3.0	48	19.8
10400565	D34 3.4x100 BK	3.0	48	21.9
10400820	D34 2.9x65 NK	5.0	48	17.9
10400630	D34 2.9x70 NK	5.0	48	19.6
10400567	D34 3.1x83 NK	3.0	48	15.3
10400568	D34 3.1x90 NK	3.0	48	16.5
10400570	D34 3.4x100 NK	3.0	48	21.9
10400571	D34 2.9x50 BK Ring	6.6	48	18.4
10400818	D34 2.9x65 BK Ring	5.0	48	17.9
10400589	D34 2.9x70 BK Ring	5.0	48	19.3
10400573	D34 2.9x76 BK Ring	4.0	48	16.6
10400776	D34 2.9x80 BK Ring	3.0	48	13.3
10400574	D34 3.1x83 BK Ring	3.0	48	15.3
10400575	D34 3.1x90 BK Ring	3.0	48	16.5
10400576	D34 3.1x100 BK Ring	3.0	48	18.9
10400821	D34 2.9x65 NK Ring	5.0	48	17.9
10400746	D34 2.9x76 NK Ring	4.0	48	16.8
10401342	D34 2.9x80 NK Ring	3.0	48	13.8
10400578	D34 3.1x83 NK Ring	3.0	48	15.3
10400597	D34 3.1x90 NK Ring	3.0	48	17.0
10400627	D34 3.1x90 FV	3.0	48	17.4
10400579	D34 2.9x50 FV Ring	6.6	48	19.3
10400819	D34 2.9x65 FV Ring	5.0	48	18.3
10400581	D34 2.9x76 FV Ring	4.0	48	17.4
10400582	D34 3.1x90 FV Ring	3.0	48	17.4
10400583	D34 3.1x100 FV Ring	3.0	48	19.9



All above mentioned D Head Nails have the required characteristics specified in Eurocode 5 and EN 14592.  
Further information provided on page 4

## BeA Strip Nailers for plastic collated Nails

Item No.	Description	Fastener type	Length from - to in mm	Capacity/Pieces	Weight (net)
12100292	R100-952 C Contact Actuation (Single actuation on request) with case	Nails R 20	50 - 100 Ø 2.8 - 3.4	70	3.7 kg

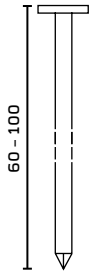





Item No.	Description	Mille/ Carton	Cartons/ Pallet	KG/ Carton
10400015	R20 2.8x60 BK	3.0	60	9.0
10400020	R20 2.8x65 BK	3.0	60	9.8
10400029	R20 2.8x70 BK	3.0	60	10.5
10400022	R20 2.8x65 BK Ring	3.0	60	10.3
10401341	R20 2.8x80 BK Ring	3.0	60	15.2
10400030	R20 3.1x70 BK	3.0	60	12.8
10400044	R20 3.1x80 BK	3.0	60	14.7
10400054	R20 3.1x90 BK	3.0	60	16.5
10400032	R20 3.1x70 BK Screw	3.0	60	12.8
10400047	R20 3.1x80 BK Screw	3.0	60	14.7
10400055	R20 3.1x90 BK Screw	3.0	60	16.5
10400041	R20 3.1x80 NK	3.0	60	14.7
10400051	R20 3.1x90 NK	3.0	60	16.5
10400053	R20 3.1x90 NK Screw	3.0	60	16.5
10401635	R20 3.4x100 BK	1.5	60	10.4
10401636	R20 3.4x100 NK	1.5	50	10.4

All above mentioned D Head Nails have the required characteristics specified in Eurocode 5 and EN 14592. Further information on page 4





## BeA Strip Nailers for plastic collated Nails

	Item No.	Description	Fastener type	Length from - to in mm	Capacity/Pieces	Weight (net)
	12000597	R 130-957 E Single Actuation	Nails R 20	80 - 130 Ø 3.1 - 4.2	65	6.4 kg
	12100694	R20/130-1303E Single Actuation	Nails R 20	100 - 130 Ø 3.8 - 4.6	65	6.1 kg
	12000601	R 160-962 E Single Actuation Full Sequential Actuation	Nails R 20	100 - 160 Ø 3.8 - 5.0	50	7.2 kg
	12100695	R20/160-1603E Single Actuation	Nails R 20	100 - 160 Ø 3.8 - 4.6	50	7.1 kg
	12000604	R 220-970 E Single Actuation Full Sequential Actuation	Nails R 20	145 - 220 Ø 4.6 - 5.0	40	8.5 kg

For information  
[www.bea-group.com](http://www.bea-group.com)  
 or call +49 (0)4102 78-445

## BeA Strip Nailers for plastic collated Nails

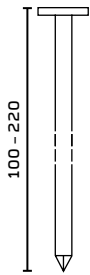

Item No.	Description	Mille/ Carton	Cartons/ Pallet	KG/ Carton
10400077	R20 3.8x100 BK	1.5	50	13.5
10400060	R20 3.8x110 BK	1.5	50	14.9
10400062	R20 3.8x120 BK	1.5	50	16.3
10400067	R20 3.8x130 BK	1.5	50	17.8
10400064	R20 3.8x120 BK Screw	1.5	50	16.3
10400463	R20 3.8x130 BK Screw	1.5	50	17.8
10400462	R20 3.8x130 BK Ring	1.5	50	17.8
10400197	R20 3.8X120 NK	1.5	50	16.7
10400065	R20 3.8x130 NK	1.5	50	17.8
10400068	R20 4.2x130 BK	1.5	50	21.6
10400402	R20 4.2x160 BK	0.7	60	11.4
10401340	R20 4.2x160 BK Screw	0.7	60	11.8
10400069	R20 4.6x145 BK	0.7	60	13.5
10400070	R20 4.6x160 BK	0.7	60	14.1
10401193	R20 4.6x180 BK Ring	0.6	44	13.5
10400464	R20 4.6x160 BK Screw	0.7	60	17.8
10401048	R20 5.0x180 BK	0.6	44	15.6
10401047	R20 5.0x200 BK	0.6	36	17.4
10401049	R20 4.6x220 BK	0.6	36	15.6
10400006	R20 4.6x160 NK	0.7	60	13.9

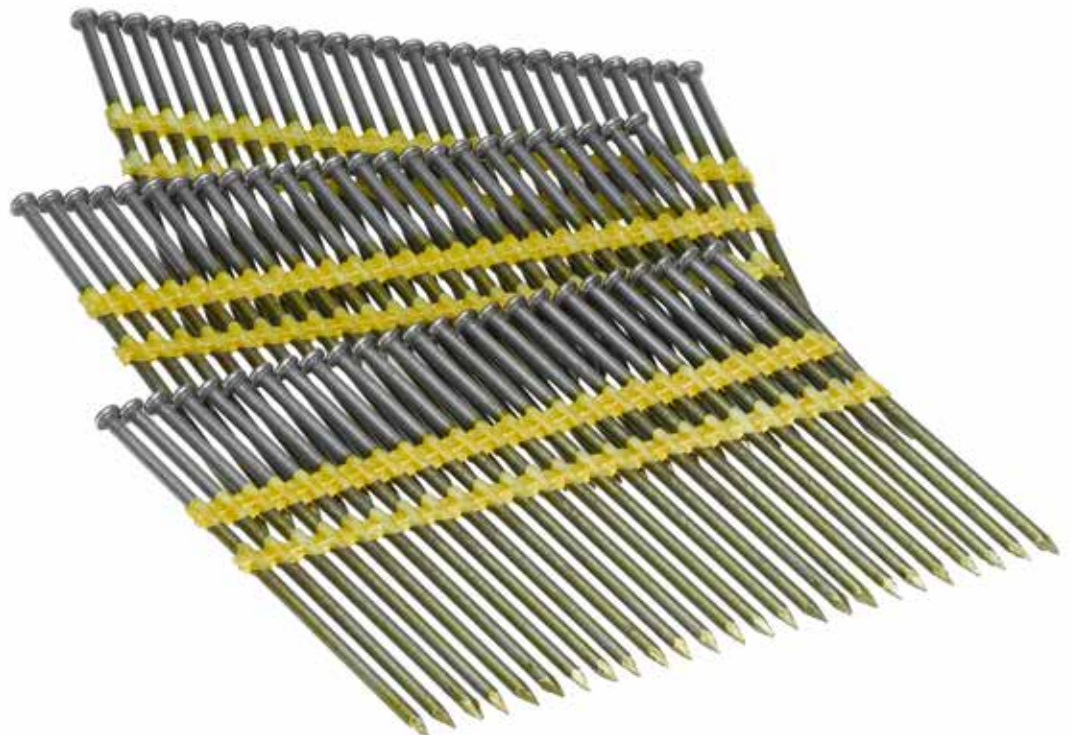

All above mentioned D Head Nails have the required characteristics specified in Eurocode 5 and EN 14592.  
Further information on page 4



## BeA RapidClip

Item No.	Description	Fastener type	Length from - to in mm	Capacity/Pieces	Weight (net)
	12000215 14/32-613 Contact Actuation	14 16 155	15 - 32	Type 14 110 Staples Type 16/155 102 Staples	1.4 kg
	12000344 14/40-723 C Contact Actuation	14 16 155	18 - 40	Type 14 159 Staples Type 16/155 149 Staples	2.2 kg
	12000244 T25-155 Contact Actuation	T	13 - 25	82 Nails	2.7 kg

For use with RapidClip - all the above listed tools must be equipped with the corresponding nose.

Item No.	Description	Mille/ Carton	Cartons/ Pallet	KG/ Carton
10004787	14/40 NK HZ*	10.0	84	10.3
10003386	14/45 NK HZ	10.0	75	11.5
10003387	14/50 NK HZ	10.0	75	12.9
10003352	16/40 NK HZ*	10.0	88	12.4
10002619	16/45 NK HZ*	10.0	80	13.6
10002620	16/50 NK HZ*	10.0	60	15.1
10003751	16/60 NK HZ*	10.0	54	18.7
10003693	16/65 NK HZ*	10.0	45	20.2
10003272	16/45 NK HZ	10.0	80	13.6
10003274	16/50 NK HZ	10.0	60	15.1
10000604	155/21 NK HZ CD	13.0	68	9.2
10004890	155/45 VZ HZ	10.0	80	13.6
10004838	155/50 VZ HZ	10.0	60	15.1
10002719	155/56 VZ HZ	10.9	54	20.2
10002177	155/65 VZ HZ	10.9	45	22.5
10000629	155/45 NR HZ A4	9.0	85	12.2
10002051	155/50 NR HZ A4	7.0	85	11.0

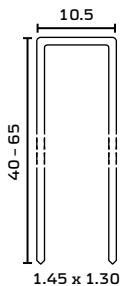

\* Conforms to EN14566 and DIN 18182 Part 2

Staple type 155 are approved with ETA and conform to the requirements of Eurocode 5.

Further information on page 4



## BeA RapidClip

For fastening sinuous springs in seats and upholstered furniture

<p><b>RapidClip F</b> for maximum spring tension of 22 kg</p>			
<p><b>RapidClip FW</b> for maximum spring tension of 26 kg for e.g wood, metal and frame</p>	<p><i>on wood</i></p>		<p><i>on a metal frame</i></p>
<p><b>RapidClip FWB</b> for maximum spring tension of 15 kg for back springing</p>			
<p><b>RapidClip HA</b> for maximum spring tension of 30 kg</p>			
<p><b>RapidClip V</b> for maximum spring tension of more than 30 kg</p>			
<p><b>RapidClip FG R</b> for maximum spring tension of 45 kg e.g wood, metal and frame</p>			
<p><b>RapidClip FG</b> for maximum spring tension of 45 kg for wood and metal frames</p>			
<p><b>RapidClip FG</b> for maximum spring tension of 45 kg e.g wood, metal and frame</p>			

## BeA Bar Code Tools

Item No.	Description	Fastener type	Length from - to in mm	Capacity/ Pieces	Weight (net)
 12200030	Bar Code Tool K380/10-400	80/380	10	157	1.8 kg

Also available on request are plastic staples PB.

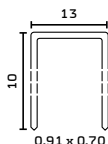

Item No.	Description	Mille/ Box	Mille/ Carton	Cartons/ Pallet	KG/ Carton
10000741	380/10 NK	1.8	144.0	48	19.0

## BeA Plastic Washer Stapler

Item No.	Description	Fastener type	Length from - to in mm	Capacity/ Pieces	Weight (net)
 12100425	Plastic Washer Stapler 340 C	G4450/25 + Plastic Washers	25	116 Staples + Plastic Washers	2.5 kg

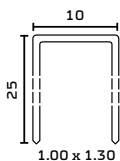

Item No.	Description	Mille/ Box	Mille/ Carton	Cartons/ Pallet	KG/ Carton
10900527	Plastic Washers (blue) and Staples G4450/25 NKH 2000 Plastic Washers and 2 Mille Staples	2.0	12.0	40	16.0

Available on request: plastic washers (white) with staples in 16 or 25 mm length

## BeA Glazier Tools

Item No.	Description	Fastener type	Length from - to in mm	Capacity/ Pieces	Weight (net)
 12100197	SK335-201 GL	SK 300	10 - 35	100	0.9 kg

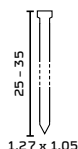

Item No.	Description	Mille/ Box	Mille/ Carton	Cartons/ Pallet	KG/ Carton
10300645	SK 325 NK	5	60.0	60	13.7
10300646	SK 330 NK	5	60.0	60	16.1
10300648	SK 335 NK	5	50.0	51	16.0

## BeA Deco Nailer

Item No.	Description	Fastener type	Length from - to in mm	Capacity/ Pieces	Weight (net)
 12100307	Deco Nailer ZN 100-410	ZN 100 Strips	-	60	1.1 kg

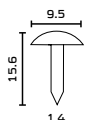

Item No.	Description	Mille/ Box	Mille/ Carton	Cartons/ Pallet	KG/ Carton
10700132	ZN 100 (Strips) Old Gold Spotted	3	18.0	35	14.3
10700134	ZN 100 (Strips) Bronze Renaissance	3	18.0	35	14.3







# BeA Screwdriver

for  
collated  
Screws

## BeA Industrial Screwdrivers

Item No.	Description	Fastener type	Length from - to in mm	Capacity/Pieces	Weight (net)
 12600038	SC 55/2500 FC 2500 RPM	SC	16 - 55	50	1.8 kg
 12600034	SC 55/4000 FC 4000 RPM	SC	16 - 55	50	1.8 kg
 12600039	SC 75/2500 WS 2500 RPM	SC	16 - 75	50	2.8 kg
 12600045	SC 75/2500 FT 2500 RPM	SC	16 - 75	50	1.8 kg

## BeA Cordless Screwdriver



for  
collated  
Screws

Item No.	Description	Fastener type	Length from - to in mm	Capacity/Pieces	Weight (net)
 12600156	SC 55/2 Speed 5000/1800 RPM with case	SC	25 - 55	50	2.3 kg
14509646	Battery 18V. 3.0AH LI-ION-T7				
14509663	Charger				
14513507	Bit 170 mm				



## BeA Pneumatic Screwdriver



Item No.	Description	Fastener type	Weight (net)
 12700063	Air Screwdriver US-LD 50P-05 500 U/m. 12.75 Nm	Screws for timber construction	0.9 kg
 12700064	Air Screwdriver US-LD 50P-08 900 U/m. 8.34 Nm	Screws for framing construction	0.9 kg

## BeA Bits and Colour Coding for BeFIX Screws

Item No.	Description	Bit. Length. mm	Bit. Colour Coding	Bits Piece/Box	Bits Piece/Carton
14509921	BIT 50 TX15	50	●	5	50
14509922	BIT 50 TX20	50	●	5	50
14509923	BIT 50 TX25	50	●	5	50
14509924	BIT 50 TX30	50	●	5	50
14509925	BIT 50 TX40	50	●	5	50
14513462	BIT 50 TX50	50	●	5	50
14509959	BIT 25 TX15	25	●	5	50
14509960	BIT 25 TX20	25	●	5	50
14509961	BIT 25 TX25	25	●	5	50
14509962	BIT 25 TX30	25	●	5	50
14509963	BIT 25 TX40	25	●	5	50
14513461	BIT 25 TX50	25	●	5	50
14509964	BIT Holder			1 piece	10 pieces
14509941	BIT BOX TX10-40*	25			



**\*Contents of the bit box: 31 TX bits and one magnetic bit holder**  
 5 x TX 10 white, 5 x TX 15 brown, 5 x TX 20 yellow, 5 x TX 25 blue, 5 x TX 30 red,  
 6 x TX 40 green, 1 magnetic bit holder





Item No.	Description	Mille/Box	Mille/Carton	Carton/Pallet	KG/Carton
<b>Drywall Screw, fine thread for 0.7mm metal studs</b>					
10600212	SC 3.5x25*	1.0	10.0	18	14.6
10600213	SC 3.5x30*	1.0	10.0	18	17.0
10600214	SC 3.5x35*	1.0	10.0	18	19.2
10600215	SC 3.5x40*	1.0	10.0	18	21.2
10600216	SC 3.5x45*	1.0	10.0	18	24.0
10600217	SC 3.5x55*	0.8	8.0	18	23.0



*Drywall Screw, bugle head, no. 2 Philips recess, fine thread, grey phosphated*

<b>Drywall Screw, coarse thread for wooden studs</b>					
10600221	SC 3.9x25*	1.0	10.0	18	14.6
10600222	SC 3.9x30*	1.0	10.0	18	17.0
10600273	SC 3.9x32*	1.0	10.0	18	18.0
10600223	SC 3.9x35*	1.0	10.0	18	19.0
10600224	SC 3.9x40*	1.0	10.0	18	21.2
10600225	SC 3.9x45*	1.0	10.0	18	24.0
10600226	SC 3.9x55	0.8	8.0	18	23.0
10600312	SC 4.5x75	1.0	6.0	18	29.7



*Drywall Screw, bugle head, no. 2 Philips recess, coarse thread, grey phosphated*

<b>Fibre cement board Screw, fine thread for 0.7mm metal studs</b>					
10600227	SC 3.9x22	1.0	10.0	18	12.0
10600228	SC 3.9x30	1.0	10.0	18	18.5
10600229	SC 3.9x35	1.0	10.0	18	21.5
10600230	SC 3.9x45	1.0	10.0	18	26.2



*Screw, small flat head with 4 ribs, no. 2 Philips recess, fine thread, grey phosphated*

<b>Fibre cement board Screw with Tek drilling point for 2 mm metal studs</b>					
10600291	SC 3.5x25	1.0	10.0	18	12.0



*Screw, small flat head with 4 ribs, no. 2 Philips recess, tek thread, drill point, grey phosphated*

<b>Drywall Screw with Tek drilling point, fine thread for 2mm metal studs</b>					
10600232	SC 3.5x35	1.0	10.0	18	19.5



*Self Drilling Screw, bugle head, no. 2 Philips recess, grey phosphated*

<b>Timber Screw, grey phosphated</b>					
10600234	SC 4.2x25	1.0	10.0	18	15.5
10600236	SC 4.2x35	1.0	10.0	18	21.0
10600238	SC 4.2x45	1.0	10.0	18	26.4
10600239	SC 4.2x55	1.0	8.0	18	25.4



*Timber Screw, small flat head with 4 ribs, no. 2 Philips recess, 2/3 hi-lo thread, diamond point, grey phosphated*

<b>Timber Screw, yellow phosphated</b>					
10600240	SC 4.2x30	1.0	10.0	18	18.3
10600241	SC 4.2x35	1.0	10.0	18	21.0
10600242	SC 4.2x40	1.0	10.0	18	22.9
10600243	SC 4.2x45	1.0	10.0	18	26.4
10600244	SC 4.2x55	1.0	8.0	18	25.4











*Timber Screw, small flat head with 4 ribs, no. 2 Philips recess, SS-2/3 hi-lo thread, diamond point, yellow zinc phosphated*

\* Conforms to DIN 18182 and EN 14566. BeA collated Screws fit in: Poppers, Prebena, Duraspin, Senco, Helfer, Fein, Hilti & Makita  
 \*\*Quality tested with 72 hr salt spray testing. Supplied in cartons only.





## BeA Drywall Screws, fine thread, loose



Item No.	Description	Pieces/ Box	Pieces/ Carton	KG/Carton
<b>Drywall Screws, fine thread</b>				
	11200146 SC 3.5x25 Gypsum Fine thread PH2 loose*	1,000	12,000	24.0
	11200147 SC 3.5x30 Gypsum Fine thread PH2 loose*	1,000	9,000	18.0
	11200148 SC 3.5x35 Gypsum Fine thread PH2 loose*	1,000	9,000	18.0
	11200149 SC 3.5x40 Gypsum Fine thread PH2 loose*	750	6,750	13.5
	11200150 SC 3.5x45 Gypsum Fine thread PH2 loose*	500	4,500	9.0
	11200151 SC 3.5x55 Gypsum Fine thread PH2 loose*	350	3,150	6.9
*Conforms to EN14566 and DIN 18182 Part 2				
<b>Fibre cement board Screw with Tek drilling point, fine thread</b>				
	11200152 SC 3.5x35 Gypsum Drilling point PH2 loose*	1,000	9,000	18.0
	11200153 SC 3.5x45 Gypsum Drilling point PH2 loose*	500	4,500	9.0
*Conforms to DIN 18182				
<b>Fibre cement board Screw, fine thread for 0.7 mm metal studs</b>				
	11200154 SC 3.9x22 FCB PH2 loose	1,000	12,000	24.0
	11200155 SC 3.9x30 FCB PH2 loose	1,000	9,000	18.0
	11200156 SC 3.9x45 FCB PH2 loose	500	4,500	5.0
<b>Fibre cement board Screw with Tek drilling point, fine thread for 2.0 mm metal studs</b>				
	11200157 SC 3.5x25 FCB Drilling point PH2 loose	1,000	12,000	24.0
				



## BeA Drywall Screws, coarse thread, loose



Item No.	Description	Pieces/ Box	Pieces/ Carton	KG/Carton
<b>Dry wall Screws, coarse thread, loose for wooden studs</b>				
	11200158 SC 3.9x25 Gypsum Coarse thread PH2 loose*	1,000	12,000	24.0
	11200159 SC 3.9x30 Gypsum Coarse thread PH2 loose*	1,000	9,000	18.0
	11200160 SC 3.9x32 Gypsum Coarse thread PH2 loose*	1,000	9,000	18.0
	11200161 SC 3.9x35 Gypsum Coarse thread PH2 loose*	1,000	9,000	18.0
	11200162 SC 3.9x40 Gypsum Coarse thread PH2 loose*	750	6,750	20.3
	11200163 SC 3.9x45 Gypsum Coarse thread PH2 loose*	500	4,500	13.5
	11200164 SC 3.9x55 Gypsum Coarse thread PH2 loose*	350	3,150	9.45
*Conforms to EN14566 and DIN 18182 Part 2				

## BeA Timber Screws, loose



Item No.	Description	Pieces/ Box	Pieces/ Carton	KG/Carton
<b>Timber Screw, grey phosphated</b>				
	11200165 SC 4.2x35 loose	1,000	9,000	27.0
	11200166 SC 4.2x40 loose	750	6,750	20.25
	11200167 SC 4.2x45 loose	500	4,500	13.5
	11200168 SC 4.2x55 loose	350	3,150	12.6





# BeA BeFIX Screws and BeA

# BeFix double threaded Screws for builders

Hardened "blue" zinc plated, chrome free VI, ETA approved

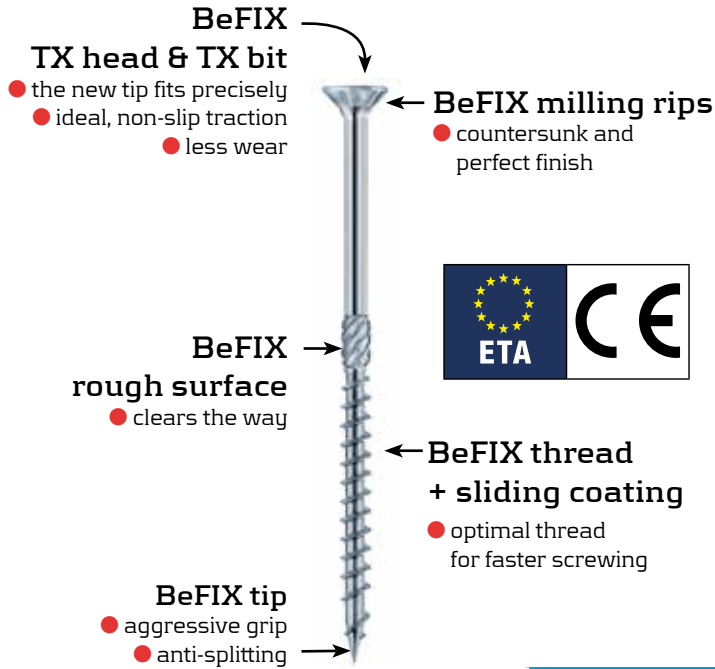

incl. 1 bit per box

BeFIX self drilling Screws are approved as construction products. The Screws are blue galvanized and chrome free VI. They are approved according to EN 1995-1-1 (Eurocode 5) class 1 and class 2 for interior use and covered spaces



## BeA Bits and Colour Coding for BeFIX Screws

Item No.	Description	Bit Length mm	Bit Colour Coding	Bits Piece/Box	Bits Piece/Carton
14509921	BIT 50 TX15	50	●	5	50
14509922	BIT 50 TX20	50	●	5	50
14509923	BIT 50 TX25	50	●	5	50
14509924	BIT 50 TX30	50	●	5	50
14509925	BIT 50 TX40	50	●	5	50
14513462	BIT 50 TX50	50	●	5	50
14509959	BIT 25 TX15	25	●	5	50
14509960	BIT 25 TX20	25	●	5	50
14509961	BIT 25 TX25	25	●	5	50
14509962	BIT 25 TX30	25	●	5	50
14509963	BIT 25 TX40	25	●	5	50
14513461	BIT 25 TX50	25	●	5	50
14509964	BIT Holder			1 piece	10 pieces
14509941	BIT BOX TX10-40*	25			

\*Contents of the bit box: 31 TX bits and one magnetic bit holder  
 5 x TX 10 white, 5 x TX 15 brown, 5 x TX 20 yellow, 5 x TX 25 blue, 5 x TX 30 red, 6 x TX 40 green, 1 magnetic bit holder



### BeFIX Screws are "blue" zinc coated

- chrome free VI
- higher corrosion resistance than ordinary coatings
- harder surface
- high resistance against wear and tear
- blue passivated and sealed surface
- approved to service class 1 and 2 according to EN 1995-1-1 (Eurocode 5)



### BeFIX Screws with aggressive grip tip

- faster screwing
- less screwing resistance
- ETA approval (European Technical Approval)

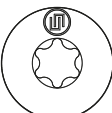

### BeFIX Screws with proven TX Bit

- the bit tip fits precisely into the Screw head
- the TX bit tip ensures an ideal, non slip traction

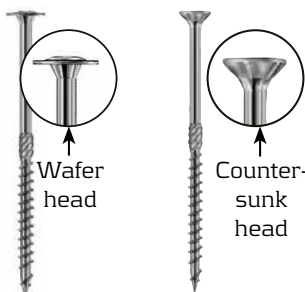

### Example of screw dimensions:

BeFIX TK 8.0x300/100/10

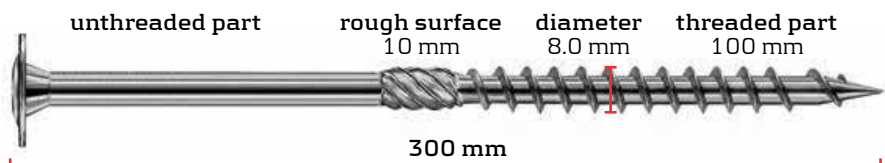



## BeFIX Wood Construction Screws with countersunk head



Ø 3.5 - 6.0 mm



Item No.	Description	Measurements in mm	Bit	Piece/Box	Piece/Carton	KG/Carton
11200087	BeFIX SK 3.5x35/21/4 TX15	3.5x35	TX 15 ●	1,000	12,000	18.0
11200004	BeFIX SK 3.5x40/24/4 TX15	3.5x40	TX 15 ●	1,000	9,000	15.7
11200005	BeFIX SK 3.5x45/27/4 TX15	3.5x45	TX 15 ●	500	6,000	11.4
11200006	BeFIX SK 3.5x50/30/4 TX15	3.5x50	TX 15 ●	500	6,000	12.3
11200007	BeFIX SK 4.0x30/18/5 TX20	4.0x30	TX 20 ●	1,000	12,000	21.5
11200008	BeFIX SK 4.0x40/24/5 TX20	4.0x40	TX 20 ●	1,000	9,000	20.8
11200009	BeFIX SK 4.0x45/27/5 TX20	4.0x45	TX 20 ●	500	6,000	15.1
11200010	BeFIX SK 4.0x50/30/5 TX20	4.0x50	TX 20 ●	500	6,000	16.8
11200011	BeFIX SK 4.0x60/36/5 TX20	4.0x60	TX 20 ●	200	3,600	11.8
11200012	BeFIX SK 4.0x70/42/5 TX20	4.0x70	TX 20 ●	200	3,600	13.7
11200013	BeFIX SK 4.5x40/24/7 TX25	4.5x40	TX 25 ●	500	9,000	28.8
11200014	BeFIX SK 4.5x50/30/7 TX25	4.5x50	TX 25 ●	500	6,000	21.8
11200015	BeFIX SK 4.5x60/36/7 TX25	4.5x60	TX 25 ●	200	2,400	10.4
11200016	BeFIX SK 4.5x70/42/7 TX25	4.5x70	TX 25 ●	200	2,400	12.2
11200017	BeFIX SK 4.5x80/48/7 TX25	4.5x80	TX 25 ●	200	2,400	13.6
11200018	BeFIX SK 5.0x40/24/8 TX25	5.0x40	TX 25 ●	200	3,600	13.3
11200019	BeFIX SK 5.0x50/30/8 TX25	5.0x50	TX 25 ●	200	3,600	17.4
11200020	BeFIX SK 5.0x60/36/8 TX25	5.0x60	TX 25 ●	200	2,400	12.8
11200021	BeFIX SK 5.0x70/42/8 TX25	5.0x70	TX 25 ●	200	2,400	15.8
11200022	BeFIX SK 5.0x80/48/8 TX25	5.0x80	TX 25 ●	200	2,400	16.7
11200023	BeFIX SK 5.0x90/54/8 TX25	5.0x90	TX 25 ●	200	2,400	19.6
11200024	BeFIX SK 5.0x100/60/8 TX25	5.0x100	TX 25 ●	200	2,400	20.9
11200025	BeFIX SK 5.0x120/70/8 TX25	5.0x120	TX 25 ●	200	2,400	24.4
11200026	BeFIX SK 6.0x60/36/10 TX30	6.0x60	TX 30 ●	200	2,400	19.7
11200027	BeFIX SK 6.0x70/42/10 TX30	6.0x70	TX 30 ●	200	2,400	21.0
11200028	BeFIX SK 6.0x80/48/10 TX30	6.0x80	TX 30 ●	200	2,400	23.8
11200029	BeFIX SK 6.0x90/54/10 TX30	6.0x90	TX 30 ●	100	1,800	19.7
11200030	BeFIX SK 6.0x100/60/10 TX30	6.0x100	TX 30 ●	100	1,200	14.5
11200031	BeFIX SK 6.0x110/70/10 TX30	6.0x110	TX 30 ●	100	1,200	16.4
11200032	BeFIX SK 6.0x120/70/10 TX30	6.0x120	TX 30 ●	100	1,200	18.0
11200033	BeFIX SK 6.0x130/70/10 TX30	6.0x130	TX 30 ●	100	1,200	18.9
11200034	BeFIX SK 6.0x140/70/10 TX30	6.0x140	TX 30 ●	100	1,200	19.9
11200035	BeFIX SK 6.0x150/70/10 TX30	6.0x150	TX 30 ●	100	1,200	21.4
11200036	BeFIX SK 6.0x160/70/10 TX30	6.0x160	TX 30 ●	100	1,200	22.8
11200037	BeFIX SK 6.0x180/70/10 TX30	6.0x180	TX 30 ●	100	900	19.0
11200038	BeFIX SK 6.0x200/70/10 TX30	6.0x200	TX 30 ●	100	900	21.0
11200039	BeFIX SK 6.0x220/70/10 TX30	6.0x220	TX 30 ●	100	900	25.7
11200040	BeFIX SK 6.0x240/70/10 TX30	6.0x240	TX 30 ●	100	600	16.7
11200088	BeFIX SK 6.0x260/70/10 TX30	6.0x260	TX 30 ●	100	600	17.9
11200041	BeFIX SK 6.0x280/70/10 TX30	6.0x280	TX 30 ●	100	600	19.5
11200042	BeFIX SK 6.0x300/70/10 TX30	6.0x300	TX 30 ●	100	600	21.2



## BeFIX Wood Construction Screws with countersunk head

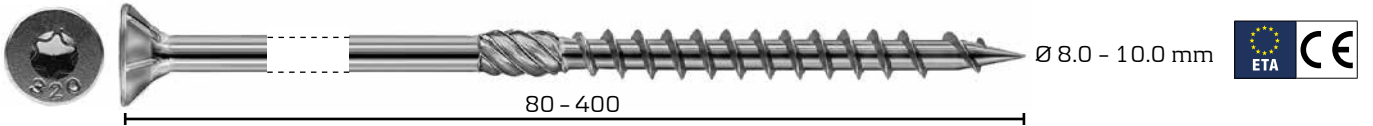

Item No.	Description	Measurements in mm	Bit	Piece/Box	Piece/ Carton	KG/ Carton
11200043	BeFIX SK 8.0x80/50/10 TX40	8.0x80	TX 40 ●	50	600	10.8
11200044	BeFIX SK 8.0x100/60/10 TX40	8.0x100	TX 40 ●	50	600	13.7
11200045	BeFIX SK 8.0x120/70/10 TX40	8.0x120	TX 40 ●	50	600	15.1
11200046	BeFIX SK 8.0x140/80/10 TX40	8.0x140	TX 40 ●	50	600	16.7
11200047	BeFIX SK 8.0x160/90/10 TX40	8.0x160	TX 40 ●	50	450	15.5
11200089	BeFIX SK 8.0x180/100/10 TX40	8.0x180	TX 40 ●	50	450	17.2
11200048	BeFIX SK 8.0x200/100/10 TX40	8.0x200	TX 40 ●	50	450	19.8
11200049	BeFIX SK 8.0x220/100/10 TX40	8.0x220	TX 40 ●	50	450	20.6
11200050	BeFIX SK 8.0x240/100/10 TX40	8.0x240	TX 40 ●	50	450	22.7
11200051	BeFIX SK 8.0x260/100/10 TX40	8.0x260	TX 40 ●	50	300	16.3
11200052	BeFIX SK 8.0x280/100/10 TX40	8.0x280	TX 40 ●	50	300	18.0
11200053	BeFIX SK 8.0x300/100/10 TX40	8.0x300	TX 40 ●	50	300	19.0
11200054	BeFIX SK 8.0x320/100/10 TX40	8.0x320	TX 40 ●	50	-	3.3
11200055	BeFIX SK 8.0x340/100/10 TX40	8.0x340	TX 40 ●	50	-	3.5
11200056	BeFIX SK 8.0x360/100/10 TX40	8.0x360	TX 40 ●	50	-	3.7
11200057	BeFIX SK 8.0x380/100/10 TX40	8.0x380	TX 40 ●	50	-	3.9
11200058	BeFIX SK 8.0x400/100/10 TX40	8.0x400	TX 40 ●	50	-	4.1
11200170	BeFIX SK 10.0x100/60/10 TX50	10.0x100	TX 50 ●	50	-	1.8
11200171	BeFIX SK 10.0x120/70/10 TX50	10.0x120	TX 50 ●	50	-	2.1
11200092	BeFIX SK 10.0x140/80/10 TX50	10.0x140	TX 50 ●	50	-	2.3
11200093	BeFIX SK 10.0x160/90/10 TX50	10.0x160	TX 50 ●	50	-	2.6
11200094	BeFIX SK 10.0x180/100/10 TX50	10.0x180	TX 50 ●	50	-	2.9
11200095	BeFIX SK 10.0x200/100/10 TX50	10.0x200	TX 50 ●	50	-	3.2
11200172	BeFIX SK 10.0x220/100/10 TX50	10.0x220	TX 50 ●	50	-	3.5
11200173	BeFIX SK 10.0x240/100/10 TX50	10.0x240	TX 50 ●	50	-	3.8
11200174	BeFIX SK 10.0x260/100/10 TX50	10.0x260	TX 50 ●	50	-	4.1
11200175	BeFIX SK 10.0x280/100/10 TX50	10.0x280	TX 50 ●	50	-	4.4
11200096	BeFIX SK 10.0x300/100/10 TX50	10.0x300	TX 50 ●	50	-	4.7
11200176	BeFIX SK 10.0x320/100/10 TX50	10.0x320	TX 50 ●	50	-	5.0
11200177	BeFIX SK 10.0x340/100/10 TX50	10.0x340	TX 50 ●	50	-	5.4
11200097	BeFIX SK 10.0x360/100/10 TX50	10.0x360	TX 50 ●	50	-	5.6
11200178	BeFIX SK 10.0x380/100/10 TX50	10.0x380	TX 50 ●	50	-	5.9
11200098	BeFIX SK 10.0x400/100/10 TX50	10.0x400	TX 50 ●	50	-	6.2





## BeFIX Wood Construction Screws with wafer head



loose  
Screws



Ø 6.0 - 10.0 mm



50 - 400

Item No.	Description	Measurements in mm	Bit	Piece/Box	Piece/Carton	KG/Carton
11200059	BeFIX TK 6.0x50/30/10 TX30	6.0x50	TX 30 ●	100	1,800	13.9
11200060	BeFIX TK 6.0x60/36/10 TX30	6.0x60	TX 30 ●	100	1,800	15.5
11200061	BeFIX TK 6.0x70/42/10 TX30	6.0x70	TX 30 ●	100	1,800	17.1
11200062	BeFIX TK 6.0x80/48/10 TX30	6.0x80	TX 30 ●	100	1,800	23.4
11200069	BeFIX TK 6.0x100/60/10 TX30	6.0x100	TX 30 ●	100	1,200	14.8
11200064	BeFIX TK 6.0x120/70/10 TX30	6.0x120	TX 30 ●	100	1,200	19.2
11200065	BeFIX TK 6.0x140/70/10 TX30	6.0x140	TX 30 ●	100	1,200	22.0
11200066	BeFIX TK 6.0x160/70/10 TX30	6.0x160	TX 30 ●	100	1,200	24.1
11200067	BeFIX TK 6.0x180/70/10 TX30	6.0x180	TX 30 ●	100	900	19.4
11200068	BeFIX TK 6.0x200/70/10 TX30	6.0x200	TX 30 ●	100	900	22.5
11200774	BeFIX TK 6.0x220/70/10 TX30	6.0x220	TX 30 ●	100	800	22.5
11200782	BeFIX TK 6.0x240/70/10 TX30	6.0x240	TX 30 ●	100	600	18.8
11200779	BeFIX TK 6.0x260/70/10 TX30	6.0x260	TX 30 ●	100	600	19.3
11200780	BeFIX TK 6.0x280/70/10 TX30	6.0x280	TX 30 ●	100	600	19.8
11200781	BeFIX TK 6.0x300/70/10 TX30	6.0x300	TX 30 ●	100	600	20.4
11200070	BeFIX TK 8.0x80/50/10 TX40	8.0x80	TX 40 ●	50	600	12.5
11200071	BeFIX TK 8.0x100/60/10 TX40	8.0x100	TX 40 ●	50	600	15.0
11200072	BeFIX TK 8.0x120/70/10 TX40	8.0x120	TX 40 ●	50	600	17.4
11200073	BeFIX TK 8.0x140/80/10 TX40	8.0x140	TX 40 ●	50	600	20.0
11200074	BeFIX TK 8.0x160/90/10 TX40	8.0x160	TX 40 ●	50	450	17.5
11200075	BeFIX TK 8.0x180/100/10 TX40	8.0x180	TX 40 ●	50	450	18.8
11200076	BeFIX TK 8.0x200/100/10 TX40	8.0x200	TX 40 ●	50	450	20.5
11200077	BeFIX TK 8.0x220/100/10 TX40	8.0x220	TX 40 ●	50	450	22.2
11200078	BeFIX TK 8.0x240/100/10 TX40	8.0x240	TX 40 ●	50	300	16.0
11200079	BeFIX TK 8.0x260/100/10 TX40	8.0x260	TX 40 ●	50	300	17.4
11200080	BeFIX TK 8.0x280/100/10 TX40	8.0x280	TX 40 ●	50	300	18.6
11200081	BeFIX TK 8.0x300/100/10 TX40	8.0x300	TX 40 ●	50	300	19.8
11200082	BeFIX TK 8.0x320/100/10 TX40	8.0x320	TX 40 ●	-	50	3.5
11200083	BeFIX TK 8.0x340/100/10 TX40	8.0x340	TX 40 ●	-	50	3.7
11200084	BeFIX TK 8.0x360/100/10 TX40	8.0x360	TX 40 ●	-	50	3.9
11200085	BeFIX TK 8.0x380/100/10 TX40	8.0x380	TX 40 ●	-	50	4.0
11200086	BeFIX TK 8.0x400/100/10 TX40	8.0x400	TX 40 ●	-	50	4.3
11200099	BeFIX TK 10.0x140/80/10 TX50	10.0x140	TX 50 ●	50	450	2.6
11200100	BeFIX TK 10.0x160/90/10 TX50	10.0x160	TX 50 ●	50	450	3.0
11200101	BeFIX TK 10.0x180/100/10 TX50	10.0x180	TX 50 ●	50	450	3.2



## BeFIX Wood Construction Screws with wafer head



Item No.	Description	Measurements in mm	Bit	Piece/Box	Piece/Carton	KG/Carton
11200102	BeFIX TK 10.0x200/100/10 TX50	10.0x200	TX 50 ●	50	300	3.5
11200103	BeFIX TK 10.0x220/100/10 TX50	10.0x220	TX 50 ●	50	300	3.7
11200104	BeFIX TK 10.0x240/100/10 TX50	10.0x240	TX 50 ●	-	50	4.1
11200105	BeFIX TK 10.0x260/100/10 TX50	10.0x260	TX 50 ●	-	50	4.4
11200106	BeFIX TK 10.0x280/100/10 TX50	10.0x280	TX 50 ●	-	50	4.7
11200107	BeFIX TK 10.0x300/100/10 TX50	10.0x300	TX 50 ●	-	50	4.9
11200108	BeFIX TK 10.0x320/100/10 TX50	10.0x320	TX 50 ●	-	50	5.3
11200109	BeFIX TK 10.0x340/100/10 TX50	10.0x340	TX 50 ●	-	50	5.6
11200179	BeFIX TK 10.0x360/100/10 TX50	10.0x360	TX 50 ●	-	50	6.0
11200180	BeFIX TK 10.0x380/100/10 TX50	10.0x380	TX 50 ●	-	50	6.3
11200110	BeFIX TK 10.0x400/100/10 TX50	10.0x400	TX 50 ●	-	50	6.6

## BeFIX Double Thread Screws for above rafter insulation



Item No.	Description	Measurements in mm	Bit	Piece/Box	Piece/Carton	KG/Carton
11200111	BeFIX TKD 8.0x165 TX40	8.0x165	TX 40 ●	50	450	17.3
11200112	BeFIX TKD 8.0x195 TX40	8.0x195	TX 40 ●	50	450	20.4
11200113	BeFIX TKD 8.0x225 TX40	8.0x225	TX 40 ●	50	450	22.8
11200114	BeFIX TKD 8.0x235 TX40	8.0x235	TX 40 ●	50	300	15.8
11200115	BeFIX TKD 8.0x255 TX40	8.0x255	TX 40 ●	50	300	17.5
11200116	BeFIX TKD 8.0x275 TX40	8.0x275	TX 40 ●	50	300	15.5
11200117	BeFIX TKD 8.0x302 TX40	8.0x302	TX 40 ●	50	-	4.3

## BeFIX Anchor Screw for timber connectors



Item No.	Description	Measurements in mm	Bit	Piece/Box	Piece/Carton	KG/Carton
11200001	BeFIX HVV 5.0x35 TX20	5.0x35	TX 20 ●	250	4,500	15.4
11200002	BeFIX HVV 5.0x40 TX20	5.0x40	TX 20 ●	250	4,500	16.8
11200003	BeFIX HVV 5.0x50 TX20	5.0x50	TX 20 ●	250	4,500	15.7

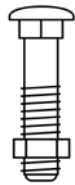

Item No.	Description		Piece/ Carton	Piece/ Pallet	KG/ Carton
<b>DIN603. 4.8 Cup head square neck bolt with nut, electro galvanized</b>					
11200639	FRS M 6x140	NK DIN 603	100	20,000	3.6
11200531	FRS M 8x30	NK DIN 603	200	19,200	4.6
11200532	FRS M 8x35	NK DIN 603	200	19,200	4.9
11200533	FRS M 8x40	NK DIN 603	200	19,200	5.4
11200564	FRS M 8x45	NK DIN 603	200	19,200	5.8
11200536	FRS M 8x50	NK DIN 603	200	19,200	6.0
11200413	FRS M 8x60	NK DIN 603	200	19,200	6.8
11200323	FRS M 8x70	NK DIN 603	100	22,000	3.8
11200508	FRS M 8x780	NK DIN 603	100	9,000	4.3
11200565	FRS M 8x790	NK DIN 603	100	9,000	4.8
11200324	FRS M 8x100	NK DIN 603	100	14,400	5.0
11200620	FRS M 8x110	NK DIN 603	100	14,400	5.2
11200566	FRS M 8x120	NK DIN 603	100	9,000	5.6
11200505	FRS M 8x140	NK DIN 603	50	5,000	3.0
11200325	FRS M10x80	NK DIN 603	100	14,400	6.8
11200326	FRS M10x100	NK DIN 603	100	11,000	8.1
11200510	FRS M10x120	NK DIN 603	50	10,000	5.2
11200486	FRS M10x140	NK DIN 603	50	10,000	7.7
11200484	FRS M10x130	NK DIN 603	50	10,000	5.0
11200534	FRS M12x50	NK DIN 603	100	5,500	5.2
11200567	FRS M12x60	NK DIN 603	100	5,500	6.2
11200568	FRS M12x70	NK DIN 603	100	5,500	7.2
11200327	FRS M12x80	NK DIN 603	50	7,200	5.2
11200328	FRS M12x110	NK DIN 603	50	5,500	6.5
11200329	FRS M12x120	NK DIN 603	50	5,500	7.0
11200330	FRS M12x130	NK DIN 603	50	5,500	7.4
11200202	FRS M12x140	NK DIN 603	50	5,500	7.1
11200203	FRS M12x150	NK DIN 603	50	5,500	7.5
11200204	FRS M12x160	NK DIN 603	25	5,000	3.9
11200205	FRS M12x180	NK DIN 603	25	4,500	4.3
11200206	FRS M12x190	NK DIN 603	25	4,200	4.4
11200207	FRS M12x200	NK DIN 603	25	4,350	4.6
11200209	FRS M12x220	NK DIN 603	25	3,750	5.0
11200210	FRS M12x240	NK DIN 603	25	3,500	5.3
11200211	FRS M12x250	NK DIN 603	25	3,500	5.5
11200212	FRS M12x260	NK DIN 603	25	3,350	5.7
11200214	FRS M12x270	NK DIN 603	25	3,300	5.8
11200215	FRS M12x280	NK DIN 603	25	3,000	6.0

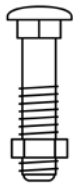
**BeA**  for Export and Professional Packaging

Item No.	Description		Piece/ Carton	Piece/ Pallet	KG/ Carton
<b>DIN603. 4.8 Cup head square neck bolt with nut, electro galvanized</b>					
11200216	FRS M12x290	NK DIN 603	25	3,000	6.2
11200217	FRS M12x300	NK DIN 603	25	3,000	6.3
11200611	FRS M12x320	NK DIN 603	25	3,000	6.7
11200219	FRS M12x340	NK DIN 603	25	2,500	7.0
11200220	FRS M12x360	NK DIN 603	25	2,400	7.4
11200221	FRS M12x380	NK DIN 603	25	2,400	7.7
11200480	FRS M12x 400	NK DIN 603	25	2,400	8.1
11200535	FRS M12x 420	NK DIN 603	25	2,400	8.5
11200481	FRS M12x 460	NK DIN 603	25	2,400	9.3
11200418	FRS M16x 140	NK DIN 603	25	2,500	7.5
11200506	FRS M16x 150	NK DIN 603	25	4,000	7.7
11200419	FRS M16x 160	NK DIN 603	25	2,500	7.9
11200222	FRS M16x180	NK DIN 603	25	2,500	8.1
11200223	FRS M16x200	NK DIN 603	25	2,400	8.8
11200224	FRS M16x220	NK DIN 603	25	2,200	9.4
11200225	FRS M16x240	NK DIN 603	25	2,000	10.0
11200226	FRS M16x260	NK DIN 603	25	2,000	10.6
11200227	FRS M16x280	NK DIN 603	25	1,800	11.3
11200228	FRS M16x300	NK DIN 603	25	1,800	11.9
11200229	FRS M16x320	NK DIN 603	25	1,700	12.5
11200230	FRS M16x340	NK DIN 603	25	1,600	13.1
11200231	FRS M16x360	NK DIN 603	25	1,500	13.8
11200232	FRS M16x380	NK DIN 603	25	1,400	14.4
11200233	FRS M16x400	NK DIN 603	25	1,350	15.0
11200234	FRS M16x420	NK DIN 603	15	1,300	9.4
11200235	FRS M16x440	NK DIN 603	15	1,250	9.8
11200236	FRS M16x460	NK DIN 603	15	1,200	10.1
11200237	FRS M16x480	NK DIN 603	15	1,200	10.5
11200238	FRS M16x500	NK DIN 603	15	1,200	10.9
11200239	FRS M16x520	NK DIN 603	15	1,005	11.3
11200240	FRS M16x580	NK DIN 603	15	1,005	12.4
11200241	FRS M16x620	NK DIN 603	15	900	13.1
11200604	FRS M20x280	NK DIN 603	15	900	15.0
11200242	FRS M20x360	NK DIN 603	15	1,000	17.0
11200243	FRS M20x380	NK DIN 603	15	1,000	17.8
11200244	FRS M20x400	NK DIN 603	20	920	18.6
11200245	FRS M20x420	NK DIN 603	20	900	19.5
11200246	FRS M20x440	NK DIN 603	20	800	20.3
11200247	FRS M20x460	NK DIN 603	20	800	21.1

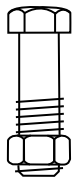

Item No.	Description	Piece/ Carton	Piece/ Pallet	KG/ Carton
<b>DIN601 Hexagon head bolt with nut, electro galvanized</b>				
11200540	SKSM M12x180 NK DIN 601	25	800	4.7
11200477	SKSM M12x500 NK DIN 601	25	800	12.5
11200498	SKSM M24x200 NK DIN 601	10	1,000	9.8



Item No.	Description	Piece/ Carton	Piece/ Pallet	KG/ Carton
<b>DIN976. 4.8 Thread rod, electro galvanized</b>				
11200400	GWS M10x1000 NK	25	2,000	12.3
11200248	GWS M12x480 NK	20	3,000	6.9
11200249	GWS M12x530 NK	20	2,500	7.6
11200250	GWS M12x1000 NK	20	1,500	14.3
11200251	GWS M12x1250 NK	20	1,000	17.9
11200252	GWS M16x1000 NK	10	800	13.1
11200253	GWS M16x1250 NK	10	600	16.4
11200254	GWS M16x1500 NK	10	500	19.7
11200255	GWS M16x2000 NK	10	400	26.2
11200256	GWS M20x1000 NK	10	500	20.5
11200258	GWS M20x1500 NK	10	300	30.8
11200475	GWS M20x2000 NK	10	300	35.0
11200261	GWS M24x1000 NK	5	350	14.2
11200383	GWS M24x2000 NK	5	350	28.4
11200259	GWS M30x1000 NK	5	200	23.4



Item No.	Description	Piece/ Carton	KG/ Carton
<b>Hexagon connecting sleeve, electro galvanized</b>			
11200394	VBM-SK M8x30 SW 13	100	2.4
11200395	VBM-SK M10x30 SW 17	50	2.1
11200334	VBM-SK M16x50 SW 24	25	3.1
11200335	VBM-SK M20x50 SW 30	25	4.8
11200336	VBM-SK M24x50 SW 36	25	6.9
11200337	VBM-SK M30x60 SW 46	25	13.5

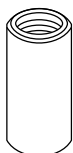

Item No.	Description	Piece/ Carton	KG/ Carton
<b>Round connecting sleeve, electro galvanized</b>			
11200338	VBM-RD M12x40 DRM 15 mm	100	2.4
11200339	VBM-RD M16x50 DRM 22 mm	25	1.9

BeA for Export and Professional Packaging



Item No.	Description	Pieces/Box	Piece/Carton	Piece/Pallet	KG/Carton
<b>DIN934-8 Hexagon nut, electro galvanized</b>					
11200396	SK Nut M 8 NK DIN 934	1,000	144,000	4.8	17.0
11200397	SK Nut M10 NK DIN 934	500	72,000	4.6	13.0
11200267	SK Nut M12 NK DIN 934	250	45,000	3.7	13.0
11200268	SK Nut M16 NK DIN 934	200	21,600	6.2	16.0
11200269	SK Nut M20 NK DIN 934	100	10,800	4.6	15.0
11200398	SK Nut M24 NK DIN 934	50	7,200	4.6	
11200399	SK Nut M30 NK DIN 934	25	2,700	6.2	



Item No.	Description	F1 max. in N	F2 max. in N	F3 max. in N	Pieces/Box	Piece/Carton	Piece/Pallet	KG/Carton
<b>DIN582 Eye nut, electro galvanized, C15E</b>								
11200408	RM M10 NK	2300	1700	1150	-	100	5,000	17,0
11200262	RM M12 NK	3400	2400	1700	5	50	4,800	13,0
11200263	RM M16 NK	7000	5000	3500	5	50	3,000	13,0
11200264	RM M20 NK	12000	8600	6000	5	40	2,000	16,0
11200265	RM M24 NK	18000	12900	9000	5	20	900	15,0



Item No.	Description	F1 max. in N	F2 max. in N	F3 max. in N	Pieces/Box	Piece/Carton	Piece/Pallet	KG/Carton
<b>DIN580 Lifting eye bolt, electro galvanized, C15E</b>								
11200569	RS M 8 NK	1400	1000	700	-	25	3,000	2,0
11200570	RS M10 NK	2300	1700	1150	-	25	3,000	3,2
11200438	RS M12 NK	3400	2400	1700	-	10	3,000	2,7
11200266	RS M16 NK	7000	5000	3500	5	50	3,000	15,0
11200571	RS M20 NK	12000	8600	6000	-	15	3,000	4,9

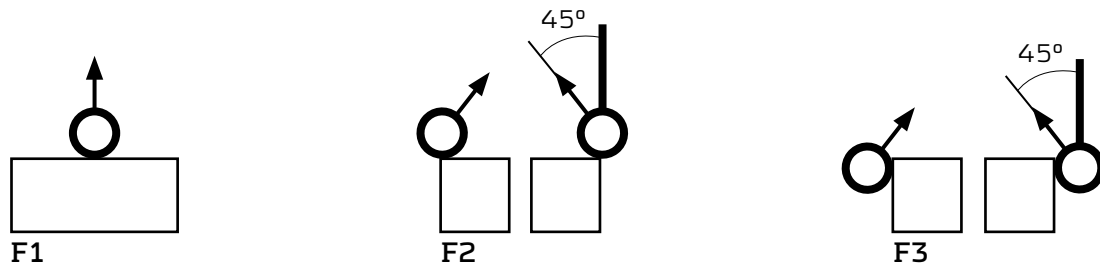



Item No.	Description	Piece/ Carton	Piece/ Pallet	KG/ Carton
<b>DIN436 Square washer with round hole, electro galvanized</b>				
11200309	SCH M12 40x40x13.5x4 NK DIN 436	100	14,000	4.6
11200310	SCH M16 50x50x17.5x5 NK DIN 436	100	8,600	8.9
11200311	SCH M20 60x60x22.0x5 NK DIN 436	50	4,300	6.3
11200390	SCH M24 80x80x26.0x6 NK DIN 436	25	2,150	6.9
11200391	SCH M30 95x95x33.0x6 NK DIN 436	25	2,150	9.6

Item No.	Description	Piece/ Carton	Piece/ Pallet	KG/ Carton
<b>DIN440R Washer with round hole, electro galvanized</b>				
11200387	SCH M6 22x6.6x2 NK DIN 440R	200	115,200	1.1
11200388	SCH M8 28x9.0x3 NK DIN 440R	200	54,400	2.6
11200389	SCH M10 34x11.0x3 NK DIN 440R	200	37,200	3.8
11200314	SCH M12 44x13.5x4 NK DIN 440R	200	17,200	8.7
11200315	SCH M16 56x17.5x5 NK DIN 440R	100	8,600	9.7
11200392	SCH M20 72x22.0x6 NK DIN 440R	50	4,300	8.7
11200393	SCH M24 85x26.0x6 NK DIN 440R	25	2,150	6.1

Item No.	Description	Piece/ Carton	Piece/ Pallet	KG/ Carton
<b>DIN440V Washer with square hole, electro galvanized</b>				
11200603	SCH M10 34x11.0x4 NK DIN 440R	250	100,000	4.9
11200320	SCH M12 44x14x14x4 NK DIN 440V	200	28,000	8.6
11200321	SCH M16 58x18x18x5 NK DIN 440V	100	8,600	8.7
11200322	SCH M20 68x22x22x5 NK DIN 440V	50	4,300	8.7

Item No.	Description	Piece/ Carton	Piece/ Pallet	KG/ Carton
<b>DIN9021 Washer with round hole, electro galvanized, HV 100</b>				
11200316	SCH M6 18x6.4x1.6 NK DIN 9021	200	115,200	0.6
11200384	SCH M8 24x8.4x2.0 NK DIN 9021	200	76,800	1.2
11200385	SCH M10 30x10.5x2.5 NK DIN 9021	200	54,400	2.4
11200317	SCH M12 37x13.0x3.0 NK DIN 9021	100	18,600	2.2
11200318	SCH M16 50x17.0x3.0 NK DIN 9021	100	14,000	4.1
11200319	SCH M20 60x22.0x4.0 NK DIN 9021	100	8,600	7.7

**BeA**  for Export and Professional Packaging

Item No.	Description		Piece/ Carton	Piece/ Pallet	KG/ Carton
<b>DIN571 Hexagon head wood Screw, electro galvanized</b>					
11200274	SK-HS 6x80 NK DIN 571		200	57,600	2.9
11200275	SK-HS 8x50 NK DIN 571		200	36,000	3.6
11200276	SK-HS 8x60 NK DIN 571		200	28,800	4.2
11200631	SK-HS 8x80 NK DIN 571		100	21,600	3.0
11200278	SK-HS 8x100 NK DIN 571		100	21,600	3.2
11200279	SK-HS 8x160 NK DIN 571		50	14,400	2.5
11200286	SK-HS 10x60 NK DIN 571		100	18,000	3.7
11200288	SK-HS 10x80 NK DIN 571		100	14,400	4.5
11200289	SK-HS 10x100 NK DIN 571		100	10,800	5.4
11200290	SK-HS 10x120 NK DIN 571		50	10,800	3.1
11200291	SK-HS 10x140 NK DIN 571		50	9,000	3.6
11200292	SK-HS 10x150 NK DIN 571		50	9,000	3.7
11200293	SK-HS 10x160 NK DIN 571		25	7,200	2.0
11200294	SK-HS 10x180 NK DIN 571		25	7,200	2.2
11200471	SK-HS 10x200 NK DIN 571		50	5,500	5.1
11200512	SK-HS 10x220 NK DIN 571		50	7,200	6.5
11200513	SK-HS 10x240 NK DIN 571		50	7,200	7.9
11200298	SK-HS 12x100 NK DIN 571		50	9,000	3.2
11200299	SK-HS 12x120 NK DIN 571		50	7,200	4.5
11200300	SK-HS 12x140 NK DIN 571		50	5,400	5.1
11200301	SK-HS 12x160 NK DIN 571		25	5,400	3.1
11200302	SK-HS 12x180 NK DIN 571		25	4,500	3.4
11200303	SK-HS 16x120 NK DIN 571		25	3,600	4.1

For information  
[www.bea-group.com](http://www.bea-group.com)  
 or call +49 (0)4102 78-445

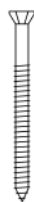

Item No.	Description	Piece/ Carton	Piece/ Pallet	KG/ Carton
<b>Chipboard Screw, TX head, electro galvanized</b>				
11200700	SPS 3.0x16 NK TX 10	1000	1,080,000	0.6
11200341	SPS 3.0x20 NK TX 10	1000	1,080,000	0.7
11200342	SPS 3.0x25 NK TX 10	1000	540,000	0.9
11200736	SPS 3.0x30 NK TX 10	1000	360,000	1.0
11200344	SPS 3.5x16 NK TX 15	1000	540,000	0.8
11200345	SPS 3.5x25 NK TX 15	1000	360,000	1.1
11200748	SPS 3.5x30 NK TX 15	1000	360,000	1.3
11200761	SPS 3.5x35 NK TX 15	1000	270,000	1.6
11200765	SPS 3.5x50 NK TX 15	500	180,000	1.1
11200701	SPS 4.0x16 NK TX 20	1000	540,000	1.1
11200702	SPS 4.0x20 NK TX 20	1000	360,000	1.3
11200703	SPS 4.0x25 NK TX 20	1000	360,000	1.6
11200737	SPS 4.0x30 NK TX 20	1000	360,000	1.8
11200353	SPS 4.0x35 NK TX 20	1000	270,000	2.1
11200704	SPS 4.0x40 NK TX 20	1000	180,000	2.3
11200355	SPS 4.0x45 NK TX 20	500	135,000	1.2
11200705	SPS 4.0x50 NK TX 20	500	135,000	1.3
11200749	SPS 4.0x60 NK TX 20	500	135,000	1.6
11200706	SPS 4.0x70 NK TX 20	200	72,000	0.7
11200581	SPS 5.0x20 NK TX 20	1000	180,000	3.3
11200466	SPS 5.0x30 NK TX 25	500	180,000	1.8
11200745	SPS 5.0x35 NK TX 25	500	180,000	1.6
11200359	SPS 5.0x40 NK TX 25	500	135,000	1.8
11200709	SPS 5.0x50 NK TX 25	500	135,000	2.2
11200444	SPS 5.0x55 NK TX 25	500	90,000	2.3
11200361	SPS 5.0x60 NK TX 25	200	54,000	1.0
11200750	SPS 5.0x70 NK TX 25	200	54,000	1.2
11200738	SPS 5.0x80 NK TX 25	200	54,000	1.3
11200739	SPS 5.0x90 NK TX 25	200	54,000	1.5
11200751	SPS 5.0x100 NK TX 25	200	54,000	1.6
11200762	SPS 5.0x120 NK TX 25	100	54,000	1.0
11200367	SPS 6.0x30 NK TX 30	500	180,000	2.2
11200368	SPS 6.0x40 NK TX 30	200	90,000	1.1
11200369	SPS 6.0x50 NK TX 30	200	72,000	1.3
11200766	SPS 6.0x60 NK TX 30	200	54,000	1.5
11200741	SPS 6.0x70 NK TX 30	200	54,000	1.7
11200742	SPS 6.0x80 NK TX 30	200	54,000	2.0
11200373	SPS 6.0x90 NK TX 30	100	54,000	1.1
11200743	SPS 6.0x100 NK TX 30	200	30,000	2.5
11200375	SPS 6.0x120 NK TX 30	100	27,000	1.4
11200740	SPS 6.0x140 NK TX 30	100	27,000	1.6
11200744	SPS 6.0x160 NK TX 30	100	27,000	1.9
11200710	SPS 6.0x180 NK TX 30	100	18,000	2.1
11200379	SPS 6.0x200 NK TX 30	100	18,000	2.3

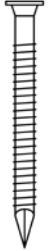
**BeA**  for Export and Professional Packaging

Item No.	Description	Pieces/ Box	Piece/ Carton	Piece/ Pallet	KG/ Carton
<b>Anchor nail, loose, electro galvanized</b>					
20100181	6.0x80	250	1000	40,000	17.8
20100193	6.0x100	250	1000	40,000	22.3



Item No.	Description	KG/ Carton	Carton/ Pallet	KG/ Pallet
<b>Wire nail, loose, bright steel</b>				
15200472	2.5x50	2.5	400	1.000
15200474	2.5x56	2.5	400	1.000
15200168	3.1x80	5.0	200	1.000
15201198	4.0x100	5.0	200	1.000
15201199	4.5x130	5.0	200	1.000
15201200	5.6x160	5.0	200	1.000
15201201	6.3x180	5.0	200	1.000
15201202	7.1x210	5.0	200	1.000







## BeA Timber Connectors

	Description	Dimensions / Materials / Applications
	<p>Joist Hangers Legs inside and outside</p>	<ul style="list-style-type: none"> <li>- Available in different sizes</li> <li>- Galvanized steel plates</li> <li>- For fixing beams</li> </ul>
	<p>Angle Brackets</p>	<ul style="list-style-type: none"> <li>- Available in different sizes</li> <li>- Galvanized steel plates</li> <li>- For fixing trimmed joist to timber</li> </ul>
	<p>Roof Ridge Fixing</p>	<ul style="list-style-type: none"> <li>- Available in lengths 160 - 370 mm</li> <li>- Galvanized steel plates</li> <li>- Used in roof frames and for cross beams</li> </ul>
	<p>Perforated Plates</p>	<ul style="list-style-type: none"> <li>- Available in different sizes</li> <li>- Galvanized steel plates</li> <li>- Used mainly in beam and roof constructions</li> </ul>
	<p>Truss Brace</p>	<ul style="list-style-type: none"> <li>- Available in different sizes</li> <li>- Galvanized steel plates</li> <li>- Used for stabilizing timber constructions</li> </ul>
	<p>True Shoe Wood and Concrete</p>	<ul style="list-style-type: none"> <li>- Available in type H for wood and type B for concrete</li> <li>- Hot dipped galvanized steel plates</li> </ul>
	<p>Bulk Nails</p>	<ul style="list-style-type: none"> <li>- Available in lengths 80 - 330 mm</li> <li>- For roof trusses</li> </ul>
	<p>HVV Anchor Nails</p>	<ul style="list-style-type: none"> <li>- Available in lengths 35 - 100 mm. Ø 4.0 mm</li> <li>- For fastening HVV timber connectors</li> </ul>



## BeA Timber Connectors

	Description	Dimensions / Materials / Applications
	Gusset Plates	<ul style="list-style-type: none"> <li>- Available in lengths 90, 130, 170 and 210 mm</li> <li>- Galvanized steel plates</li> <li>- Used for anchoring timber when fixing roofing sheets</li> </ul>
	Angled Lugs	<ul style="list-style-type: none"> <li>- Available in different sizes</li> <li>- Steel plate. Hot galvanised after punching</li> <li>- Used for fixing wood to concrete</li> </ul>
	T Anchor Plates	<ul style="list-style-type: none"> <li>- Available in lengths 160, 180 and 200 mm</li> <li>- Galvanized steel plates</li> <li>- For simple fixing of a T girder to timber</li> </ul>
	Column Shoes	<ul style="list-style-type: none"> <li>- Available in different types and sizes</li> <li>- Hot dipped galvanized after welding</li> <li>- Used for casting in concrete when fixing posts</li> </ul>



BeA supplies a wide variety of timber connectors. Contact us for further information and special offers available.

## BeA Hotmelt Technology

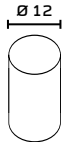

	Item No.	Description	Fastener type	Capacity/ Pieces	Weight (net)
	12500191	BeA 295 Adjustable temperature from 130° - 200°C	Sticks Ø 12 mm	1 Stick	0.6 kg



Item No.	Description	Carton/ Pallet	KG/ Carton
11800220	HM 505/12	36	10.0
11800221	HM 535/12	35	10.0
11800222	HM 665/12	35	10.0



## BeA Hotmelt Technology

	Item No.	Description	Fastener type	Capacity/ Pieces	Weight (net)
	12500186	BeA 315 With digital temperature control	Sticks Ø 43 mm	2 Sticks	1.2 kg
	12500077	BeA 321 Glue is dispensed by a pneumatic piston	Sticks Ø 43 mm	2 Sticks	1.5 kg
	12500078	BeA 351 For spray application	Sticks Ø 43 mm	2 Sticks	1.4 kg
	14000159	Pressure regulator			

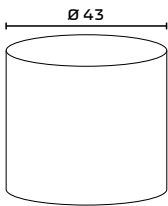

Item No.	Description	Carton/ Pallet	KG/ Carton
11800074	HM 502/43	36	10.0
11800075	HM 532/43	36	10.0
11800077	HM 640/43	36	10.0
11800078	HM 642/43	36	10.0
11800080	HM 660/43	36	10.0
11800070	SP 420/43	100	36.0
11800072	SP 431/43	100	36.0
11800261	SP 435/43 for concrete applications	100	36.0



## HOTMELT STICKS - Ø 12 mm and 43 mm

Hotmelt, Basis E Ethylenvinylacetat (EVA)	Available in Ø mm	Colour	Open Time * <sup>1</sup>	Softening Point * <sup>2</sup>	Heat Resistance * <sup>3</sup>	Low Temperature Flexibility * <sup>4</sup>
HM 501	12 & 43	Pale amber	15 sec	106° C	65° C	
HM 502	43	Light brown	10 sec	100° C	85° C	
HM 505	12	Clear transparent	10 sec	105° C * <sup>6</sup>	60° C * <sup>7</sup>	X
HM 532	43	Clear transparent	15 sec	86° C	75° C	X
HM 535	12	Clear transparent	25 sec	95° C * <sup>6</sup>	60° C * <sup>7</sup>	X
HM 542	43	Ivory	5 sec	104° C	75° C	
HM 640	12 & 43	Clear transparent	45 sec	84° C	75° C	X
HM 642	12	Brown	40 sec	90° C	80° C	
HM 642	43	Brown	40 sec	90° C	70° C	
HM 660	12	Pale amber	40 sec	87° C	70° C	
HM 660	43	Pale amber	30 sec	85° C	70° C	X
HM 665	12	Yellow	35 sec	88° C * <sup>6</sup>	55° C * <sup>7</sup>	
Spray Hotmelt Basis Polyolefin	Available in Ø mm	Colour	Open Time * <sup>1</sup>	Softening Point * <sup>2</sup>	Heat Resistance * <sup>3</sup>	Low Temperature Flexibility * <sup>4</sup>
SP 410	43	Pale amber	1 min	125° C	80° C	X
SP 420	43	Pale amber	3 min	105° C	85° C	
SP 431	43	Pale amber	6 min	105° C	80° C	
SP 435	43	Pale amber	3 min	105° C	80° C	

\*<sup>1</sup>) BS5350 H4

\*<sup>2</sup>) ASTM E28

\*<sup>3</sup>) BS 5350 H3

\*<sup>4</sup>) Flexible up to -20 °C

\*<sup>5</sup>) ASTM D3236

Further hotmelts are available on request. Customers own tests are recommended.

Viscosity 180° cps <sup>*5</sup>	Characteristics	Typical Applications
2.000	Relative short open time, good adhesion to many surfaces	Porous materials e.g. paper, wood, textile, foams, packaging
4.500	Short open time, very high molten tack	Packaging
5000 <sup>*8</sup>	Short open time, very high molten tack	Packaging
9.500	Transparent, good adhesion to many surfaces, high viscosity and excellent gap filling, middle open time	General purpose adhesive (paper, wood, textile, foam)
20000 <sup>*8</sup>	Transparent, good adhesion to many surfaces, high viscosity and excellent gap filling, middle open time	General purpose adhesive (paper, wood, textile, foam)
9.500	Very short open time	Packaging
5.500	Transparent, long open time, good adhesion to many surfaces	General purpose adhesive (textile, wood, plastics), excellent performance
5.500	Transparent, long open time, good adhesion to many surfaces	General purpose adhesive (textile, wood, plastics e.g: polyamide, polystrol etc.)
3.500	Transparent, long open time, good adhesion to many surfaces	General purpose adhesive (textile, wood, plastics e.g: polyamide, polystrol etc.)
6.800	Forms a tough but flexible bond, long open time, for general materials	General materials (metal, glass, plastics, ceramics, fibreglass, paper and board)
1.950	Forms a tough but flexible bond, long open time, for general materials	General materials (metal, glass, plastics, ceramics, fibreglass, paper and board)
5.000 <sup>*8</sup>	Forms a tough but flexible bond, long open time, for general materials	General materials (metal, glass, plastics, ceramics, fibreglass, paper and board)

Viscosity 180° cps <sup>*5</sup>	Characteristics	Typical Applications
3.200	Suitable for spraying and bead applications, excellent low temperature flexibility	Pallet stabilising, packaging
4.500	Formulated for spraying, long open time, good adhesion to many surfaces	Packaging foams, formed mouldings, upholstery foams, most plastics
4.000	Formulated for spraying, very long open time, good adhesion to many surfaces, tough shock resistant bond	Most plastics, foams, wood and cardboard
2.500	Formulated for spraying, very long open time, good adhesion to many surfaces, tough shock resistant bond	Wood, plastic and metal. specially developed for the concrete industry

\*6) following DIN52011

\*7) WPS 68

\*8) following DIN53211



## BeA Compressors

Description	Item No.		Weight (net)			
 Compressor K 160-6	12400086		9 kg			
	Volume/ min	Output volume	Max. pressure	Capacity	Voltage	Engine power
	160 l/min	65 l/min	8 bar	6 litre	220 V	1.1 kW

Description	Item No.		Weight (net)			
 Compressor K 194-10	12400163		25 kg			
	Volume/ min	Output volume	Max. pressure	Capacity	Voltage	Engine power
	190 l/min	100 l/min	8 bar	10 litre	230 V	1.6 kW

Description	Item No.		Weight (net)			
 Compressor K 270 - 20 oil free	12400123		45 kg			
	Volume/ min	Output volume	Max. pressure	Capacity	Voltage	Engine power
	265 l/min	160 l/min	10 bar	20 litre	220 V	1.8 kW

Description	Item No.		Weight (net)			
 Compressor KV 350-15	12400093		50 kg			
	Volume/ min	Output volume	Max. pressure	Capacity	Voltage	Engine power
	350 l/min	240 l/min	10 bar	15 litre	220 V	2.2 kW

Description	Item No.	Weight (net)
 Hose drum 30 m inner diameter 8.5 mm	14000406	9 kg

## BeA Power Packages

BeA Power Package (K160 Kit) comprising:



Compressor K160-6

+



Spiral Hose

+



Blow Gun

+



Stapler of your choice (see below)

Item No.	Description	Weight
12100493	KIT K160 with 380/16-420 (tool description page 29)	14 kg
12100495	KIT K160 with 380/16-429LN (tool description page 29)	14 kg
12100499	KIT K160 with SKAM 350-226C (tool description page 54)	14 kg
12100500	KIT K160 with SKS 650-228 (tool description page 56)	14 kg





# BeA Autotec



BeA Autotec

Made in Germany

**BeA robot  
reloading system**  
Magazine capacity up to  
30,000 fasteners in lengths  
ranging from 6 - 65mm

For specific fastener  
information, please  
contact us

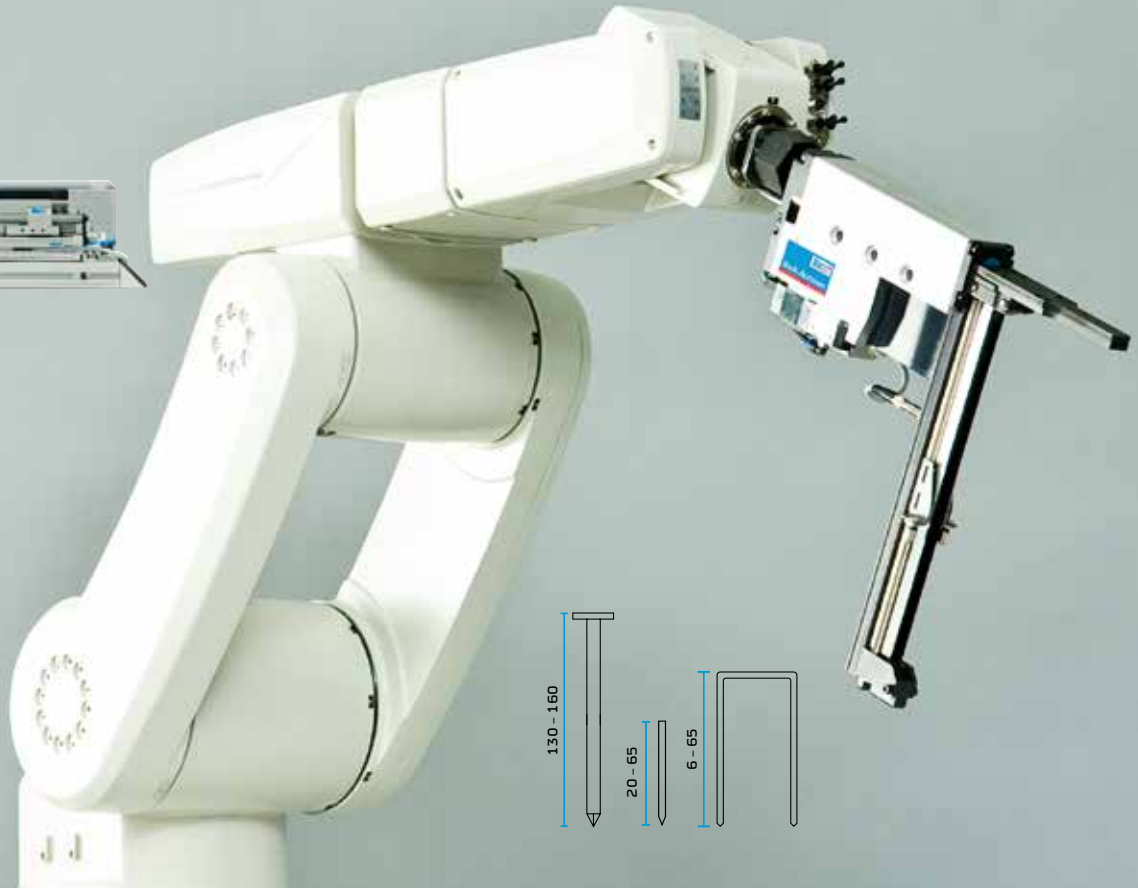

# BeA Automated Fastening Systems – reaching beyond standard solutions

## BeA robot nailer with reloading station

For staples and pins

Incorporates fully automated production processes by being mounted on either multi axis robots or X/Y/Z linear units.

- Small dimensions and low weight accommodate easy handling and high process speeds. The automatic reloading feature minimizes the tools weight by carrying only the necessary amount of fasteners per cycle
- Placement and stapling possible in any position and orientation
- Very high capacity of the stationary reloading unit (up to 30,000)

### Applications:

*Furniture industry, automotive, moulds for sand casting and specialty crate manufacturing*



## BeA Automated Fastening Systems – Highlights

- 2020 New BeA Autotec 244 with change over cassette and BeA Autotec 288 for jumbo coils up to 2500 nails
- 2019 First BeA Autotec Screwdriver
- 2015 First automatic reloading station for 20 degree Strip Nails used in a robotic Autotec Strip Nailer solution
- 2014 First BeA Autotec tool for Staples with a diameter of 3.0 mm
- 2003 First BeA Autotec tool for wide crown Staples
- 1999 First BeA Autotec tool with change over cassette
- 1989 First BeA Autotec tool

BeA Autotec offers a large programme of products, systems and solutions, tailor-made individually according to your needs and production type. Outstanding application for prefabricated house furniture, automobile and electrical industries, packaging, wood to wood components and many more.

### BeA Autotec Screwdriver

For coil screw length 35 – 80 mm, Ø 4 – 5 mm

- Preset penetration depth +/- 2 mm, adjustable in 0.25 mm steps
- Optimal screwing performance
- Noise reduction
- Jumbo coil magazine
- Optimal screw alignment through screw guide

**Applications:** All applications which require flush setting of the screws, e.g. planking of stud frames with Fermacell, chipboards, etc. in the prefabricated house industry (also available with 1500 rpm for steel applications)

Description	Autotec Screwdriver
Magazine and Capacity	Coil magazine, capacity 700 Screws
Actuation mode	Electronically via signal
Fastener type	Screws
Length	35 – 80 mm (with conversion kit)
Diameter	4 – 5 mm (with conversion kit)
Working pressure	6 – 8 bar
Motor power	1.5 kW
Rotational speed	3000 rpm (wood)/1500 rpm(steel)
Power supply	400 V three phase alternating current
Torque	5 Nm
Screws per second	1
Distance to panel while moving	25 mm
To be used in automated production lines with suitable equipment	



**Jumbo coil:**  
Magazine capacity  
700 Screws





**BeA Autotec tool 264 / 284 with change over cassette**

Magazine capacity: up to 2,300 staples  
Leg lengths: 25 - 80 mm

- Compact design
- High speed reloading
- Low maintenance
- Long operating life
- Frequency up to 10 staples per second
- Electronic placement and magazine control

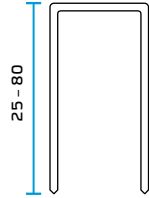

**Applications:** Specifically designed for plant manufacturing

**BeA Autotec tool 244 with change over cassette**

Magazine capacity: up to 3,000 staples  
Leg lengths: 21- 32 mm

- Frequency up to 8 staples per second
- Compact design
- High speed reloading
- Electronic placement and magazine control

**Applications:** Layering of drywall.  
Specifically designed for plant manufacturing.

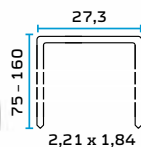
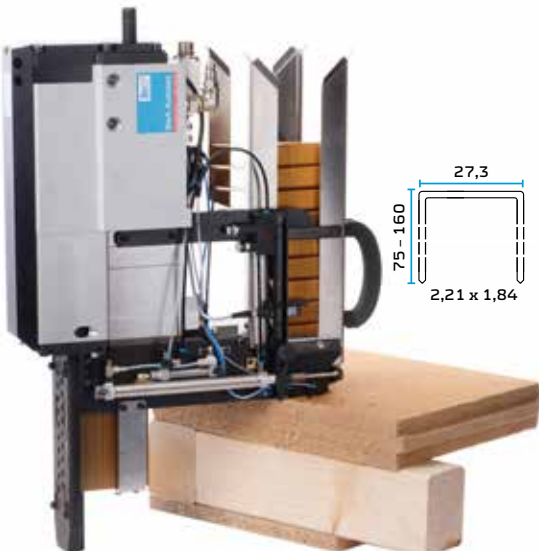
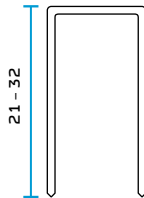

**BeA Autotec 246/284 SL**

For 246 Staples, L: 75 - 160 mm, Crown-Width: 27.3 mm

- Insulation and ETICS installation
- Fasten boards up to 130 mm
- Enhanced productivity and quality
- Up to 2 staples per second
- Minimized change over and reload times with high capacity cassette magazine

**Applications:** Insulation fixing in timber frame fabrication wood fibre and polystyrol boards < 130 mm

**STAPLES 246**

Length	Magazine type	Frequency/Sec
75 - 160 mm	Cassette	max 2 /sec





**BeA Autotec 346/284 SL for insulation fixing in automated panel and element production**

- Insulation and ETICS installation
- Fasten boards up to 160 mm
- Enhanced productivity and quality
- Up to 2 staples per second
- Minimized change over and reload times with high capacity cassette magazine

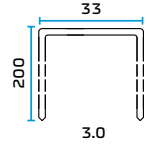

**Applications:** Insulation fixing in timber frame fabrication wood fibre <160 mm

**STAPLES 346**

Length	Magazine type	Frequency/Sec
200 mm	Cassette	max 2/sec

**BeA Autotec tool for jumbo coils**

Magazine capacity: up to 900 nails  
Plastic and wire collated  
Nail lengths: 45 - 90 mm

- High magazine capacity
- Electronic placement and magazine control
- Accurate nail placement
- Low maintenance
- Long operating life
- Frequency up to 4 nails per second

**Applications:** Prefabricated houses, furniture frames, pallets and crates

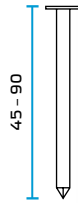

**BDC NAILS**

Nails	Magazine capacity	Frequency/sec.	Air consumption
Ø 2.5 - 3.4 / 45 - 90 mm	1 jumbo coil / 750 - 900 Nails	max 4/sec	2.5 - 4 litres at 6 bar

**TC NAILS**

Nails	Magazine capacity	Frequency/sec.	Air consumption
Ø 2.5 - 3.1 / 45 - 90 mm	1 jumbo coil / 750 - 900 Nails	max 4/sec	2.5 - 4 litres at 6 bar



**BeA Autotec tool 288 for jumbo coils up to 2500 nails**

Magazine capacity: up to 2500 nails  
Wire collated  
Nail lengths: 50 - 80 mm

- High magazine capacity
- Electronic placement and magazine control
- Accurate nail placement
- Low maintenance
- Long operating life
- Frequency up to 4 nails per second

**Applications:** Prefabricated houses, furniture frames, pallets and crates

**BDC NAILS**

Nails	Magazine capacity	Frequency/sec.	Air consumption
Ø 2.5 - 3.1 / 50 - 80 mm	1 jumbo coil / up to 2500 Nails	max 4/sec	2.5 - 4 litres at 6 bar



**BeA Autotec Pusher for Nail type W12 and K-Coil**  
 Ø 2.1 - 2.8, L: 35 - 50 mm, Head-Ø: max 6.2 mm

- Elevation adjustment up to 30 mm
- Adjustable penetration depth +/- 2 mm
- Optimal nailing performance
- Fast pushing technology >2 Nails/sec
- Noise reduction
- Jumbo coil magazine
- Nail guide ensures 90° nail position while pushing

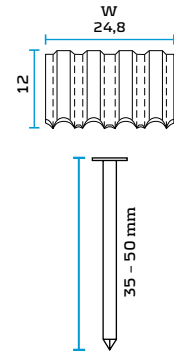

**Applications:** Applications where flush nail drives are needed: fire protection boards, plaster, gypsum boards and facades

Nails	Magazine capacity	Frequency	Compression force
Ø 2.1 - 2.8 mm	1 Jumbo Coil	max 2 /sec	350 - 500 kg

**BeA Autotec tool Strip Nailer**

Magazine capacity: up to 160 nails, leg lengths: 50 - 100 mm

- Adjustable magazine capacity
- Electronic placement and magazine control
- Low maintenance
- Long operating life

**Applications:** Prefabricated houses, furniture frames, pallets and crates

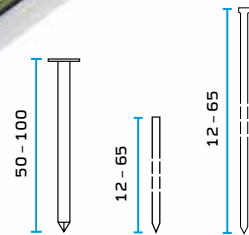

**ROUND HEAD NAILS**

Nails	Magazine capacity	Frequency/sec.	Air consumption
Ø 2.8 - 4.1 / 50 - 100 mm	120 Nails	max 4 - 5 /sec	3.5 - 4 litres at 6 bar

**D HEAD NAILS**

Nails	Magazine capacity	Frequency/sec.	Air consumption
Ø 2.9 - 3.4 / 50 - 100 mm	160 Nails	max 4 - 5 /sec	3.5 - 4 litres at 6 bar

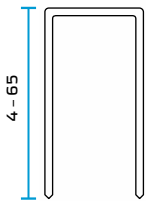
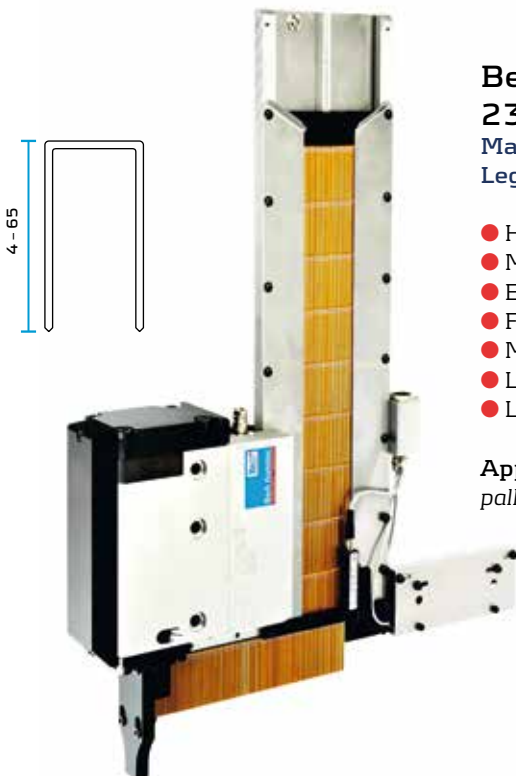

**BeA Autotec tool top loader 230 / 240 / 260 / 280**

Magazine capacity: up to 10,000 staples  
 Leg lengths: 4 - 65 mm

- High magazine capacity
- Minimal reloading time
- Electronic placement and magazine control
- Frequency up to 8 staples per second
- Multiple mounting options facilitate installation
- Low maintenance
- Long operating life

**Applications:** Prefabricated houses, furniture, packaging, pallets and crates



**BeA Autotec tool side loader  
232 / 242 / 262 / 282**

Magazine capacity: up to 5,000 staples  
Leg lengths: 4 - 110 mm

- High magazine capacity
- Automatic reloading - avoid time consuming manual reloading
- Electronic placement and magazine control
- Frequency up to 8 cycles per second
- Multiple mounting options facilitate installation

**Applications:** Prefabricated houses, furniture, packaging, pallets and crates

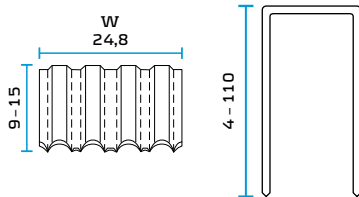

**The BeA Autotec system offers the following benefits:**

- Precision German manufactured equipment that guarantees performance reliability
- Automated staple signal input, either 24V DC or pneumatic
- Individual energy adjustment of the stapler head to the specific application
- Wide array of accessories, including electronic placement and magazine control, edge guides and rollers etc.
- Reduces your manufacturing costs through
  - Customized design
  - Installation into new or existing equipment
  - Availability of customized components and accessories for tool mounting and fastener application

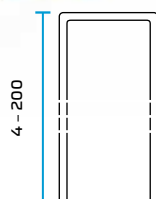
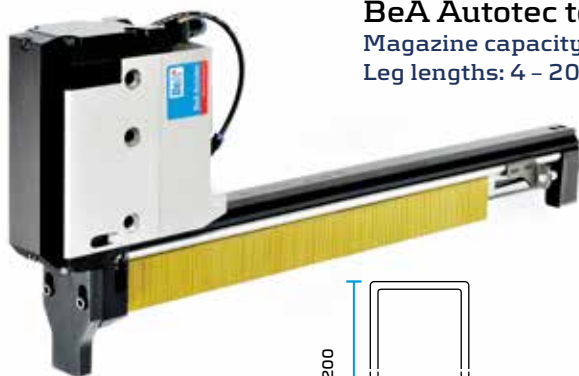

**BeA Autotec tool - long magazine 235 / 245 / 265 / 285**

Magazine capacity: 100 - 500 staples (approx.)  
Leg lengths: 4 - 200 mm

- Placement and stapling possible in any position and orientation
- Various leg lengths can be loaded without further adjustments
- Electronic placement and magazine control
- High speed fastening - frequency up to 10 staples per second
- Multiple mounting options facilitate installation
- Low maintenance
- Long operating life

**Applications:** Prefabricated houses, window and door frames, packaging, furniture, pallets and crates



**BeA Autotec tool – Long magazine unit**

Magazine capacity: 300 – 500 staples  
 Leg lengths: 4 – 25 mm

Stationary unit, available in automatic or foot pedal actuation.  
 Hands free operation facilitates proper feeding and alignment

- Contact actuation
- Foot pedal actuation
- Available as double clinching unit
- Up to 5 tools on one unit

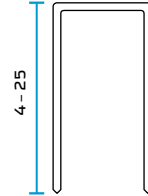

**Applications:** Packaging, blister packaging, low volume assembly

**BeA Autotec Strip Nailer 296 with reloading station 297**

For strip nail type R20 in lengths 130 – 160 mm  
 Ø 3.8 – 5.0 mm

**BeA Autotec Strip Nailer 296**

- Magazine capacity of 2 nail strips
- Magazine control
- "Dry firing" control
- Multi directional nailing possible

**Reloading station 297 with automatic nail feeding**

- Reloading and feeding of the nails happens automatically using a cassette type holding bay for 90 nail strips (approx. 1,800 nails)
- Filling of the nail cassette (straight out of the carton) takes minimal time
- The loading station automatically corrects the position of the nail strip and feeds it correctly into the magazine of the nailer

**Applications:** Crating, heavy duty wooden packaging (pallets etc.) and the prefabricated house industry



Description	Length in mm
R20 3.8 x 130 BK	130
R20 3.8 x 130 BK Screw	130
R20 3.8 x 130 BK Ring	130
R20 3.8 x 130 NK	130
R20 4.2 x 130 BK	130
R20 4.2 x 160 BK	160
R20 4.6 x 145 BK	145
R20 4.6 x 160 BK	160
R20 4.6 x 160 BK Screw	160
R20 4.6 x 160 NK	160



Magazine capacity  
 90 nail strips  
 (1,800 nails)



# Magazine Selection for BeA Autotec

The selection of the magazine depends on:

- Type and available space within the mounting system



- Type of magazine required



- Stapling direction

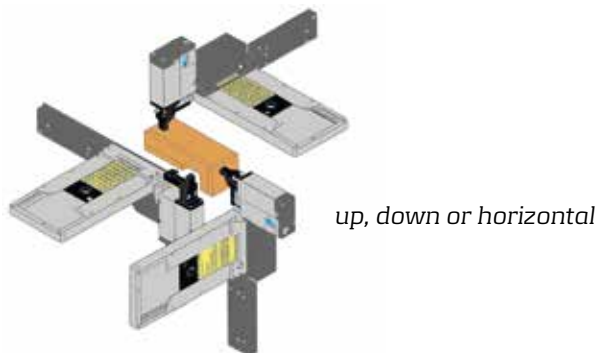

- Available space for reloading

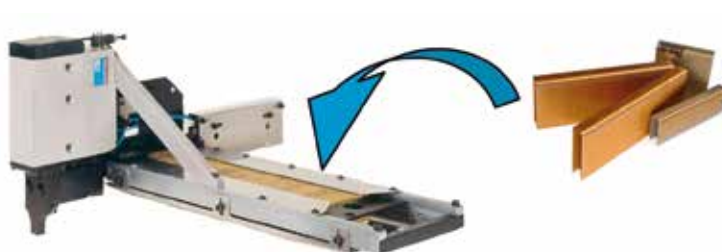



# Selection of nose length

The nose length depends on the height of the workpiece

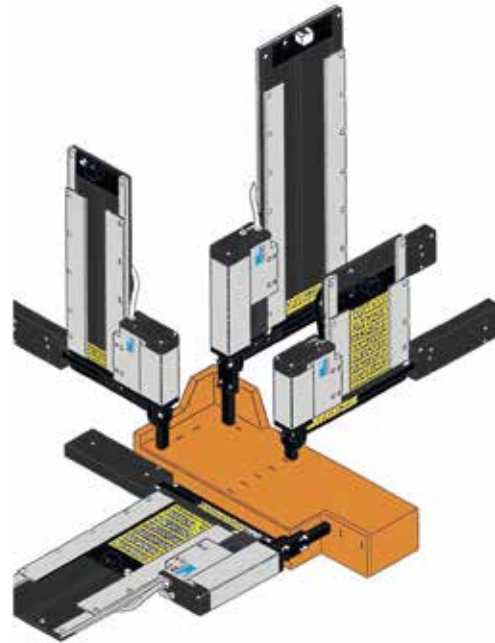

# Magazine types



Long magazine



Side loader



Top loader



Change over cassette

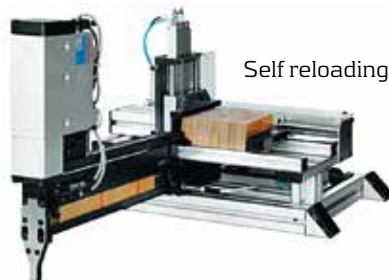

Self reloading system



Reloading station

Please contact our experts with any questions you may have or to enquire about our extensive product range:

+44 (0)1482 88 99 11

## BeA automated fastening systems for pallets and crates

We integrate our custom fit fastening systems into automated production lines for the production of pallets and wooden packaging. We do not only supply the hardware, which are modified coil or strip nailers, but also develop individual solutions in cooperation with our clients and the manufacturer of the production line.

Using flexible production bridges of well known manufacturers, such as **Errebi** and **Rimac** in Italy, **K. Stroj** in Czech Republic and robot systems of the latest generation by **Ekatech** in Sweden – BeA automated fastening systems work reliably and durably. Continuous use is no problem for our tools. Service and maintenance as well as quick replacement are essential for us.

BeA automated solutions can be integrated in nearly every production line. Our experience in the field of industrial fastening solutions is based above all on close cooperation with our customers – to your advantage!

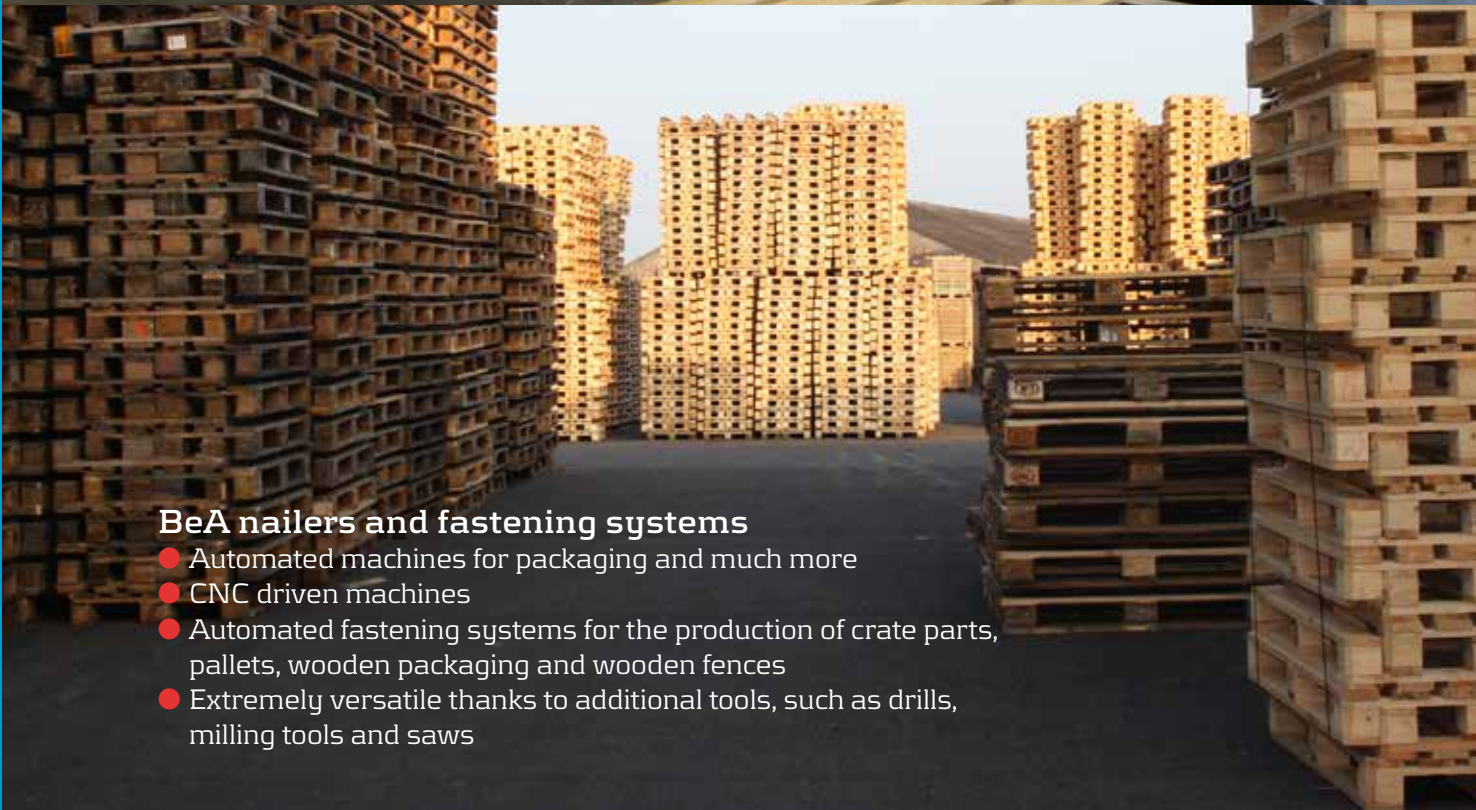

### BeA nailers and fastening systems

- Automated machines for packaging and much more
- CNC driven machines
- Automated fastening systems for the production of crate parts, pallets, wooden packaging and wooden fences
- Extremely versatile thanks to additional tools, such as drills, milling tools and saws



### Our know how – your advantage:

**Perfectly harmonized:** Fastener type – tool – production line. This is the BeA formula for minimal reloading time, longer service intervals, safe working environment and absolute reliability.

**Quick and safe:** Integrated fastening solutions with up to 10 cycles per second. Safety during the working process thanks to the separation of operator and machine.

**Effective and integrated:** A robot system integrates a complete production line. Single operator usage – for handling, controlling, reloading and retooling.

**Productive and Flexible:** In only a few minutes the production lines and robot systems can be adapted. Small batch series and special products do not need to be produced manually any more.



# EKATECH

Whether semi or fully automated production of crate parts, pallets, wooden packaging or fences – an investment ensures higher productivity, better production quality, safer working and more flexibility.



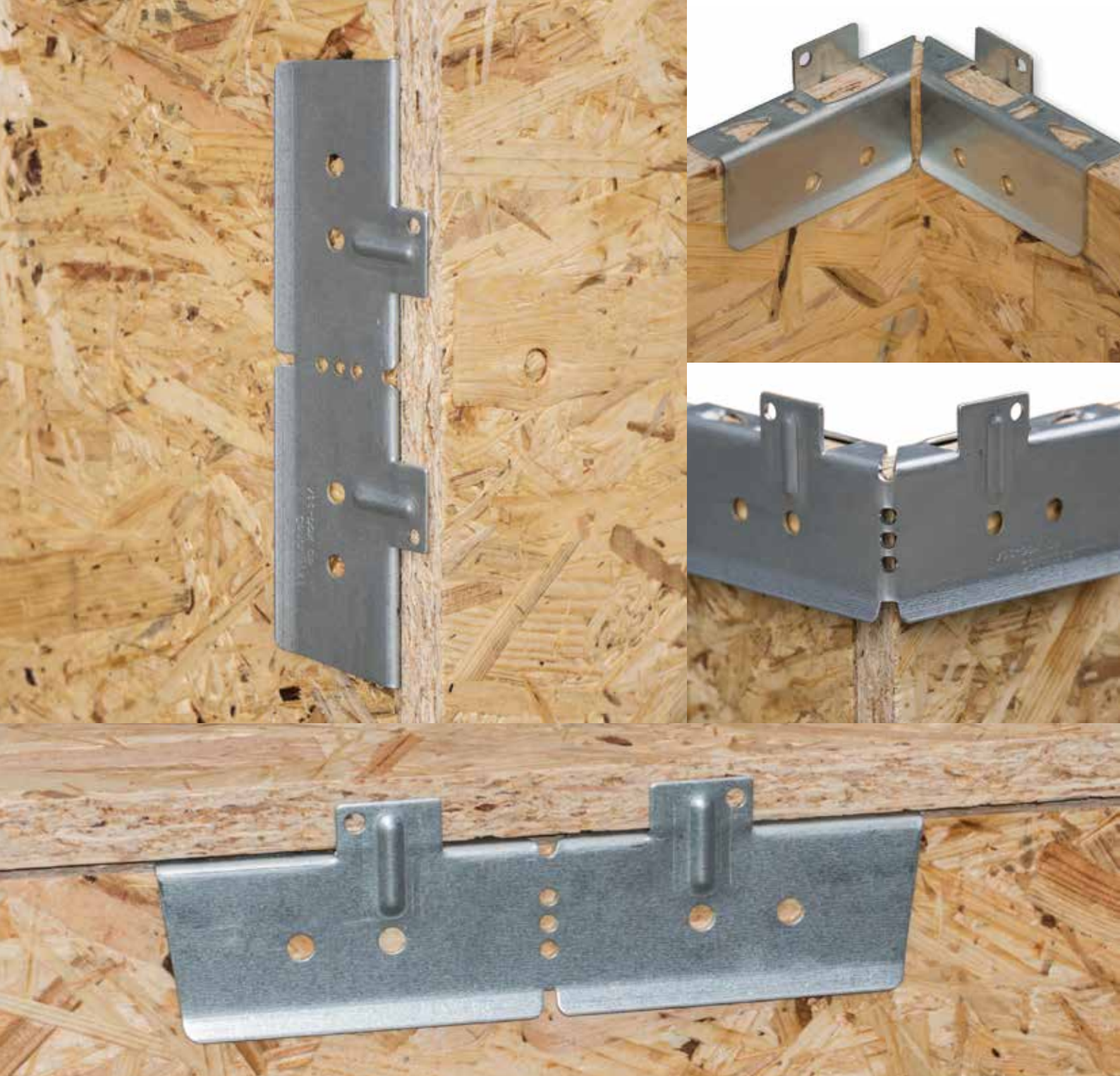

# BeA VTT connectors

For making stable and sturdy transport  
and packaging crates

## BeA VTT connectors

- World first for quick and easy crate assembly
- Only one component for long sides and corners
- Simple to use without tool
- Sturdy hot dip galvanised version, high load bearing capacity
- For 12 and 15 mm board materials e.g. OSB panels, plywood, chipboard, honeycomb core cardboard
- Protected as utility model
- Made in Germany



BeA crate set with BeA VTT connectors



Pallet as a basis with BeA VTT connectors



Simple insertion of the crate sides



The crate can be filled at any time



Fit the BeA VTT connectors at the top



Set the lid in place, seal using packaging strap

## Simple, fast, stable, cost efficient and protected as utility model

- The BeA VTT connector for the production of solid transport packaging crates
- Use of low cost board material (e.g. OSB panels, plywood, chipboard, honeycomb core cardboard)
- Fast construction time (120 sec), significant cost and time saving
- Connectors can be used without the aid of a tool
- No milled, drilled or grooved profiles in the board parts
- Can be reused / mono material recycling

### Attachment of the base connection using BeFIX Screw BeFIX TK 4.5x50/30/7/TX 20











# BeA Compressed Air Accessories

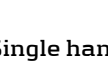

## BeA Compressed Air Accessories

Description	Item No.	Min. order quantity
<b>Single handed couplings</b>		
 1/4" A brass OD	14000256	5
 3/8" A brass OD	14000224	5
 1/2" A brass OD	14000226	5
 1/4" I brass OD	14000198	5
 3/8" I brass OD	14000199	5
 1/2" I brass OD	14000232	5

### Single handed couplings with hose fitting







 6 mm LW brass	14000234	5
 9 mm LW brass	14000236	5
 13 mm LW brass	14000238	5

### Valve

 Valve 3/8" I with 2 couplings	14000200	-
 Valve 3/8" I with 3 couplings	14000201	-

### Hoses and Accessories

 Spiral hose 6 mm I, 7.5 m	14000042	-
 Spiral hose 8 mm I, 7.5 m	14000043	-
 Spiral hose 5 mm I, 7.5 m	14000045	-
 Spiral hose 6.3 mm I, 7.5 m	14000046	-
 Spiral hose 8 mm I, 7.5 m	14000047	-
 PVC hose 6 mm I, 12 mm A, roll 50 m	14000202	-
 PVC hose 9 mm I, 15 mm A, roll 50 m	14000204	-
 PVC hose 12 mm I, 20 mm A, roll 50 m	14000203	-
 Air hose complete. 9 mm I, 15 mm A, 15 m	14000051	-
 30 m hose drum 8.5 mm inner width	14000406	-

Description	Item No.	Min. order quantity
<b>Hose clamps</b>		
 Clamps for hose 11 - 13 mm OD	14000052	10
 Clamps for hose 13 - 15 mm OD	14000053	10
 Clamps for hose 15 - 17 mm OD	14000054	10
 Screw clamps for hose 10 - 16 mm OD	14000055	10
 Screw clamps for hose 12 - 20 mm OD	14000056	10
 Screw clamps for hose 16 - 25 mm OD	14000057	10
 Screw clamps for hose 20 - 32 mm OD	14000058	10

### Teflon sealing tape

 12 mm wide, 12 m long	13301438	-
--	----------	---

### Screw lockings



 Adhesive and sealing compound 50 ml	14000060	-
---	----------	---

### Grease



 O Ring grease 500 ml	14001362	-
--	----------	---

 Frost resistant oil, 1000ml	14000197	-
---	----------	---









### Blow gun

 1/4" Short nozzle	14000365	-
 1/4" Balancer with extension tube	14000366	-

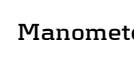
### Balancer

 Lifting capacity 1.0 - 2.0 kg	13301431	-
 Lifting capacity 2.0 - 4.5 kg	13301433	-
 Lifting capacity 6.0 - 8.0 kg	13301435	-

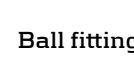
## BeA Compressed Air Accessories

Description	Item No.	Min. order quantity
<b>Maintenance units, block assembly</b>		
 Maintenance unit 1/4"	14000150	-
 Maintenance unit 1/2"	14000152	-
 Pressure regulator 1/4"	14000156	-
 Pressure regulator 1/2"	14000158	-
 Pressure regulator 1/4"	14000159	-
 Pressure regulator 1/2"	14000161	-
 Filter air dryer 1/4"	14000162	-
 Lubricator 1/4"	14000165	-
 Lubricator 1/2"	14000167	-

### Manometer for maintenance units

	40 mm G 1/8"	14000168	-
	50 mm G 1/4"	14000170	-

### Air connectors

	6 mm Inner width brass	14000183	5
	9 mm Inner width brass	14000184	5
	13 mm Inner width brass	14000185	5

### Air connectors

	1/4" Outer diameter steel	14000248	5
	3/8" Outer diameter steel	14000249	5

### Ball fitting

	1/4" Steel	14000505	5
---	------------	----------	---

### Screw in Hose fittings

	1/4" G, 6 mm Inner width brass	14000187	5
	1/4" G, 9 mm Inner width brass	14000188	5
	1/2" G, 13 mm Inner width brass	14000191	5

Description	Item No.	Min. order quantity	
<b>Polyamide gaskets</b>			
	1/8" G, 10 mm I, 15 mm OD	14000192	10
	1/4" G, 13 mm I, 18.5 mm OD	14400063	10
	3/8" G, 17 mm I, 22 mm OD	14000194	10

### Double thread nipples, cylindrical

	1/8" A, 1/4" A, 17 SW, MS	14000061	5
	1/4" A, 1/4" A, 17 SW, MS	14000062	5
	1/4" A, 3/8" A, 19 SW, MS	14000063	5
	3/8" A, 1/2" A, 24 SW, MS	14000064	5
	1/2" A, 1/2" A, 24 SW, MS	14000065	5
	1/4" A, 1/8" A, 17 SW, MS	14000066	5
	3/8" A, 1/4" A, 19 SW, MS	14000067	5
	1/2" A, 3/8" A, 22 SW, MS	14000068	5

### Pressure reduction valves 3/8" with de-airing

	Reduction to 6 bar	14001504	-
	Reduction to 8 bar	14001573	-
	Additional parts for 3/8"	13300854	-
	Additional parts for 1/4"	14000063 + 14000464	-

# BeA Fasteners

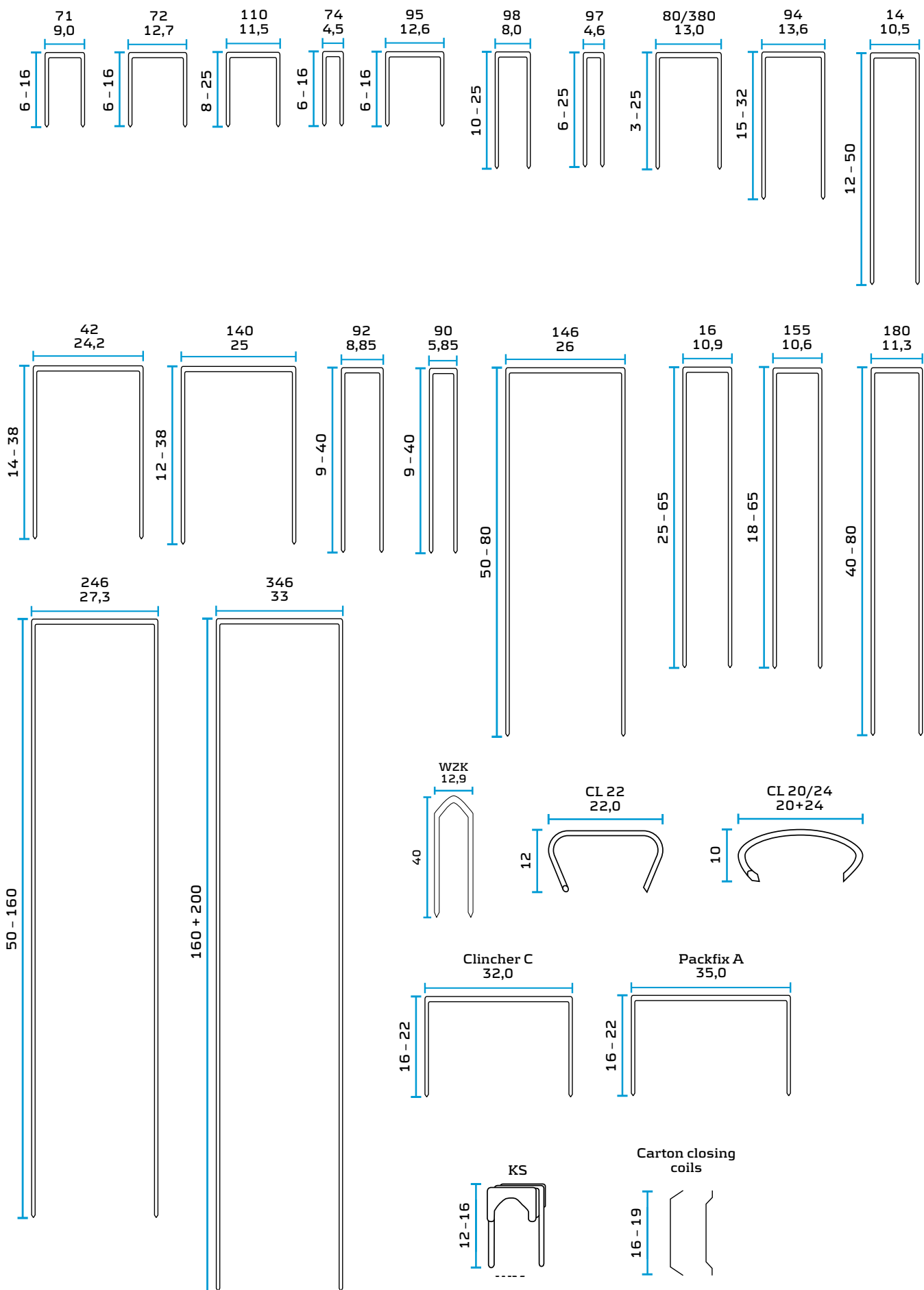

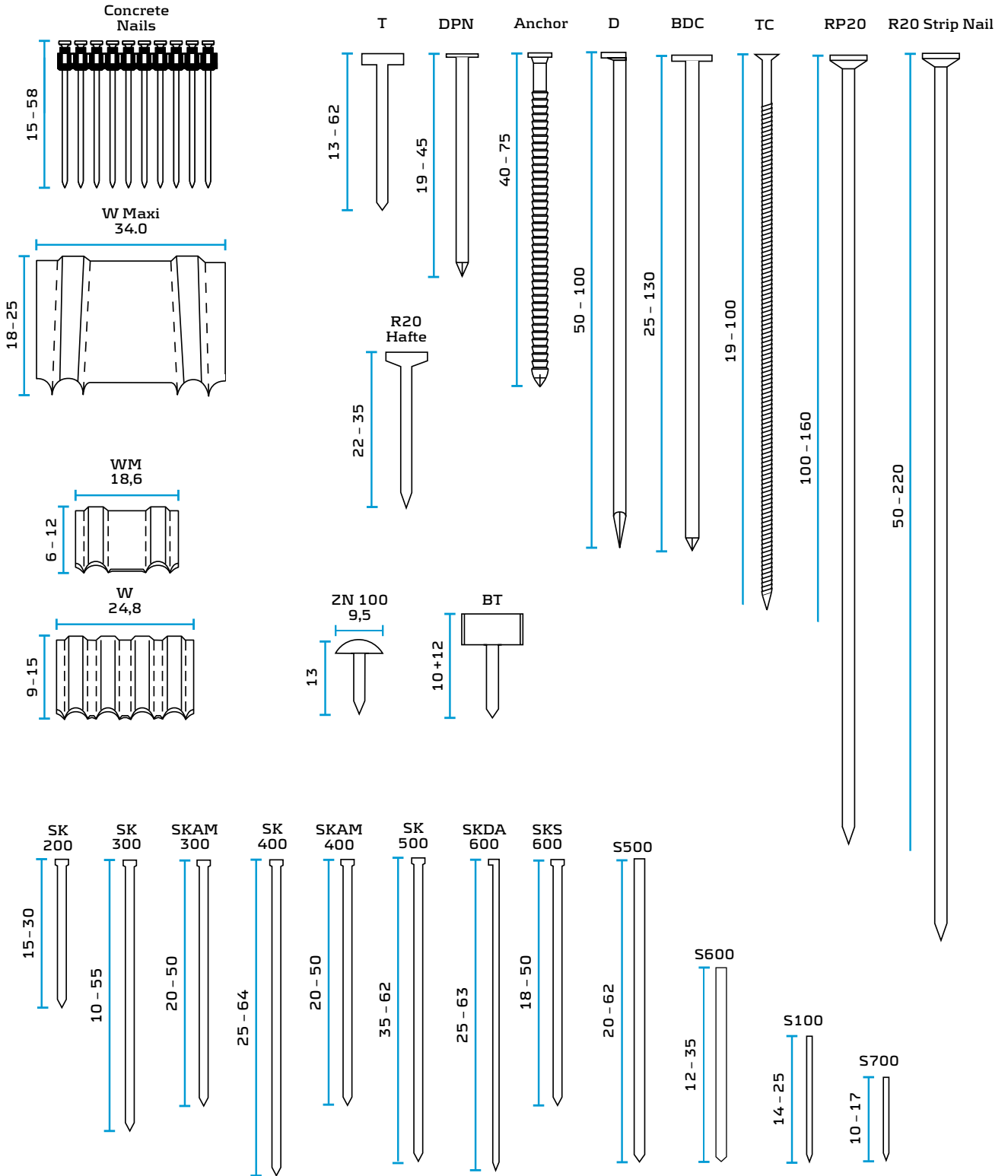

For information  
[www.bea-group.com](http://www.bea-group.com)  
 or call +49 (0)4102 78-445



BeA Fasteners

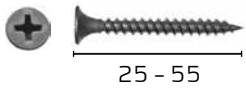

Drywall screw, fine thread

25 - 55

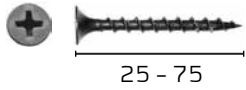

Drywall screw, coarse thread

25 - 75



Fibre cement board screw, fine thread

22 - 45



Fibre cement board screw with Tek drilling point

25



Drywall screw with Tek drilling point, fine thread

35



Timber screw, grey phosphated

25 - 55



Fibre cement board screw with Tek drilling point, fine thread

35 - 45



Fibre cement board screw, fine thread

22 - 45



Fibre cement board screw with Tek drilling point, fine thread

25



Dry wall screw, coarse thread

25 - 55



Ø 3.5 - 10.0 mm

35 - 400

BeFIX chipboard screw/ wood construction screw with countersunk head



Ø 6.0 - 10.0 mm

50 - 400

BeFIX wood construction screws with wafer head

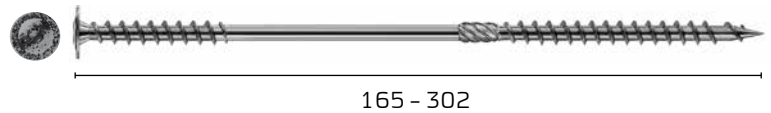

Ø 8.0 mm

165 - 302

BeFIX double thread screw

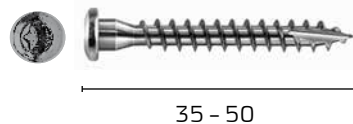

Ø 5.0 mm

35 - 50

BeA Anchor screw for timber connectors

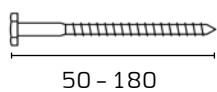

DIN 571, Hexagon head wood screw, electro galvanized

50 - 180

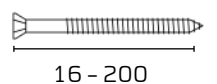

Chipboard screw, TX head, electro galvanized

16 - 200

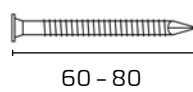

Anchor nail, loose, electro galvanized

60 - 80

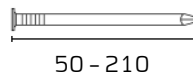

Wire nails, loose, steel bright

50 - 210

## General Terms and Conditions of Business

The following General Terms and Conditions of Business (T&Cs) of BeA GmbH (hereinafter referred to as the "Supplier") form part of the agreement by mutual consent; they take precedence over any deviating terms set by the buyer (hereinafter referred to as the "Customer" or "Buyer"). This shall also apply if the Supplier provides services which deviate from the General Terms and Conditions of the Customer.

### Terms and Conditions of Sale and Delivery

#### 1. Order placement

- 1.1 An agreement shall only enter into effect upon written confirmation by the Supplier or upon execution of an order. Changes, additions and subsidiary agreements to the contract must be made in writing. This shall also apply to this clause.
- 1.2 The Buyer is liable for the accuracy of all documents provided by him, in particular for any drawings, instructions and samples. The Buyer must notify the Supplier of any obvious defects by providing measurements and calculations in good time prior to implementing the order. The Supplier is not obliged to examine the item.
- 1.3 Samples will be provided at additional cost unless otherwise agreed.
- 1.4 Figures, drawings, images and service descriptions provided in brochures, catalogues, price lists or documents relating to the order are approximations in keeping with standard commercial practices.

#### 2. Performance period, impossibility, delay

- 2.1 The delivery dates specified by the Supplier shall be viewed as approximates unless a fixed delivery or performance date has specifically been agreed. A delivery date is considered as met if the goods are handed over to the Customer by the time agreed in Clause 5.2 or upon the Customer receiving notification that the goods are ready to ship.
- 2.2 In the event of subsequent amendments to the contract which could have an effect on the term of the contract, the latter shall be extended accordingly.
- 2.3 If the Supplier is unable to fulfil their obligation to deliver as a result of unforeseen, extraordinary events which, despite taking precautions reasonable for the circumstances in the specific case, are beyond their control - regardless of whether they occur at the Supplier's factory or at the premises of its subcontractors, in particular official interventions, operational disruptions, work disputes, delays to delivery of raw and auxiliary materials or force majeure - the delivery date shall be extended accordingly. If the execution of the contract is unreasonable for any of the parties due to the above-mentioned events, in particular if the execution of the contract is delayed substantially by more than 6 months, that party may request to withdraw from the contract.
- 2.4 If the Supplier does not receive the specific goods for fulfilling an order, or delivery of these is delayed or damaged, he is released from his obligation to supply the sold goods provided that he has taken the necessary steps to ensure timely self-delivery. The Supplier shall be responsible for immediately informing the Buyer in the event of non-availability and proceed with the prompt reimbursement of any services in return already provided.
- 2.5 If the Supplier is at fault for non-compliance with delivery dates or deadlines, the Customer may withdraw from the contract after fruitless expiry of a written, appropriate extension of the deadline. The Buyer may request compensation for damages in accordance with Section 12 of these T&Cs only. The same shall apply for other impossibilities of the Supplier.
- 2.6 In the event of impossibilities of the Supplier, the Buyer shall be obliged to reimburse the Supplier for any services carried out thus far based on the fair market value. The same shall apply if the Supplier is entitled to withdraw from the contract due to contractual or legal guidelines. Additional rights of the Supplier shall remain unaffected.

#### 3. Pricing

- 3.1 Unless otherwise agreed, all prices are understood to be ex-works and exclusive of packaging, shipping, postage and insurance. All prices are quoted exclusive of statutory sales tax.
- 3.2 If prices are not quoted or are to be at "current list prices", the list prices valid at the date of delivery will be charged. If the agreed price is not based on a list price but an agreement between the contractual parties, and the list price, market price or price for a subcontractor service has increased by more than 5% since the point of conclusion of the agreement, the Supplier can request that the agreed price be adjusted accordingly (exemption limit). This shall apply if a delivery term of more than four months is agreed or delivery takes place more than four months after conclusion of the contract for valid reasons outside of the Buyer's control. The preceding provision shall apply for price increases of up to 10%. For greater price adjustments, a new price agreement is required. If the aforementioned comparison price has increased by more than 25% and neither parties agree to a price increase, the Supplier is entitled to withdraw from the contract. The Customer shall have no further rights in this case.

#### 4. Payment terms

- 4.1 Payments are payable upon receipt of invoice and without deduction. Payments made to the Supplier's account within 8 days of receipt of invoice shall receive a 2% discount provided the Buyer is not in default in respect of payment for goods. The Supplier is entitled to send the Customer invoices electronically, i.e. via email.
- 4.2 Should the Supplier become aware after conclusion of the contract of a material adverse change on the part of the Buyer which may endanger his chances of claiming payment, up to the time of his delivery or providing the service agreed he may require the lodgement of a suitable guarantee within a reasonable period or provide his service step-by-step pursuant to Section 232 Para. 1 BGB. The Buyer can assign a qualified guarantor to act as security, to guarantee any claims as a primary liability and who is available for immediate consultation. If the Buyer does not satisfy the Supplier's justifiable demand or does not do so within a reasonable time, the Supplier may terminate the contract. In the event of termination of the contract, the Supplier shall be reimbursed for any preliminary work at the fair market value.
- 4.3 If the Buyer does not make payment in time, despite warning, the Supplier is entitled to discontinue all orders placed by the Buyer in addition to claim to performance and/or other legal or contractual rights.

#### 5. Shipping and transfer of risk

- 5.1 Shipping takes place ex-works. Unless otherwise agreed, the Supplier is not obliged to choose the cheapest shipping option.
- 5.2 Risk shall be transferred to the Customer once the goods have been received by the ordering party. If goods are ready to ship and shipment or space allocation are delayed for reasons outside of the Supplier's control, the risk shall pass to the Buyer upon receipt of notification of readiness for dispatch.

#### 6. Industrial property rights

- 6.1 Any images, drawings and other documents shall remain the property of the Supplier and subject to copyright law; they may not be made available to third parties without the Supplier's consent and must be returned immediately upon request.
- 6.2 If the production of goods based on drawings, samples or other information from Buyer violates the intellectual property rights of third parties, then the Buyer is obligated to release the Supplier from all claims or to compensate him for the damage that he claims to have suffered.

#### 7. Retention of title

- 7.1 The Supplier reserves the title to the delivered goods until all claims have been settled with the Buyer (reserved goods). In the case of payment by means of cheque or bill of exchange, title to the goods is retained until the bill is cleared by the Customer. Cheques will only be accepted on condition of fulfilment and not instead of performance. In the case of current accounts, the retention of title will serve to balance the Supplier's claims. The Buyer is obliged to appropriately insure the reserved goods, at their own expense, against all common risks, particularly fire and theft, and submit proof upon request.
- 7.2 Acquisition of ownership by the Buyer pursuant to Section 950 BGB is not permitted. A potential connection, mixing, filling or manufacturing and processing of the reserved goods with other goods not belonging to the Supplier may take place in the knowledge that the Supplier shall acquire joint property rights of the new item whereby the invoice value of the reserved goods shall correspond to the overall sales value of the new item. The new item shall therefore be considered as reserved goods for the purpose of these conditions and will be stored by the Buyer for the Supplier. Should the Buyer acquire sole ownership of the new item, he shall transfer the co-ownership share to the Supplier in respect of the value of the processed reserved goods.
- 7.3 The Buyer may only sell the reserved goods in the normal course of business and provided he is not in default. The Buyer shall now assign all claims to the Supplier arising as a result of resale to third parties. This assignment occurs only on account of performance. This assignment extends to all future existing claims concerning resale of the reserved goods. If the reserved goods to which we have title are sold by the Buyer together with other goods not delivered or in a processed state by the Supplier, then the receivables ceded to us from the resale will not exceed the invoice value for the reserved goods. In the event of resale of new items of which the Supplier has acquired joint ownership, then the receivables ceded to us shall be the value of the co-ownership share. The assigned claims will serve as security to the Supplier's claims to the same extent as the reserved goods.
- 7.4 The Buyer himself may collect the assigned claims provided he has complied with the payment terms of the business relationship, is not in default and is not subject to insolvency proceedings.

## General Terms and Conditions of Business

- 7.5 Should the Buyer not fulfil their contractual obligations, particularly with regard to delayed payment, the Supplier is entitled to demand temporary return of the reserved goods at the Buyer's expense and without exercising the right of withdrawal or setting a grace period.
- 7.6 In cases where third parties access the reserved goods or claims and securities of the Supplier, particularly in the event of pledging or other enforcement measures, the Buyer must indicate the Supplier's ownership and immediately notify the Supplier and provide the documents necessary for an intervention; this shall also apply to impairment of any other kind. The Buyer shall reimburse the Supplier for the costs of resisting such seizures and claims.
- 7.7 The Supplier is obliged to release at his own discretion any securities that he is entitled to in accordance with the above provisions to the extent that the realisable value of such securities exceeds the receivables to be secured by more than 10 percent.
- 8. Moulds and tools**
- 8.1 The costs for moulds or tools to be prepared will be invoiced pro rata and separately from the cost of the goods
- 8.2 Through remuneration of shares of costs for moulds/tools, the Buyer shall not acquire any rights to these; the moulds/tools shall remain the sole property of the Supplier. The Supplier is obliged to store the moulds/tools on the Buyer's behalf for a duration of one year from the final delivery. Should the Buyer provide notification before expiry of this deadline that they intend to place orders within this additional year, the storage period shall be extended further by one year.
- 8.3 Once this period has expired, the Supplier has free access to the moulds/tools. The Buyer may however acquire the moulds/tools by payment of the full costs.
- 9. Warranty**
- 9.1 If the goods delivered are faulty, the Supplier may then choose to either fulfil the order by remedying the defect or supplying a new product. He is obliged to bear the costs for all expenses, particularly transportation, tolls and material costs, required to remedy the defect as far as these costs are not increased by moving the delivery to a place other than the place of performance unless this complies with the use under the provisions of this contract.
- 9.2 If subsequent performance is not effected within a suitable period of time, i.e. a minimum of 2 weeks, or if the second attempt fails as well, the Buyer is entitled to choose between a reduction in the sale price or withdrawal from the contract.
- 9.3 The warranty obligation shall not apply if the Buyer does not use original parts or fixings and replacement parts approved by the Supplier with regards to the use of staplers and pneumatic nailers. The same shall apply to damages arising as a result of chemical influences on fixings used insofar as these are not foreseeable in the contract.
- 9.4 For defects caused by inappropriate or incorrect use, natural wear-and-tear, improper assembly or operation by the recipient or third party, or by incorrect or negligent treatment, warranty shall also not apply nor for the consequences of incorrect changes by the Buyer or third parties or those carried out without the Supplier's authorisation.
- 9.5 See Section 12 for claims for compensation of damages. Clause 12.5 shall apply for the limitation period of warranty claims.
- 10. Examination and notification obligation**
- 10.1 The Buyer is obliged to inspect the goods immediately upon delivery, and no later than immediately after unloading from the means of transport. Any defects, incorrect deliveries or missing items must be reported immediately. This notification must be made in writing. If the goods are being sent on further by the Buyer, inspection must take place at the initial place of delivery regardless. If own know-how is not sufficient, then an expert must be consulted immediately.
- 10.2 The notification period for non-conforming goods shall be two weeks from the date of delivery or release at the agreed location for defects which are detected in the course of proper inspection, and two weeks from the point of detection for defects that were not immediately apparent (hidden defects).
- 10.3 The Buyer must allow the Supplier sufficient opportunity to satisfy itself of the defect and notify them of the place where the goods are located and provide access to the goods. If this obligation is violated or the goods have been further processed, sent on or modified, these goods shall be considered approved. In the event of hidden defects, the Buyer shall bear the burden of proof that the goods were in a defective condition at the time of delivery.
- 10.4 Goods shall be considered approved if violation of obligation occurs pursuant to 11.1 to 11.3, and in the event of incorrect or non-timely notification of such defects that could have been detected upon proper inspection. Section 377 HGB shall apply unless otherwise stipulated in these T&Cs.
- 11. Compensation for breaches of duty**
- 11.1 The Supplier is liable without limitation in accordance with legal guidelines for damages occurring as a result of wilful intent or gross negligence. Excluded hereto is contractual violation due to gross negligence by simple vicarious agents, whereby liability shall be limited to predictable and typically occurring damage.
- 11.2 The Supplier shall be liable for damages from simple negligence if this breaches a material contractual obligation. Material contractual obligations are particularly those which are required in order to achieve the purpose of the contract and on which the customer may rely. In this instance, liability is limited to predictable and typically occurring damage. This liability is limited to a maximum amount of 2500 euros. This maximum liability amount shall also apply once more in the event of multiple breaches of duty (maximum overall amount).
- 11.3 Pursuant to legal guidelines, the Supplier shall be liable without limitation for damages to loss of life, bodily injury or damage to the health of a person. The Supplier's mandatory liability pursuant to product liability law shall also remain unaffected. Limitations of liability pursuant to Clauses 12.1 and 12.2 shall not apply.
- 11.4 Unless otherwise stipulated, compensation claims of the Buyer shall be excluded. The provisions in this clause shall also apply to non-contractual claims for damages as well as in favour of employees and other vicarious agents of the Supplier.
- 11.5 Excluded herewith are cases in which the Supplier is liable without limitation pursuant to the provisions in Section 12, whereby all warranty claims shall become statute-barred within one year as of the start of the statutory limitation period. This shall also apply for subsequent claims for defects. The statute of limitations in the event of a delivery recourse according to §§ 478, 479 BGB remain unaffected. This lasts for 2 years.
- 12. Applicable law, place of delivery, court of jurisdiction**
- 12.1 German law shall apply for all legal obligations and their implementation as well as any claims which may arise under exclusion of the UN Convention on the International Sale of Goods.
- 12.2 The place of fulfilment for all legal obligations is BeA GmbH.
- 12.3 The place of jurisdiction for any disputes arising from this contract is Hamburg. The Supplier is entitled to resolve disputes at the court of his registered offices.
- 13. Effectiveness in the event of partial invalidity, offsetting**
- 13.1 Should individual provisions of these contractual conditions be or become invalid, this shall not affect the validity of the other provisions. This ineffective provision shall be replaced by one which most closely resembles the originally intended purpose of the ineffective provision.
- 13.2 With regards to claims by the Supplier, the Buyer is not entitled to make deductions to payment of the purchase price or other claims or connection with the contract or exercise a right of retention unless this claim is known, undisputed or legally recognised. He is only authorised to effect a lien only, as far as his counterclaim is based on the same contractual relationship.
- 14. Special conditions for repairs**
- Repairs which do not come under the warranty in Section 10 are subject to the following conditions in addition to Section I. Insofar as the following provisions deviate from those stipulated in Section I, the following provisions apply.
- 15. Costs for non-executed orders**
- If a repair cannot be performed because the fault cannot be determined under observation of proper engineering standards or the order was withdrawn during implementation, the Buyer shall receive an invoice for any costs incurred.
- 16. Remuneration of a cost estimate**
- If a cost estimate is provided at the Buyer's request, they must remunerate any time-related costs which arise.
- 17. Extended lien on movable items**
- 17.1 The Supplier shall be entitled to a contractual right of lien on the Customer's item in its possession. The right of lien may also be claimed on account of claims arising from earlier work, replacement part deliveries or other services insofar as they relate to the item. For other claims arising from the business relationship, the right of lien is only valid insofar as these are undisputed or legally binding.
- 17.2 If the item is not collected within 4 weeks from the date of the collection request, the Supplier may charge a storage fee upon expiry of this period. If no collection is made after 3 months from the date of the collection request, the Supplier is no longer obliged to store the item and is not liable for minor negligent damage or destruction. The Buyer must be sent a due notice one month prior to expiry of this period. The Supplier is entitled to sell the item at market value upon expiry of this period in order to cover costs. The Buyer shall reimburse any loss in value.
- 18. Retention of title**
- 18.1 Unless spare parts etc. assembled within the scope of repair work become integral parts, the Supplier retains title to any assembled parts until all its claims from the existing contract have been settled.
- 18.2 Should the Buyer be in default, the Supplier may demand that the Buyer return the item to disassemble the built-in parts. The Buyer shall bear the costs of return and disassembly.
- 18.3 Should the Buyer conduct the repair, they must give the Supplier the opportunity to disassemble the item at the Buyer's premises. Labour and toll costs incurred shall be borne by the Buyer.

Ahrensburg, 1 September 2015



THE POWER OF FASTENING

**BeA GmbH**  
**Industrial Fastening Systems**

Bogenstraße 43 - 45, 22926 Ahrensburg  
Germany  
Tel. +49 (0) 4102 78 - 445  
info@bea-group.com



[www.bea-group.com](http://www.bea-group.com)

